

HANDBOOK

An Introductory Guide to the Identification of Small Arms, Light Weapons, and Associated Ammunition

Edited by N.R. Jenzen-Jones and Matt Schroeder



A publication of the Small Arms Survey with support
from the Office of Weapons Removal and Abatement of
the US Department of State

Copyright

Published in Switzerland by the
Small Arms Survey

© Small Arms Survey, Graduate Institute of
International and Development Studies,
Geneva 2018

First published in November 2018

All rights reserved. No part of this publication
may be reproduced, stored in a retrieval system,
or transmitted, in any form or by any means,
without the prior permission in writing of the
Small Arms Survey, or as expressly permitted by
law, or under terms agreed with the appropriate
reprographics rights organization. Enquiries concern-
ing reproduction outside the scope of the
above should be sent to the publications coordi-
nator, Small Arms Survey, at the address below.

Small Arms Survey
Graduate Institute of International and
Development Studies
Maison de la Paix
Chemin Eugène-Rigot 2E
1202 Geneva
Switzerland

The Small Arms Survey takes no position
regarding the status or name of countries or
territories mentioned in this publication.

Fact-checking: Lisa Bjork, Timothy Jolin, and
Natasia Kalajdziovski

Copy-editing: Fiona O'Brien

Design: Rick Jones (rick@studioexile.com)

Layout: Julian Knott (www.julianknott.com)

Infographics and illustrations: Daly Design
(studio@dalydesign.co.uk)

Cartography: Jillian Luff, MAPgrafix
(www.mapgrafix.com)

Proofread: Stephanie Huitson
(readstephanie@gmail.com)

Production: Olivia Denonville with
Rebecca Bradshaw

Communications coordination: Emilia Dungal

Printed in France by Gonnet

ISBN: 978-2-940548-55-2

Cover photo: see information p. 85

About the Small Arms Survey

The Small Arms Survey is a global centre of excellence whose mandate is to generate impartial, evidence-based, and policy-relevant knowledge on all aspects of small arms and armed violence. It is the principal international source of expertise, information, and analysis on small arms and armed violence issues, and acts as a resource for governments, policymakers, researchers, and civil society. It is located in Geneva, Switzerland, and is a project of the Graduate Institute of International and Development Studies.

The Survey has an international staff with expertise in security studies, political science, law, economics, development studies, sociology, and criminology, and collaborates with a network of researchers, partner institutions, non-governmental organizations, and governments in more than 50 countries.

For more information, please visit: www.smallarmssurvey.org.

Small Arms Survey
Maison de la Paix
Chemin Eugène-Rigot 2E
1202 Geneva, Switzerland

p +41 22 908 5777

f +41 22 732 2738

e sas@smallarmssurvey.org

w www.smallarmssurvey.org

About the authors

N.R. Jenzen-Jones is a military arms and munitions specialist and intelligence analyst focusing on current and recent conflicts and emergent technologies. He is the director of Armament Research Services (ARES). He has produced extensive research and analysis on a range of small arms and light weapons and small- and medium-calibre ammunition issues as well as on conventional arms proliferation. He has also produced numerous technical assessments of other types of weapons, including incendiary weapons, cluster munitions, and indirect-fire artillery weapons. Mr Jenzen-Jones' other research fields include the exploitation of technical intelligence to support counter-piracy, counter-narcotics, and the use of explosive weapons in populated areas (EWPA). He is a certified armourer and ammunition collector, and a member of several international professional associations and societies including the International Ammunition Association, the European Cartridge Research Association, the International Ballistics Society, the Society for Libyan Studies, and the Ordnance Society.

Matt Schroeder is a senior researcher at the Small Arms Survey where he studies the arms trade, arms export controls, and the illicit proliferation of small arms and light weapons. He previously served as the director of the Arms Sales Monitoring Project at the Federation of American Scientists. Mr Schroeder is the author of *The MANPADS Threat and International Efforts to Address it* (Washington, DC: FAS, 2013), and co-author of *The Small Arms Trade* (Oxford: Oneworld Publications, 2007). He has also written for *Arms Control Today*, *Defense News*, *Defense Technology International*, *Disarmament Forum*, *Foreign Policy*, and *Jane's Intelligence Review*, among other publications. He holds a bachelor's degree in history from Wittenberg University and a master's degree in international security policy from Columbia University's School of International and Public Affairs.

Jonathan Ferguson is a technical specialist with ARES, and the Keeper of Firearms and Artillery at the National Firearms Centre of the Royal Armouries in Leeds, United Kingdom. He is a specialist in the identification of small arms and light weapons, and routinely advises academic, military, and law enforcement clients. Mr Ferguson has published numerous articles and reports, and is working on two books for publication in 2018. His research interests include the use and effects of firearms, including historical wound ballistics, the depiction of firearms in folklore and popular culture, and legacy small arms in contemporary conflict.

Nicolas Florquin is the research coordinator and a senior researcher at the Small Arms Survey. He coordinates projects on armed actors and illicit flows of arms and ammunition in a variety of settings. He previously worked for Geneva Call, an organization specializing in engaging with non-state armed groups on humanitarian issues, and for the United Nations Group of Experts on Liberia. He holds a master's of public administration from the Middlebury Institute of International Studies at Monterey.

Anthony G. Williams was the long-time editor of *IHS Jane's Weapons: Ammunition*, the international reference guide to military and law enforcement ammunition, and is a contributing technical specialist with ARES. He has been collecting and researching ammunition for more than four decades, with a particular interest in small arms and automatic cannon ammunition, the guns that fire it, and how they are employed. He has written or co-authored several books on arms and ammunition as well as numerous magazine articles, and is editor of *The Cartridge Researcher*, the monthly bulletin of the European Cartridge Research Association. Mr Williams continues to produce substantial original research with ARES.

Acknowledgements

The authors and editors would like to extend their sincerest thanks to the many people who assisted with this project over several years. These individuals include Tom Peter Beris (World Customs Organization), Kevin Billingham, Peter Bouckaert (Human Rights Watch), Brian Castner (Amnesty International), C.J. Chivers (*The New York Times*), Alexander Diehl, Oykun Eren, Jim Geibel, Federico Graziano, Paul Holtom (Small Arms Survey), John Ismay (Amnesty International), G. Hays (Armament Research Services—ARES), Richard Jones, Benjamin King (Small Arms Survey), Shelly Kittleson, Ivan Kochin, Yuri Lyamin (ARES), Nicolas Marsh, Ian McCollum (ARES), Glenn McDonald (Small Arms Survey), Hans Migielski (ARES), Kristóf Nagy, Vadim Naninets, Magnus Palmér (Saab), Steven Pavlovich (Western Australia Police Force), Maxim Popenker, Adam Rawnsley (The Daily Beast), Graeme Rice (ARES), Natalie Sambhi, Jim Schatz, Michael Smallwood (ARES), Jerry Smith (ARES), Kurt Stancl (Bear Arms), Robert Stott (AK-47 Catalog book series), Drake Watkins, Michael Weber (ARES), and Galen Wright (ARES). Whether by contributing images, information, or technical expertise, or by assisting in the informal or formal review processes, each of these individuals has shared their knowledge and insights. Several others, who have declined to be named for reasons of privacy or security, also provided assistance.

The authors and editors would also like to extend special thanks to the staff at the National Firearms Centre of the Royal Armouries in Leeds, United Kingdom, for providing first-hand access to its substantial and impressive collection of modern and historical firearms for research, reference, and photographic purposes.

Publication of this Handbook was made possible thanks to financial support from the Office of Weapons Removal and Abatement of the US Department of State.

Using this Handbook

It is important to note that arms and ammunition identification is a very broad field, filled with many unknowns, errors, and disinformation. Arms and ammunition identification is also a very dynamic field, with new information frequently coming to light. This Handbook is intended only as an introduction to the practice and techniques of arms and ammunition identification. It is not a comprehensive list of identification techniques, or types or characteristics of specific arms and ammunition.

Most organisations and individuals do not need to identify weapons on sight; the real task of identification can often be undertaken by specialists later. What is important is to provide those specialists with relevant information, such as clear photographs and detailed records of the item's characteristics. To this end, this Handbook is intended to enable the reader to recognize important information and record it accurately, and also to classify and identify small arms, light weapons, and their ammunition according to their physical features and markings. The identification of a particular item using this guide should be considered tentative until a specialist has confirmed the identification.

Disclaimer

The information in this Handbook is provided for informational purposes only. Arms or munitions of any variety should not be handled without the correct training, and then only in a manner consistent with such training. Subject matter experts, such as armourers, ammunition technical officers, and explosive ordnance disposal specialists should be consulted before interacting with arms or munitions. Individuals must also make a full and informed appraisal of the local security situation before conducting any research related to arms or munitions.

The Small Arms Survey (including its employees and consultants) shall not be held responsible for any damage, of whatever nature, arising from the direct or indirect use of this Handbook, including any damage, of whatever nature, that may be incurred by third parties.

Table of contents

List of boxes, figures, maps, and tables	14
Abbreviations and acronyms	18
Arms-related abbreviations and acronyms	18
Munitions-related abbreviations and acronyms	20
Other abbreviations and acronyms	22
Chapter 1: Small Arms Identification: An Introduction	25
Introduction	26
Terms and definitions	27
Classifying and identifying arms and ammunition	30
Level 1: Class	31
Level 2: Group	33
Level 3: Type	34
Level 4: Make, manufacturer, model, and variant	35
Level 5: Additional information	36
Identifying weapons and analysing arms flows: an overview	36
Identifying the make, model, and variant of weapons and ammunition	36
Mapping the chain of custody	38
Chapter 2: Understanding the Trade in Small Arms: Key Concepts	45
Introduction	46
The authorized trade	46
Types of transfers	46
The transfer chain	47
Authorized but illicit	48
The illicit trade in small arms	48
Diversion of legal holdings	50
Illicit production of small arms	55
Recirculation of illicit weapons	57
Conclusion	58

Chapter 3: Weapons Identification: Small Arms	61
Introduction	62
History and technical development	62
Firearms: a brief description	62
Handguns	67
Sub-machine guns	67
Shotguns	70
Rifles	72
Machine guns	78
Physical features	82
Stocks, butt-stocks, and fore-ends	83
Barrels and muzzle attachments	86
Magazines, drums, belts, and clips	91
Finishes	96
Weapon markings	100
Make, manufacturer, factory, arsenal, and country markings	103
Model and calibre designations	107
Serial numbers and date markings	110
Selector, sight, and safety markings	116
Proof, inspection, and acceptance marks	119
Import and other markings	121
Feed devices	123
Packaging and documentation	125
Ancillaries and accessories	127
Chapter 4: Weapons Identification: Small-calibre Ammunition	131
Introduction	132
Small-calibre ammunition: an overview	132
Describing and identifying small-calibre ammunition	137
Cartridge designation	138
Calibre	138
Country of origin, make, manufacturer, and year of production	140
Functional type	141
Physical characteristics	143
Cartridge case type and shape	143
Case composition	146
Projectile shape, weight, and jacket	149
Crimping, cannelures, and fluting	151

Markings	153
Headstamps and primers	153
Case markings (other)	157
Projectile colouration and markings	158
Sealants	161
Packaging	161

Chapter 5: Weapons Identification: Light Weapons and their Ammunition

167

Introduction	168
History and technical development	168
Heavy machine guns	168
Light cannon	170
Shoulder-fired grenade launchers	171
Auxiliary grenade launchers	173
Crew-served grenade launchers	175
Light and medium mortars	177
Recoilless weapons	179
Rocket launchers	181
Anti-tank guided missile systems	182
Man-portable air defence systems	184
Physical features	186
Bodies and receivers	186
Baseplates	188
Barrels and launch tubes	189
Feed devices	189
Accessories	190
Markings	190
Ammunition for light weapons	195
Cartridges for HMGs, anti-tank rifles, and AMRs (20 mm or less)	195
Light cannon cartridges (20 mm – <57 mm)	197
Grenade launcher cartridges	201
Light and medium mortar projectiles	209
Recoilless weapon projectiles	214
Unguided rockets	219
Guided missiles	221
Packaging and documentation	224

Chapter 6: Weapons Identification: Other Small Arms and Light Weapons	231
Introduction	232
Improvised and craft-produced weapons	232
Types of improvised and craft-produced small arms and light weapons	234
Identifying improvised and craft-produced firearms	247
Converted and ‘reactivated’ weapons	249
Overview of converted weapons	249
Identifying converted weapons	252
Overview of reactivated weapons	252
Identifying reactivated weapons	253
Improvised and craft-produced ammunition	256
Muzzle-loading firearms	260
Overview of muzzle-loading firearms	260
Identifying muzzle-loading firearms	261
Chapter 7: Gathering Arms and Ammunition Data in the Field: Advice for Researchers	263
Introduction	264
Safety considerations	265
Small arms and light weapons	266
Explosive ordnance	267
Cartridge-based ammunition	269
Principal tools and practices for field research on small arms and light weapons	270
Fieldwork techniques	270
Site exploitation	271
Potential sensitivities regarding arms and ammunition information gathering	276
Photographic considerations	277
Case study: AK-103 and F2000 self-loading rifles in Gaza	281
1. Lead generated from open-source intelligence	281
2. Preliminary identification	281
3. Achieving positive identification	283
4. Identifying the variant of the AK-103, and the source of the rifles	284
5. Mapping the chain of custody	286
6. Assessing further proliferation and providing context	286

Chapter 8: Analysing Arms Flows: Authorized Transfers	291
Introduction	292
Sources of data on authorized small arms transfers	292
Analysing national reports	294
Analysing UN Comtrade and other customs data	297
Analysing the UN Register of Conventional Arms (UNROCA)	308
Analysing social media	313
Analysing tenders and contract award notices	316
Conclusion	318
 Chapter 9: Analysing Arms Flows: Illicit weapons	 321
Introduction	322
Analysing data on border seizures	322
Analysing data on local seizures	323
Other sources of government data	329
Shipping and storage documents	330
Analysing social media	331
Conclusion	336
 Bibliography	 339

List of boxes, figures, maps, and tables

Boxes

1.1	Developing arms and ammunition baseline assessments	37
1.2	Arms tracing	38
2.1	International efforts to curb illicit arms flows	49
2.2	Diversion of arms and ammunition in peace operations	52
2.3	Firearms used in elephant and rhino poaching in Africa	54
3.1	Myths and misconceptions: 'AK-47'	77
3.2	Myths and misconceptions: 'assault weapon'	81
3.3	Myths and misconceptions: 'silencers'	90
3.4	Myths and misconceptions: 'clip' or 'magazine'?	96
3.5	Myths and misconceptions: 'golden guns'	99
3.6	Counterfeit and reproduction firearms	101
3.7	State participation in the small arms and light weapons supply chain	107
4.1	Unmarked, mismarked, and counterfeit headstamps	156
4.2	Myths and misconceptions: 'poisoned bullets'	162
5.1	FCSs and airburst munitions for AGLs	176
5.2	Myths and misconceptions: 'rocket launchers' versus 'recoilless weapons'	182
5.3	Common types of explosive warheads used in light weapons ammunition	205
5.4	US ammunition marking colour scheme	213
5.5	RPG-7 projectile designations	219
6.1	3D printing and improvised firearms	239
6.2	'Artisan' production	242
6.3	Counterfeit weapons	246
6.4	Capability	255
7.1	Unload and clear procedures	267
8.1	Tips for researchers: analysing data on authorized arms flows	318
9.1	MANPADS and social media	333
9.2	Tips for analysing data on illicit small arms and light weapons	335

Figures

1.1	The different levels of ARCS classification fidelity	31
1.2	Description of a weapon using ARCS	32
1.3	Selected markings on a Heckler & Koch HK417 self-loading rifle	39
2.1	Example of an arms transfer chain	48
2.2	Points of potential diversion in a typical transfer chain	50
3.1	Typical features of a modern military rifle	63
3.2	Typical features of a modern handgun	64
3.3	The build-up of gas pressure behind a projectile during the firing sequence of a firearm	65
3.4	Rifled and smooth-bore barrels	65
3.5	Conventional grooved rifling (left) and octagonal polygonal rifling (right)	65
3.6	Typical arrangement of a modern self-loading pistol, showing some internal components	68
3.7	Typical features of a break-action shotgun	71
3.8	Typical features of a pump-action shotgun	71
3.9	Typical features of a modern military rifle	82
4.1	Cross-section of a 7.62 × 51 mm cartridge	133
4.2	Basic composition of a 7.62 × 39 mm cartridge	138
4.3	Distance measured between the lands (X) or grooves (Y) of a rifled barrel	139
4.4	Examples of common projectile jacket configurations	150
4.6	Selected NATO and associated military projectile colour codes	160
4.7	Examples of the different colours, types, and application locations of sealants	161
4.8	Typical marking format on Eastern Bloc inner packaging (metal tin) containing Soviet 7.62 × 54R mm light ball cartridges	164
5.1	Some of the key physical features of grenade launcher ammunition	206
5.2	Sample markings on a Bulgarian Arsenal RLV-HEF-1 40 × 46SR mm HE-FRAG cartridge	208
5.3	Arrangement of a typical mortar projectile	209
5.4	Arrangement of a typical fin-stabilized rocket	220
5.5	Markings on a Russian 9M113 Konkurs ATGM	223
5.6	Markings on outer packaging for a Russian 9M113 Konkurs ATGM	225
5.7	Delivery documentation (packing list) for 9P135M-1 ATGW launchers delivered to Libya in the late 1980s	229
7.1	Markings on AK-type rifles	280

8.1	Excerpt from Albania's national report on exports of military goods, 2014	295
8.2	Excerpt from the EU's annual report on imports and exports of military goods and technologies, 2015 (exports to Iraq)	296
8.3	Global trends in small arms imports by region, as reported to UN Comtrade (USD million), 2001–14	301
8.4	Data on small arms exports reported by China (top) and by four trade partners in Africa (bottom), 2010–14	306
8.5	Excerpts from the Russian Federation's submission to the UN Register regarding conventional arms exported in 2009 (top) and 2012 (bottom)	309
8.6	Excerpt from the Czech Republic's submission to the UN Register regarding small arms exported in 2010	310
8.7	US Defense Department contract award notice regarding the procurement of 40 mm grenade launchers for Iraq, 2016	317

Maps

7.1	Mapping the proliferation of AK-103 type rifles connected to Libya	289
------------	--	-----

Tables

1.1	Common small arms groups and subgroups	33
1.2	Common munitions groups and subgroups (land)	34
1.3	Using this Handbook to identify arms and track arms flows	41
4.1	Dominant rifle and machine gun cartridges in global military service	134
4.2	Selected common pistol cartridges worldwide	136
4.3	Purposes and users of ammunition by functional type	142
4.4	Selected Warsaw Pact projectile colour codes	159
4.5	Selected NATO and associated military projectile colour codes	160
5.1	Selected HMG cartridges in military service	195
5.2	Dominant light cannon cartridges in global military service	197
5.3	Selected grenade launcher cartridges in global military service	203
5.4	Selected marking colours on US ammunition	213
8.1	Sources of data on authorized transfers	293
8.2	EU Common Military List, categories 1 to 4	296
8.3	Strengths and limitations of national reports	297

8.4	Select Harmonized system (HS) commodity categories that include small arms, light weapons, ammunition, parts, and accessories	298
8.5	Value of small arms supplied to the Americas, by subregion, as reported to UN Comtrade (USD million), 2001–14	302
8.6	Exports of military firearms and other items from the United States as recorded under HS code 930190, 2006–15	303
8.7	Data on weapon sights imported by Chile, Peru, and Uruguay, 2007–10	304
8.8	Strengths and limitations of UN Comtrade	307
8.9	Strengths and limitations of the UN Register of Conventional Arms	311
8.10	Strengths and limitations of using social media to research arms flows	315
9.1	Small arms taken into custody by US CBP, 2009–11	324
9.2	Firearms taken into custody by the LAPD, 2009	328

Abbreviations and acronyms

Arms-related abbreviations and acronyms

AGL	Automatic grenade launcher
AK	Avtomat Kalashnikova ('Kalashnikov automatic rifle')
AKM	Avtomat Kalashnikova Modernizirovanny ('Kalashnikov automatic rifle, modernised')
AK-74	Avtomat Kalashnikova obraztsa 1974 ('Kalashnikov automatic rifle, model of 1974')
AK-74M	Avtomat Kalashnikova obraztsa 1974 Modernizirovanny ('Kalashnikov automatic rifle, model of 1974, modernised')
AMR	Anti-materiel rifle
ATGM	Anti-tank guided missile
ATGW	Anti-tank guided weapon
ATR	Anti-tank rifle
CZ	Česká Zbrojovka Uherský Brod ('Czech Arms Factory, Uherský Brod')
DA	Double-action*
DA/SA	Double-action / single-action*
DGI	Direct gas impingement*
DShK	Degtyareva-Shpagina Krupnokalibernyy ('Degtyareva-Shpagina large calibre')
DShKM	Degtyareva-Shpagina Krupnokalibernyy Modernizirovanny ('Degtyareva-Shpagina large calibre, modernised')
FAL	Fusil automatique léger ('light automatic rifle')
FCS	Fire control system
FN Herstal	Fabrique Nationale de Herstal ('National Factory, Herstal')
GMG	Grenade machine gun
GPMG	General-purpose machine gun (also 'MMG')
HMG	Heavy machine gun
HK	Heckler & Koch

IZHMASH	ИЖМАШ; Izhevskiy Mashinostroite Inyy Zavod ('Izhevsk Machine-Building Plant')
KPV	Krupnokalibernyy Pulemet Vladimirova ('Vladimirova large calibre machine gun')
LMG	Light machine gun
LSW	Light support weapon
MAG	Mitrailleuse d'appui général ('general-purpose machine gun')
MANPADS	Man-portable air defence systems
MANPATS	Man-portable anti-tank systems (also known as 'MPATS')
MBRL	Multiple-barrel rocket launcher
MMG	Medium machine gun
NSV	Nikitina-Sokolova-Volkova (these are the names of the weapon's primary designers)
NSVT	Nikitina-Sokolova-Volkova Tankovyy ('NSV tank machine gun')*
PDW	Personal defence weapon
PK	Pulemet Kalashnikova ('Kalashnikov machine gun')
PKM	Pulemet Kalashnikova Modernizirovanny ('Kalashnikov machine gun, modernised')
PKT	Pulemet Kalashnikova Tankovyy ('Kalashnikov tank machine gun')*
PM	Pistolet Makarova
PSL	Puşcă Semiautomată cu Lunetă ('semi-automatic sniper rifle')*
RPD	Ruchnoy Pulemyot Degtyaryova ('Degtyarev light machine gun')
RPG	Ruchnoy Protivotankovyy Granatomyot ('hand-held anti-tank grenade launcher') or Reaktivnaya Protivotankovaya Granata ('anti-tank rocket launcher')
SA	Single-action*
SACLOS	Semi-automatic command to line-of-sight
SAM	Surface-to-air missile (when man-portable, known as MANPADS)
SAW	Squad automatic weapon
SKS	Samozaryadnyy Karabinsistemy Simonova ('Simonov self-loading carbine')
SMAW	Shoulder-Launched Multipurpose Assault Weapon

SMG	Sub-machine gun
SPG	Stankovyy Protivotankovyy Granatomyot ('heavy anti-tank grenade launcher')
SVD	Snayperskaya Vintovka Dragunova ('Dragunov sniper rifle')
TT	Tokarev-Tula
ZPU	Zenitnaya Pulemetnaya Ustanovka ('anti-aircraft machine gun system')*

Munitions-related abbreviations and acronyms

ABM	Airburst munitions
ACP	Automatic Colt Pistol
AP	Armour-piercing
APCR	Armour-piercing composite, rigid
APDS	Armour-piercing discarding sabot
APHC	Armour-piercing hard core
APT	Armour-piercing tracer*
API	Armour-piercing incendiary
API-T	Armour-piercing incendiary tracer
API-DT	Armour-piercing incendiary dim tracer
ASM	Anti-structure munitions
ATGM	Anti-tank guided missile
AXO	Abandoned explosive ordnance
B	Belted (when used as suffix in cartridge calibre designation)
B-32	Broneboynozazhigatelnyy ('armour-piercing incendiary')
BMG	Browning machine gun
BZT	Broneboyno Zazhigatelno Trassiruyushchiy ('armour-piercing incendiary tracer')*
CCS	Copper-clad steel
CHS	Cartridge headspace
EOD	Explosive ordnance disposal
ERW	Explosive remnants of war
FMJ	Full metal jacket
FN Herstal	Fabrique Nationale de Herstal ('National Factory, Herstal')
GMCS	Gilding metal-clad steel

HE	High-explosive
HE-FRAG	High-explosive fragmentation
HEAB	High-explosive airburst
HEAT	High-explosive anti-tank
HEAT-T	High-explosive anti-tank tracer*
HEDP	High-explosive dual-purpose
HEI	High-explosive incendiary
HP	Hollow-point
IED	Improvised explosive device
JHP	Jacketed hollow-point
JSP	Jacketed soft-point
MDZ	Mnogovenного Deystviya Zazhigatelnyy ('instantaneous incendiary'; HEI)
MP	Multipurpose (ammunition)
OTM	Open-tipped match
PPHE	Programmable pre-fragmented high-explosive
R	Rimmed (when used as suffix in cartridge calibre designation)
RAP	Rocket-assisted projectile
RCA	Riot control agent
SAA	Small arms ammunition
SAPHE	Semi-armour-piercing high-explosive
SAPHEI	Semi-armour-piercing high-explosive incendiary
SAPHEI-T	Semi-armour-piercing incendiary tracer*
SCHV	Small-calibre, high-velocity
SR	Semi-rimmed (when used as suffix in cartridge calibre designation)
TOW	Tube-launched, optically-tracked, wire-guided
TP	Training/practice (ammunition)
TPT	Training/practice-tracer
UXO	Unexploded ordnance

Other abbreviations and acronyms

ARES	Armament Research Services
ATO	Ammunition technical officer
ATT	Arms Trade Treaty
CBP	Customs and Border Protection
dB	Decibel
DRC	Democratic Republic of the Congo
GPS	Global Positioning System
HS	Harmonized system
HTS	Harmonized Tariff Schedule
IMP	Information, materiel, and persons
ITI	International Instrument to Enable States to Identify and Trace, in a Timely and Reliable Manner, Illicit Small Arms and Light Weapons ('International Tracing Instrument')
IR	Infrared
KNP	Kruger National Park
IATG	International Ammunition Technical Guidelines*
ISACS	International Small Arms Control Standards*
LAPD	Los Angeles Police Department
NATO	North Atlantic Treaty Organization
NGO	Non-governmental organization
PID	Positive identification
PoA	Programme of Action to Prevent, Combat and Eradicate the Illicit Trade in Small Arms and Light Weapons in All Its Aspects ('Programme of Action')
PSSM	Physical security and stockpile management*
RF	Radio frequency
SDG	Sustainable Development Goal
SE	Site exploitation
SIPRI	Stockholm International Peace Research Institute
SSE	Sensitive site exploitation
TSE	Tactical site exploitation
UID	Unique identification (or unique identifier)
UN	United Nations

UN Comtrade	United Nations Commodity Trade Statistics Database
UNGA	United Nations General Assembly
UNROCA	United Nations Register of Conventional Arms
UNSD	United Nations Statistics Division
USD	United States dollar

* These abbreviations and acronyms are not used in this Handbook. They have been included here for informative and educational purposes.

CHAPTER 1

Small Arms Identification: An Introduction

Introduction

Arms and ammunition are evidence. Many weapons carry marks that, combined with their physical characteristics, reveal important information about them, including their manufacturer, age, and origin. This information, in turn, provides vital clues about the sources and flows of weapons in the area in which they were found.

Why is it important to accurately identify weapons and track arms flows? The illicit acquisition and use of small arms, light weapons, and their ammunition fuels conflict and, in post-conflict situations, allows ex-combatants to rearm for war or engage in criminal activity. Outside of conflict zones, illicit small arms enable violence and crimes, ranging from domestic violence to wildlife poaching and drug trafficking. While the type and level of violence committed with small arms and light weapons varies, no region of the world is entirely immune. The accurate identification of the types and sources of weapons used by criminals and combatants provides important insights into the dynamics and underlying causes of conflict and crime.

Knowledge of arms and ammunition also protects the reputation of journalists by preventing errors that reduce the credibility of their articles, and distract from their main message. For reporters who are working in the field, accurate identification of weapons and ammunition can be a matter of life and death: the improper handling of these items can lead to serious injury or worse.

Policy-makers and legislators also benefit from understanding how arms and ammunition function and are employed. Crafting and implementing effective policies for combatting terrorism, reducing crime, and preventing conflict require a nuanced understanding of weapons and their role in these and other societal problems. The ability to precisely and credibly discuss arms and ammunition also increases the credibility of policy-makers and the persuasiveness of their policy proposals.

The goal of this Handbook is to provide the reader with a basic understanding of how to identify and analyse small arms and light weapons, and to track their proliferation. The process of identifying arms is complex, and no single guide can provide all of the information required to identify every weapon or round of ammunition that may be encountered at crime scenes or in conflict zones. Instead, this guide explains the process by which weapons and ammunition are identi-

fied and arms flows are tracked. Reference material on specific small arms, light weapons, and ammunition is included throughout the guide. This material will help readers to take the steps necessary to identify the make and model of the most commonly encountered weapons and ammunition.

This chapter begins with a brief overview of key terms and definitions, including terms that are often used incorrectly. The chapter then presents and explains a system for classifying weapons and ammunition. The chapter concludes with an overview of the processes through which arms are identified and arms flows are mapped. Of particular importance is Table 1.3, which lists the tools and techniques for identifying and tracking weapons, and where to find descriptions of them in the Handbook.

Terms and definitions

The precise and consistent use of terminology is essential to the accurate identification and analysis of arms and ammunition. This applies not only to text but also to the use of images, video, and audio communications. The latter medium is especially imprecise and prone to error; it is possible for the listener to form a confident picture of the object being described, only to discover (when presented with an image) that it is something else entirely. The use of correct and consistent descriptors can mitigate this problem, and help ensure all correspondents are on the same proverbial page in subsequent discussions. It also allows for precise, concise, and meaningful reporting, which is as important in articles intended for lay readers as it is in publications for technical specialists.

Despite the many benefits of precise and accurate terminology, the erroneous use of terms related to weapons and ammunition is common. Some errors are so frequent that they have become colloquially ‘correct’ by virtue of popular usage. However, they remain technically incorrect and should be avoided. These errors include the misuse of terms such as ‘AK-47’, ‘assault weapon’, ‘clip’, and ‘rocket-propelled grenade’ (see Boxes 3.1, 3.2, 3.4, 5.2), ‘high-powered’ (a wholly relative term), and ‘dum dum bullet’. Often, the term ‘semi-automatic’ is incorrectly used as a synonym for ‘automatic’. Similarly, many people use the term ‘bullet’ when referring to a cartridge. There are also several terms whose specific legal definitions are very different from popular usage. A good example is the US government’s

definition of ‘machine gun’, which includes all automatic weapons, even automatic pistols and shotguns, along with key components for these weapons.¹

Government publications, technical manuals, national legislation, and multi-lateral instruments define ‘small arms and light weapons’ in various ways. The development of definitions in these different contexts, for different purposes, means that there is often inconsistency between them. In part to address this issue, some internationally-agreed definitions of ‘small arms and light weapons’ have been developed. Within the framework of the UN small arms process, the International Tracing Instrument (ITI) provides an authoritative definition of the term, applicable to all UN member states:

For the purposes of this instrument, ‘small arms and light weapons’ will mean any man-portable lethal weapon that expels or launches, is designed to expel or launch, or may be readily converted to expel or launch a shot, bullet or projectile by the action of an explosive, excluding antique small arms and light weapons or their replicas. Antique small arms and light weapons and their replicas will be defined in accordance with domestic law. In no case will antique small arms and light weapons include those manufactured after 1899:

- (a) ‘Small arms’ are, broadly speaking, weapons designed for individual use. They include, inter alia, revolvers and self-loading pistols, rifles and carbines, sub-machine guns, assault rifles, and light machine guns;
- (b) ‘Light weapons’ are, broadly speaking, weapons designed for use by two or three persons serving as a crew, although some may be carried and used by a single person. They include, inter alia, heavy machine guns, hand-held under-barrel and mounted grenade launchers, portable anti-aircraft guns, portable anti-tank guns, recoilless rifles, portable launchers of anti-tank missile and rocket systems, portable launchers of anti-aircraft missile systems, and mortars of a calibre of less than 100 millimetres. (UNGA, 2005, para. 4)

For its more technical definitions, in particular those for specific small arm and light weapon types, this Handbook relies on definitions developed by Armament Research Services (ARES).²

1 See GPO (n.d., para. 5845(b)).

2 See ARES (2017) and ARES (forthcoming).

For the purposes of this Handbook, a ‘small arm’ is defined as a firearm of less than 20 mm in calibre that, with its ammunition, may be transported and operated by a single individual on foot (ARES, 2017).

The calibre limit of 20 mm is a useful cut-off for ‘small arms’ since it includes most modern firearms. It includes, for example, firearms that are chambered for common 12.7 mm rifle cartridges, as well as common 12 gauge (18.5 mm) and 10 gauge (19.7 mm) shotgun calibres. While there are some historical and contemporary examples of rifles and shotguns chambered for calibres larger than 20 mm, their numbers are limited and they are unlikely to be encountered in the field.³ The Handbook also covers some types of small arms not listed in sub-paragraph 4 (a) of the ITI definition, such as shotguns.

For the purposes of this Handbook, a ‘light weapon’ is defined as a lethal weapon or weapons system which may be transported (with its ammunition and any essential components) and operated by a crew of as many as five individuals on foot.⁴ The Handbook also limits light weapons to systems weighing 300 kg or less when in firing configuration (not including ammunition weight) (ARES, 2017).

Unlike the category of ‘small arms’, which consists entirely of firearms, the term ‘light weapons’ covers a variety of weapon systems employing different operating principles. Definitions for these weapons are typically based on the calibre, diameter, or length of the relevant system—or its ammunition (ARES, 2017). It is also important to note that improvised and craft-produced light weapons sometimes differ significantly from their industrially-produced equivalents (Hays and Jenzen-Jones, 2018). The definitions provided above nevertheless attempt to account for such differences, when possible.

3 These include large-bore rifles used to hunt dangerous game, particularly in the late 19th century, such as 4-bore (26.7 mm) and even 2-bore (33.7 mm) designs (Brander, 1988). While largely obsolete, limited numbers of modern guns are produced in these calibres. See, for example, Schroeder and Hetzendorfer (n.d.).

4 While there is no readily-accepted understanding of *how much* ammunition must be carried, it is understood that even a light combat load for some weapon systems will constitute a substantial burden in terms of volume and weight. At a minimum, this figure should include a full weapon load of ammunition (for example, an entire magazine, complement of rockets, etc.) and, in the case of weapons typically reloaded under combat conditions, one full reload of the same number of rounds. ‘Essential components’ means those components that are required for the weapon to function.

Classifying and identifying arms and ammunition

Accurate classification and identification of arms and ammunition is the cornerstone of researching and reporting on illicit small arms and light weapons. Individual items of interest are identified on the basis of their physical characteristics—such as barrel length—and the markings present on the item. The amount and type of available information and the skill level of the researcher will determine the detail and accuracy of a classification or identification.

The ARES Arms & Munitions Classification System (ARCS) allows for the classification of arms and ammunition at various levels, as described below and outlined in Figure 1.1 (ARES, forthcoming).⁵ Some researchers may have as their primary goal the *classification* of arms and ammunition: that is, determining the class, group or subgroup, and type of the item in question. Other research requires the precise *identification* of the item: that is, positively determining, at a minimum, the item's make and/or its model. It is important to note that the identification process does not necessarily proceed according to the hierarchy of classification. It is not always necessary to know the operating system, for example, to identify a weapon's manufacturer or model. Sometimes the fastest way to identify a weapon is by looking at distinctive features or markings, such as markings that denote the make and model (which are sometimes very clear). Once the make and model are confirmed, the weapon's group, type, and other information are often easily identified.

The identification process for a practitioner with access to the weapon in question—or detailed photographs—would assess the physical features and markings on the item and may proceed as follows:

1. Determine the class.
2. Determine the make and model (and variant, if applicable) if possible.
3. Determine the type if make and model cannot be determined.
4. Determine the group if type cannot be determined.
5. Continue to refine as necessary until the make and model is identified (or the item has been uniquely identified) or no further progress is possible.

5 The definitions used in ARCS were developed by an ARES team consisting of Jonathan Ferguson, N.R. Jenzen-Jones, Ian McCollum, and Anthony G. Williams, and were reviewed by numerous external specialists.

Figure 1.1 The different levels of ARCS classification fidelity

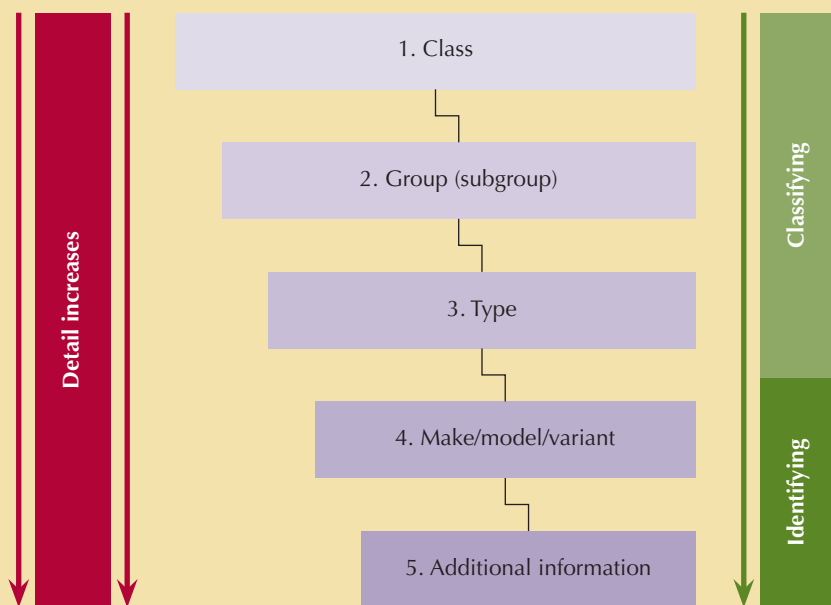

Source: ARES (forthcoming)

Figure 1.2 provides a sample description of a weapon following the ARCS methodology.

Level 1: Class

Conventional arms are typically divided into three classes: small arms, light weapons, and heavy weapons. The first two classes are the focus of this guide. Munitions (including ammunition for small arms and light weapons) are often classified based on the domain from which they are employed: land, air, and sea or subsea.⁶ Distinctions at this level for ammunition are less useful than for arms, with the primary distinctions for small arms and light weapons ammunition occurring at the group level (ARES, forthcoming).

6 In the context of this Handbook, the term ‘munition’ is used in the US military sense to mean ‘a complete device charged with explosives; propellants; pyrotechnics; initiating composition; or chemical, biological, radiological, or nuclear material for use in operations including demolitions’ and includes all small arms and light weapons ammunition (US DoD, 2018, p.158).

Figure 1.2 Description of a weapon using ARCS

Class	Small arms
Group	Long guns (self-loading rifles)
Type	Self-loading (automatic) [short-stroke gas-operated piston]
Make/Manufacturer	FN Herstal
Model	SCAR-L
Variant	CQC
Calibre	5.56 × 45 mm
Additional Information	
Year of manufacture	2004
Serial number	L014466
Country of manufacture	Belgium
PID (positive identification by make and model)	Belgian FN Herstal SCAR-L CQC 5.56 × 45 mm self-loading rifle
UID (unique identifier)	L014466 (serial number)

Image source: N.R. Jenzen-Jones/ARES

Table 1.1 Common small arms groups and subgroups

Hand guns						
Rifled				Smooth-bore		
Self-loading pistols		Revolvers		Other manually-operated handguns		Smooth-bore handguns

Long guns						
Rifled				Smooth-bore		
Sub-machine guns	Machine guns	Self-loading rifles	Manually-operated rifles	Self-loading shotguns	Manually-operated shotguns	Other smooth-bore long guns

Source: ARES (forthcoming)

Level 2: Group

Within each class, arms are separated into broad groups. Categorization by group is often possible through a simple visual examination of the item’s physical characteristics. To aid in the identification and classification process, small arms are first grouped into ‘long guns’ and ‘hand guns’. For small arms, another key distinction at the group level is whether the weapon is rifled. Researchers often correctly assume the weapon is rifled during this step, as most modern firearms are rifles and most unrifled (‘smooth-bore’) firearms in circulation are distinctive (ARES, forthcoming). Weapons may also be classified into smaller subgroups. Classification at the subgroup level includes an assessment of the general type of operating system of a weapon, but not the specific mechanical action, which is relevant at the next level (see Table 1.1). A close inspection of smaller physical details and markings is usually not necessary at this level. The equivalent grouping for light weapons is their separation into ‘hand-held’ and ‘crew-served’ weapons.

Munitions are also divided into broad groups based upon general physical and mechanical characteristics (see Table 1.2). According to this system, almost all small arms ammunition—that is, projectile ammunition of less than 20 mm in calibre—is classified in the same subgroup: ‘small-calibre ammunition’, under the ‘projectiles’ group.⁷ Light weapons, using a variety of operating systems and

⁷ The exceptions to this are very few, and consist mostly of novel designs such as miniature rockets. These types are almost never encountered in the field.

Table 1.2 Common munitions groups and subgroups (land)

Projectiles			Powered munitions			Thrown munitions	
Ammunition (calibre)		Other	Rockets	Guided missiles	Other	Hand grenades	Other
Small	Medium						
Emplaced munitions				Submunitions			
Landmines		Improvised explosive devices	Other		Unpowered (free-fall)		Powered

Source: ARES (forthcoming)

ammunition types, are somewhat more complicated, but all light weapons ammunition will fall under the ‘projectiles’ and ‘powered munitions’ groups shown in Table 1.2.⁸ Most cartridge-based ammunition for light weapons will be classified under the ‘medium-calibre cartridges’ subgroup (at least 20 mm, but less than 57 mm in diameter) or the ‘large-calibre ammunition’ subgroup (57 mm or greater in calibre) (ARES, 2017; forthcoming). Light cannon and grenade launchers, for example, generally use medium-calibre ammunition, while recoilless weapons and mortars generally use large-calibre ammunition. Guided missiles and rockets of any size have their own subgroups, under the ‘powered munitions’ group. The groups ‘thrown munitions’, ‘emplaced munitions’, and ‘submunitions’ are not relevant to small arms or light weapons, but are shown in Table 1.2 for context (ARES, forthcoming).

Level 3: Type

The third level of classification for small arms and light weapons is based on the weapon’s operating system. The operating system, or ‘action’, of a weapon describes how it performs its firing functions. Operating systems, which may be implicitly or explicitly given at the subgroup level,⁹ are refined and formalized at

8 There are a small number of light weapons capable of firing ammunition which contains submunitions. Submunitions are classified separately to the ‘parent’ munition(s) under ARCS (ARES, forthcoming).

9 An example of an implicitly given operating system is ‘machine guns’, as these weapons, by definition, make use of an automatic, self-loading action. The subgroup name may at other times explicitly include an operating system descriptor, for example ‘self-loading rifles’.

the type level into both generalized categories (for example, ‘manually-operated’, ‘self-loading’) and more specific subtypes (‘bolt-action’, ‘automatic’), as well as mechanical action descriptors (‘blowback’, ‘long-stroke gas-operated piston’).

Ammunition is distinguished by functional type—that is, a short description of the effect and often, by extension, the intended role of a given item (for example, ‘high-explosive fragmentation’ or ‘armour-piercing’). Functional types may also be categorized according to broad meta-types (for example, ‘anti-armour’) and narrower subtypes (for example, ‘armour-piercing fin-stabilized discarding sabot’).

Level 4: Make, manufacturer, model, and variant

Determining the model of an item is perhaps the most common goal for those engaged in the identification of small arms and light weapons. An item’s model is sometimes described in general terms (for example, ‘an AK-type self-loading rifle’, denoting weapons using an Avtomat Kalashnikova-type operating mechanism and general configuration), or in more specific terms (‘AKM-pattern self-loading rifle’, which may apply to weapons that are close copies of a specific model, the Avtomat Kalashnikova Modernizirovanny). Ideally, researchers will determine the precise model of the weapon; to do so they need to identify the weapon’s make (‘IZHMASH AKM self-loading rifle’). A simple way to conceive of a weapon’s ‘make’ is to think of it like a brand. It is often marked on a weapon.¹⁰ When make (and/or manufacturer) and model are known, the researcher will have achieved a positive identification of the item. Once they have a positive identification, they will also know the calibre.¹¹

The identification of a particular model may be further narrowed by the identification of a variant, if applicable. For example, the AK-103 self-loading rifle that will be discussed in Chapter 7 was identified as an AK-103-2 variant based on the weapon’s action and specific markings on the firearm (Jenzen-Jones, 2016c).

10 The make is distinct from the manufacturer, in that some manufacturers may produce more than one brand of weapon at the same factory. Other makes of weapons will be produced in different factories, despite sharing a ‘brand’ (ARES, forthcoming). See Chapter 3 for more details.

11 While some manufacturers may consider weapons of the same model in different calibres to be ‘variants’, ARCS considers calibre to be integral to the model of the weapon. Some weapons may be multi-calibre types (for example, modular weapons; see Ferguson, Jenzen-Jones and McColium (2014); Persi Paoli (2015)), but should generally be documented in the configuration in which they are recovered or observed (ARES, forthcoming).

Level 5: Additional information

Some types of investigations demand additional information. For example, tracing operations frequently require the unique identifying mark on a particular item.¹² This mark may be unique to a particular item (such as a serial number), or to a group of items (for example, a ‘lot’ or ‘batch’ number). Unique identification (UID) has been achieved once a researcher has correctly identified and recorded such markings. Other data, such as explosive fill, fuse type, year or date of production, is also often useful. Researchers sometimes gather even more detailed data, including forensic evidence, in the course of investigations.

Identifying weapons and analysing arms flows: an overview

This section provides a step-by-step overview of the processes by which weapons are identified and arms flows are tracked. The process consists of two distinct but interconnected tasks: identifying individual weapons and tracking their movement through the transfer chain.

Identifying the make, model, and variant of weapons and ammunition

The first step in the classification and identification process, which is summarized in Figure 1.1, is to determine whether the item in question is a small arm, light weapon, or related item (component, accessory, or ammunition). This Handbook contains detailed descriptions of small arms (Chapter 3), light weapons (Chapter 5), and their ammunition (Chapters 4 and 5), and includes numerous photographs of each class of items. These chapters also identify and describe some of the components of—and major accessories for—small arms and light weapons. Chapter 6 discusses improvised weapons, which are often very different—in form and function—from their factory-produced counterparts.

The next step is to identify the group of small arms, light weapons, or ammunition to which the item belongs. Grouping light weapons is sometimes easier than small arms because light weapons are more distinctive in appearance. Chapter 5 provides detailed descriptions of the main subcategories of light weapons and includes several photographs of weapons from each category. Chapters 4 and 5 provide similar descriptions of ammunition for small arms and light weapons respectively.

¹² This may be unique to a particular item, or to a group (most commonly a ‘lot’ or ‘batch’) of items.

Box 1.1 Developing arms and ammunition baseline assessments

Research on arms and ammunition, regardless of the context in which it is applied, frequently benefits from identifying the types of weapons in use (whether legally or illegally) in a given location, along with the time period or context in which the weapons are acquired and used. The resulting ‘baseline’ is useful for detecting the appearance of new makes or models of weapons in a given region, or the influx of large numbers of weapon types or models already present in the region. Analysis of this kind often provides the basis for more detailed investigations, including tracing operations (see Box 1.2). In Syria in 2012, for example, the sudden appearance of distinctive Swiss-made hand grenades not known to be present in the country suggested the possible diversion of these items from a legitimate state-to-state export. An examination of the grenades’ markings by specialists resulted in the identification of several items from the same lot, and inquiries directed to relevant states confirmed that the items were diverted from an authorized export to a regional government (ARES, 2016c).¹³ These weapons stood out against the other hand grenades common in the region; additional examples of the diversion of the same models were later documented in Libya and Turkey.

Baseline assessments can often be accurately produced through desk-based research. Useful sources of information include images and data on the markings, packaging, and shipping documents of arms and ammunition in the region in question, along with the various reports, databases, and notifications examined in Chapters 8 and 9. Fieldwork is an important supplement to these data sources and may be the only source of data in some cases. Nonetheless, fieldwork is most useful when supplemented by data drawn from other sources. Fieldwork takes many forms, which range from taking a photo of a fired cartridge case encountered during unrelated research to compiling detailed inventories of arms captured from rebel groups on the frontlines. More information on fieldwork is available in Chapter 7.

The final step is to identify the make, model, and variant of the item. This is often the most difficult part of the identification process and usually requires a careful analysis of the physical features of the item and the markings on key components. Available imagery is often too blurry or off-centre to read the markings on weapons and ammunition, precluding the use of markings as a tool for identifying the items. Even in these cases, however, it is often possible to identify the weapon by carefully inspecting key physical characteristics, reviewing data on arms transfers to and within the region where the item was encountered, and interviewing individuals with first-hand knowledge of regional arms flows. Use of these analytical techniques is illustrated and explained in the case study in Chapter 7.

This Handbook provides a thorough overview of how to analyse the physical characteristics of, and markings on, weapons and ammunition, but it does not—and cannot—provide all of the information required to definitively identify each of the many thousands of different makes and models of small arms, light weapons, and ammunition in circulation today. No such compilation of information exists and, even if it did, it would be too voluminous to include in a Handbook

¹³ See also Holtom, Pavesi, and Rigual (2014, p. 119).

Box 1.2 Arms tracing

With enough information, government authorities and some specialized organizations can trace arms and ammunition to the last known authorized end user. Tracing operations often provide insights into an item's ownership history, including, at times, the point at which it was diverted into the illicit sphere. Tracing operations usually involve 'tracing requests', which are issued to authorities, organizations, or individuals who may hold relevant data regarding the item in question. Ammunition is also traced but generally not with the same precision as a weapon, since individual cartridges are typically marked with a batch or lot number rather than a unique serial number. Arms tracing is enabled by the accurate identification of arms or ammunition. It is, conversely, hindered or rendered impossible by the inaccurate identification of these items.

of this type. There are numerous reference guides from a variety of sources, some of which are freely available. It should be noted that even the best reference materials contain errors and thus information from these and other guides should be corroborated with other sources whenever possible. As a rule, researchers should first seek out information from manufacturers and original users (such as armed forces) of the items in question, followed by authoritative publications that cite these primary sources.

Mapping the chain of custody

Identifying the sources and trafficking patterns of illicit weapons often requires more than just an analysis of the physical characteristics of the weapons and their markings. Mapping arms flows requires careful analysis of other data sources, including reports on international arms transfers, baseline assessments of arms within a given country (see Box 1.1), shipping documents, and the packaging in which weapons are stored and shipped. These sources often contain important clues regarding the chain of custody of small arms and light weapons, and the point at which weapons are diverted to terrorists, criminals, and insurgents.

As defined in Chapter 2, the chain of custody (or 'transfer chain') is the series of transfers and retransfers that starts with the manufacturer and concludes with the delivery of the transferred item to its current owner or operator, or 'end user'. The chain of custody can be relatively short—the current end user receives the item directly from the manufacturer—or it can be long and circuitous, and may involve theft, loss, or diversion. Chapter 2 provides a more in-depth explanation of chains of custody and the many different types of transfers they comprise.

Mapping chains of custody is usually less straightforward than identifying the make, model and variant of a weapon. Often, the point in the transfer chain at

Figure 1.3 Selected markings on a Heckler & Koch HK417 self-loading rifle



1	Make/manufacturer	Heckler & Koch (HK) logo
2	Model name	HK417
3	Calibre	Cal. 7.62 mm x 51
4	Serial number (lower receiver)	89-001914
5	Serial number (upper receiver)	89-001914
6	Quality control and proof marks	HK quality control mark, German national proof mark (letter 'N'), German year of proof code, Ulm proof house proof mark
7	Fire selector markings	Pictographic markings
Positive identification		Heckler & Koch HK417 self-loading rifle

Image source: N.R. Jenzen-Jones/ARES

which one starts the mapping process depends on the information at hand. For example, if the only available data source is the markings on the weapon in question and the most recent end user is unknown, the most logical place to start mapping the weapon's chain of custody would be the country of origin (unless the markings identify the importer). In other cases, the end user may be known but not the country of origin (because the markings on the weapon in question are not visible). In that case, the researcher would start their investigation at the other end of the transfer chain, that is, with the most recent end user.

Many of the sources of data on the transfer chain are the same sources used in the weapons identification process. Markings on weapons and ammunition often identify the country of origin or manufacturer, the date of manufacture, and, in some cases, importers or importing countries.¹⁴ Similarly, distinctive physical characteristics of weapons and ammunition sometimes provide clues regarding the date or country of manufacture. Techniques for analysing and interpreting these clues are provided in Chapters 3, 4, and 5.

Figure 1.3 shows a readily identifiable weapon, marked with clear and well-known make and model markings. However, even if those particular marks were obscured or removed, the other markings on the weapon would provide valuable information. The calibre marking would help researchers to narrow down the possible models, for example, and the pictographic fire selector (with symbols for safe, semi-automatic, and automatic functions) would aid in this process. But there is other, less obvious, information to be gleaned from the markings. The two-digit serial number prefix '89' indicates the model of the weapon under HK's marking scheme; the letters 'AK' alongside the proof marks indicate the weapon was proofed (and likely manufactured) in 2009; and the 'antler' proof mark indicates the weapon underwent proof testing at the Ulm proof house (Beschussamt Ulm), where German-made HK weapons are proofed.

The documentation accompanying arms shipments and the packaging in which these items are shipped also contain valuable information about exporters, importers, export dates, and the quantity of weapons shipped. Examples of documentation and packaging for weapons and ammunition—and a sample of the insights that these materials provide—are included throughout the Handbook.

Official and unofficial data on international arms transfers is another rich source of information on arms flows. Governments and international organizations have

¹⁴ Less commonly, exporters or exporting countries.

Table 1.3 Using this Handbook to identify arms and track arms flows

Identifying the weapon

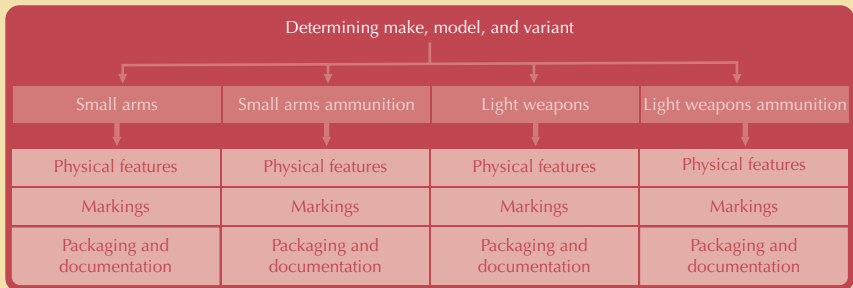
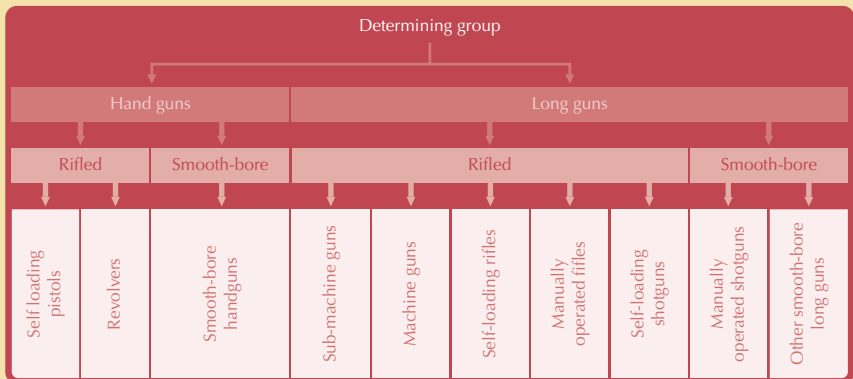
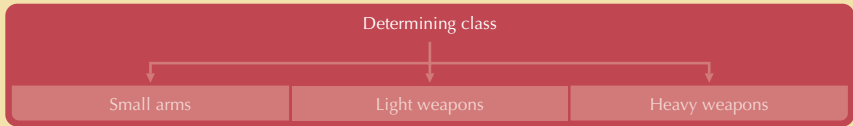

Mapping the chain of custody

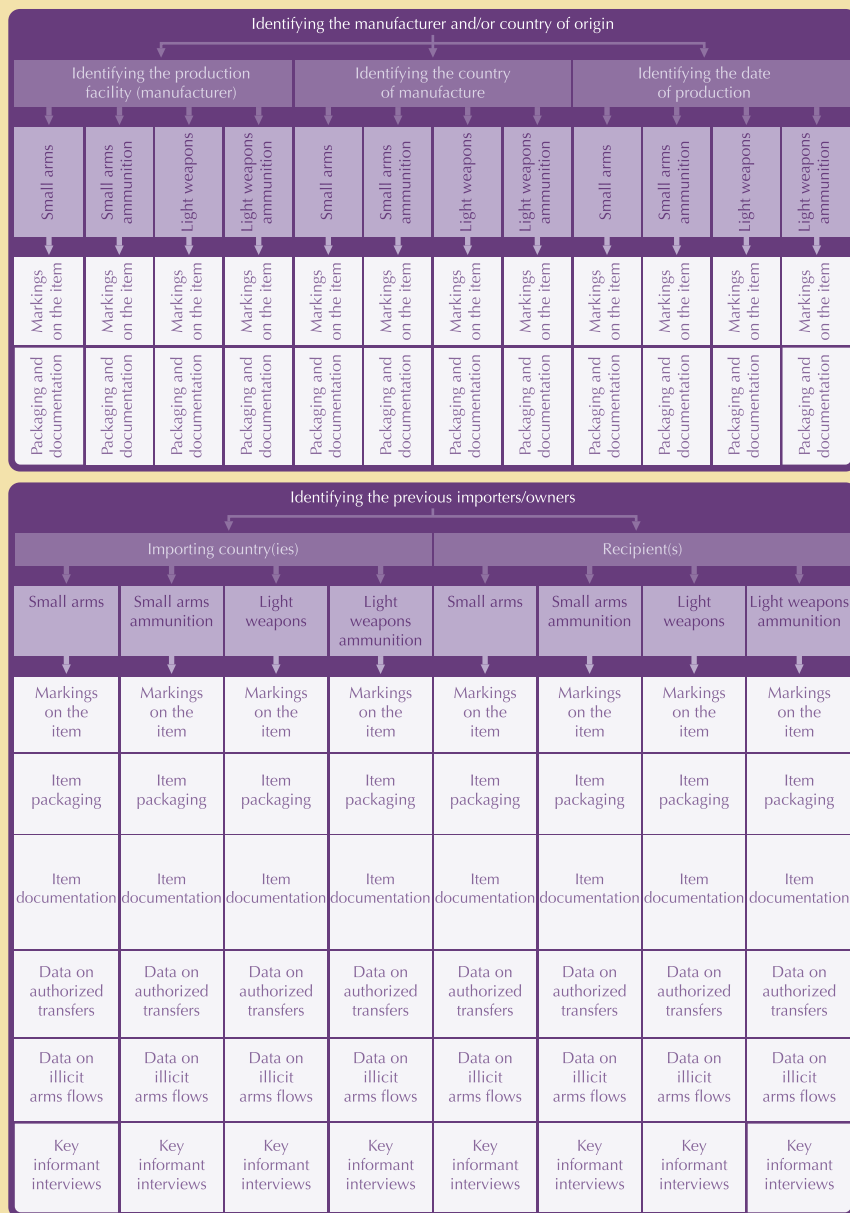

published thousands of records on imports and exports of small arms and light weapons. The specificity and completeness of these records vary, but many contain important information about the sources and recipients of exported weapons and, to a lesser extent, ammunition. Social media is an increasingly important (primarily unofficial) source of information on arms flows. Using social media to systematically map chains of custody is difficult, but it is often a valuable supplement to official reporting. Chapter 8 provides a thorough overview of these data sources, their strengths and limitations, and strategies for analysing and interpreting them.

Mapping the transfer chain after a weapon is diverted to an illicit user is often significantly more challenging than tracking the item's movement through authorized channels (which itself is no small feat). Data on illicit arms flows includes court documents, declassified intelligence reports, media articles, and reports from research organizations such as the Small Arms Survey and ARES. Data on seized weapons is also used to study illicit arms flows.¹⁵ Individual summaries of weapons seizures rarely reveal the sources or trafficking routes of illicit weapons but, when aggregated and combined with other data sources, they can shed light on the type and quantities of illicit weapons, and changes in illicit arms flows over time. Chapter 9 identifies key sources of data on illicit weapons and explains how to analyse them.

Table 1.3 shows the processes through which arms are identified and arms flows are tracked. It is important to note that not all of the details listed in the table are required for every type of analysis, and key details are often not available at all. At the same time, all information is potentially relevant, and seemingly unrelated data can be used to fill information gaps. These and other analytical strategies, tips, and techniques are explained in greater detail in the rest of the Handbook.

— **Authors: N.R. Jenzen-Jones and Matt Schroeder**

¹⁵ See, for example, Schroeder (2013a; 2014b) and Schroeder and King (2012).

CHAPTER 2

Understanding the Trade in Small Arms: Key Concepts

Introduction

The trade in small arms, light weapons, and their parts, accessories, and ammunition involves every country in the world.¹⁶ It includes transfers that are authorized by states and illicit flows of arms that violate national or international law. This chapter provides readers with the background knowledge and key concepts required to understand both aspects of the trade, and the linkages between them.

The authorized trade

The authorized trade in small arms is diverse and dynamic. It includes both new and surplus arms, and affects every geographical region, and every level of society. Military and law-enforcement agencies worldwide buy millions of imported weapons each year. In addition, hunters, recreational shooters, and other individuals privately buy millions of firearms and hundreds of millions of rounds of ammunition. In 2012, the Small Arms Survey estimated the annual value of international small arms transfers at more than USD 8.5 billion (Grzybowski, Marsh, and Schroeder, 2012, p. 241). More recent data suggests that the value of this trade has increased significantly since then (Pavesi, 2016, p. 14).

Despite its size, the authorized international trade in small arms and light weapons remains to a large extent opaque. Only a fraction of the trade is represented in publicly available data, and much of that data is incomplete or vague. Every year, thousands of small arms and light weapons transfers are therefore either inadequately documented or not documented at all, making it difficult to monitor arms transfers to problematic recipients or to identify the accumulation of excessively large weapons stockpiles (Grzybowski, Marsh, and Schroeder, 2012, p. 241).

Types of transfers

Authorized small arms transfers take many forms. From shipments of thousands of weapons purchased by foreign governments to individual rifles packed in the checked luggage of participants in international shooting competitions, these

16 The term 'small arms' is used in this chapter to refer to small arms, light weapons, and their ammunition (as in 'the small arms industry') unless the context indicates otherwise, whereas the terms 'light weapons' and 'ammunition' refer specifically to those items.

transfers are much more diverse than commonly assumed. The Small Arms Survey has identified the following types of transfers, which can be grouped into three main categories:

- **Sales** are the most common type of transfer and consist of exchanges of weapons for money or other commodities.¹⁷ Sales can be further divided into commercial exports and government-to-government exports.¹⁸
- **Exports of weapons to governments** as part of foreign aid programmes or for use in military training exercises are a second important category of transfers. Arms and ammunition exported as part of foreign aid programmes are often provided at little or no charge. Weapons used in foreign military training exercises are sometimes given to the host country after the exercise.
- **Other categories** of authorized transfers include:
 - shipping weapons from troop-contributing countries to their peacekeeping forces deployed abroad;
 - sending weapons abroad for repair, demilitarization, or at the end of a lease;
 - transporting surplus or obsolete weapons to a foreign country for disposal;
 - temporarily exporting firearms for sporting and hunting purposes.

The transfer chain

Common to all categories of imports and exports is the transfer chain, a series of transfers and retransfers of small arms that starts with the manufacturer and concludes with the delivery of the transferred item to its new owner or operator, often referred to as an ‘end user’. The first link in this chain is the transfer of a newly-produced weapon from the manufacturer to the original recipient. This transfer can be private, commercial, or governmental, and can be foreign or domestic. Any subsequent change of ownership is referred to as a retransfer. Retransfers to international recipients are often referred to as re-exports (if there is a change in ownership), while retransfers to entities in the same country are ‘domestic retransfers’.

The transfer chain is often long and circuitous, with exported weapons being transferred and retransferred to several end users over the course of years or decades. Figure 2.1 shows a hypothetical transfer chain.

17 Manufacturers also often ship small quantities of sample weapons to potential buyers as part of marketing efforts. See Dreyfus, Marsh, and Schroeder (2009, p. 9).

18 For more information, see Dreyfus, Marsh, and Schroeder (2009, p. 9, Box 1.1).

Figure 2.1 Example of an arms transfer chain

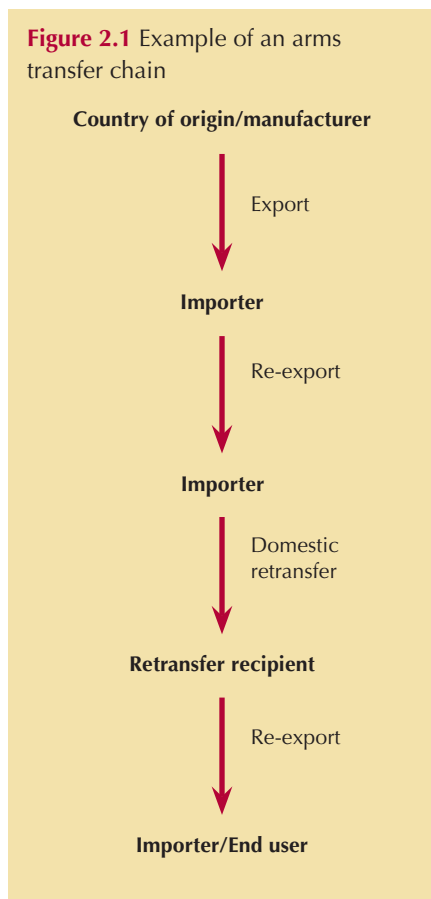

Authorized but illicit

Most authorized transfers are made in accordance with national and international laws. Yet some transfers may be permitted by the government of the exporting country, but viewed as a violation of international law by other countries and actors. The UN Panel of Experts on Libya and *The New York Times*, for instance, documented transfers of arms from the United Arab Emirates (UAE) to forces in Libya between 2013 and 2015, which the UAE government organized without notifying the UN Sanctions Committee, and which therefore violated the arms embargo. The items shipped included pistols that later resurfaced in Libyan black markets (Kirkpatrick, 2015; UNSC, 2015, paras. 125–31). Such examples illustrate the grey areas that exist between the authorized and illicit trade in small arms.

The illicit trade in small arms

The illicit trade in small arms and light weapons occurs in all parts of the globe but tends to be concentrated in areas afflicted by armed conflict, violence, and organized crime, where the demand for illicit weapons is often highest. Illicit arms fuel civil wars and regional conflicts; stock the arsenals of designated terrorist organizations, drug cartels, and other armed groups; and contribute to violent crime and the proliferation of sensitive technology.

The Small Arms Survey defines illicit small arms as ‘weapons that are produced, transferred, held, or used in violation of national or international law’ (Schroeder, 2013a, p. 284). This definition acknowledges the many different forms

illicit arms flows can take (de Tessières, 2017, pp. 4–5). Three broad categories are reviewed here: the diversion of legal holdings of small arms, the illicit production of firearms, and the recirculation of existing stocks of illicit weapons.

Box 2.1 International efforts to curb illicit arms flows

The problem of illicit arms flows gained increased international attention following UN member states' adoption of the 2030 Agenda for Sustainable Development. The Agenda stresses the connection between sustainable development and 'peaceful and inclusive societies' in Sustainable Development Goal (SDG) 16, and calls for a significant reduction in illicit arms flows by 2030 in SDG Target 16.4 (UNGA, 2015). How to achieve such a reduction? Above all, by implementing the arms control instruments adopted since the late 1990s at the subregional, regional, and global levels, and given practical effect in the national laws and regulations of participating governments (McDonald, Alvazzi del Frate, and Ben Hamo Yeger, 2017).

To varying degrees, these instruments cover the small arms and light weapons life cycle from manufacture to final disposal or destruction. They aim, first and foremost, to strengthen control over legal weapons throughout their life cycle to prevent them from being diverted into the illicit market; such diversion is the primary source of illicit weapons worldwide. Instruments such as the UN Firearms Protocol (UNGA, 2001a), the UN Small Arms Programme of Action (UNGA, 2001b), and the Arms Trade Treaty (UNGA, 2013a) thus require governments to assess and reduce diversion risks before authorizing an international arms transfer, employing measures such as end-user certification and brokering controls. At the same time, instruments such as the Programme of Action address the potential diversion of weapons and ammunition from state security force stockpiles, another major source of illicit material, through stockpile management and security measures.

As this chapter notes, a small but still significant portion of the illicit weapons market derives from illicit production. For this reason, the UN Firearms Protocol and Programme of Action require states to regulate arms manufacture and criminalize unauthorized weapons production. A related type of illicit arms flow mentioned in this chapter, the recirculation within illicit markets of weapons that were already illicit, is addressed through counter-trafficking measures that include the identification and interception of illicit arms shipments at border crossings.

The multilateral arms control instruments typically recommend that seized illicit weapons be destroyed in order to prevent them being diverted back into the illicit market, as sometimes occurs. Whatever form of disposal is selected, however, seized weapons need to be uniquely marked—if they do not already possess such markings—and recorded to reduce diversion risks and detect cases of diversion when they occur.

The International Tracing Instrument (UNGA, 2005), another global arms control instrument, establishes common international rules for weapons marking, record-keeping, and international cooperation. These aim to allow law enforcement officials to follow a recovered weapon's history from the time of its manufacture (or of its last legal importation) to the point at which it was diverted into the illicit market. Law enforcement agencies can then identify and disrupt sources of illicit arms supply. A critical diagnostic tool, weapons tracing rounds out the international arms control arsenal outlined in this box, which, if effectively implemented, will allow governments to reduce illicit arms flows over time.

Author: Glenn McDonald

Diversion of legal holdings

Most illicit small arms are legally-produced weapons that are diverted to armed groups, criminals, and other unauthorized users at some point during their (often lengthy) life span. Yet the term ‘diversion’ is not clearly defined in international legal instruments. Experts generally refer to diversion not simply as the movement of arms from the legal to the illicit sphere, but rather as the unauthorized change in possession or use of these weapons (Parker, 2016, p. 118). Three main patterns of diversion are presented below.

Transfer diversion

A transfer diversion occurs when weapons are lost, stolen, or deliberately retransferred to a recipient who is not officially authorized to receive the weapons, or when the recipient violates end use agreements. As illustrated in Figure 2.2, transfer diversion can take place at most points along the transfer chain: in the country of origin (point of embarkation); en route to the intended end user (in transit); at the time of or shortly after delivery to the declared recipient (point of delivery); or some time after importation (post-delivery) (Schroeder, Close, and Stevenson, 2008, p. 115).

Figure 2.2 Points of potential diversion in a typical transfer chain

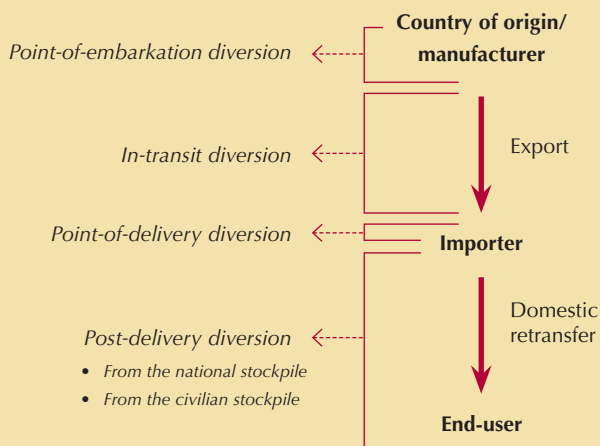

Some transfer diversions are planned and executed across several stages of the transfer chain. This is particularly true of diversions that occur in-transit or at the point of delivery. The measures necessary to divert weapons while they are in transit are often taken long before the ship or aircraft carrying the weapons leaves the port or airport of origin. Most in-transit and point-of-delivery diversions involve transportation by air or sea. Aircraft and ships that are used in major in-transit and point-of-delivery diversions are typically registered under flags of convenience, meaning they are registered in a state other than that of their owner, often in order to reduce operating costs or avoid regulations in the owner's own state. Such vessels tend to be owned by offshore shell companies that frequently change their names and shift their locations and assets from country to country (Schroeder, Close, and Stevenson, 2008, p. 115).

Another key feature of transfer diversion is the use—or misuse—of documentation. Traffickers may forge transfer documents, such as end-user certificates, bills of lading, and flight plans, to include false information about the shipment or the parties involved. Alternatively, diversion may involve corrupt government officials who sign authentic transfer documents (Schroeder, Close, and Stevenson, 2008, p. 118).

Other transfer diversion techniques that are commonly used by arms traffickers in some parts of the world include:

- falsifying shipping documents, including commodity descriptions and personal information about the shipper and recipient;
- undervaluing illicit shipments of small arms to minimize scrutiny by customs officials;
- using circuitous routing and multiple transshipment points to conceal the destination of illicit shipments bound for countries of concern;
- scratching off, or painting over, serial numbers and other identifying markings on weapons and ammunition;
- disassembling weapons, mislabelling storage containers, and concealing illicit items within or behind household goods, building materials, and machinery; and
- using shell companies and straw purchasers to hide the identities of traffickers and their links to the illicit shipment.

Diversion from the national stockpile

Arms and ammunition can also be diverted from a stockpile under the control of a state's defence and security forces (called the 'national stockpile'). Weak oversight and poor physical security measures facilitate several forms of diversion of national stockpiles, including theft by personnel and by external actors as well as battlefield loss and capture.

National stockpiles are not usually held permanently in any one place. They are often relocated from one military base to another in response to patterns of deployment, changing demand, and the need for repairs or alterations (Parker, 2016, pp. 120–21). As a result, the possible points of diversion are numerous and include storage sites, convoys transporting equipment, and security personnel carrying the weapons on duty. Diversion affects all national and security forces, including those operating abroad in the context of peace operations (see Box 2.2).

Box 2.2 Diversion of arms and ammunition in peace operations

Around 110,000 police and military personnel are currently deployed as United Nations peacekeepers (known as Blue Helmets) in 14 UN peacekeeping operations (UNDPKO, 2018). Between 2004 and 2014 there were at least 35 notable incidents of diversion or loss of weapons and ammunition during peacekeeping operations in these countries. The Small Arms Survey estimates that losses during these incidents totalled more than 750 weapons and 1.2 million rounds of ammunition (Small Arms Survey, n.d.a). These incidents, each of which involved the loss of more than ten weapons or more than 500 rounds of ammunition, have occurred during patrols, during attacks on convoys, and on fixed sites.

In the notable incidents documented in South Sudan and Sudan alone, a total of more than 500 weapons and more than 750,000 rounds of ammunition were seized. These items include handguns, self-loading rifles, machine guns, grenade launchers, anti-tank weapons, and mortars, as well as the ammunition for these weapons. A single such incident resulted in the loss of more than 500,000 rounds of ammunition. Four others probably involved losses of at least 10,000 cartridges. Very little equipment lost during these attacks has been recovered.

Accurate information is difficult to obtain, as there is imperfect reporting and record-keeping, and a noticeable reluctance to share bad news. Additionally, when weapons are recovered by peacekeepers in cordon and search operations, engagements with hostile forces, or raids on arms caches, there is rarely any systematic record-keeping. Some items are returned to the armed group from which they were taken, some are redistributed to local authorities, and others are destroyed or retained for safekeeping. The diversion of such weapons often goes unreported. Future diversions could be prevented by improved record-keeping, reporting, and oversight.

Sources: Based on Berman and Racovita (2015) and Berman, Racovita, and Schroeder (2017), with updated data from Small Arms Survey Peace Operations Data Set (PODS) (Small Arms Survey, n.d.a) and UNDPKO (2018)

The volume of diverted equipment can vary greatly depending on the type of incident. At the lower end of the spectrum is the theft of relatively minor quantities of weapons and ammunition by individuals and small groups of people. It may occur at all levels of the national stockpile, but is generally characterized by its links to localized illicit trade rather than to regional or international transfers. The problem is largely a result of local demand factors combined with poor stockpile management. It is often facilitated by the concealability and portability of small arms (Bevan, 2008, p. 47).

National stockpile diversion can also involve the theft of larger volumes of arms and ammunition, sometimes consisting of many hundreds of tonnes of weaponry. It is often facilitated by poor stockpile management practices, but in many cases it results from factors that are much broader than the management of arms and ammunition *per se*. Weak state structures, a lack of accountability within political and military administrations, and associated loopholes in transfer regulations sometimes combine to provide some highly placed individuals with the opportunity to divert weapons (Bevan, 2008, p. 56). However, in many significant cases of loss, such as Iraq in 2003 and Libya in 2011, it is primarily conflict and the ensuing collapse of state institutions that leads to mass looting of the national stockpile.

Diversion from the civilian stockpile

The 'civilian stockpile' comprises arms and ammunition acquired and held by a broad array of individuals and organizations, ranging from firearm manufacturers and wholesalers to gun shops and hunters. Diversion from any one of these locales has the potential to contribute to unlawful use, armed crime, and violence (Bevan, 2008, p. 62). In particular, the diversion of civilian-owned weapons and ammunition can be a significant source of weapons that are used in crime, including in the poaching of protected wildlife (see Box 2.3).

At one end of the spectrum are arms and ammunition that are inadequately stored in homes and vehicles. Weapons diverted from these sources often enter the illicit market as a by-product of other illegal activity, such as residential burglaries and theft from automobiles. At the other end of the spectrum are the relatively large quantities of weapons held in gun shops and wholesale warehouses, which are often attractive targets for organized crime. These cases can in some instances be a source of arms and ammunition for insurgent groups (Bevan, 2008, pp. 62–63).

Box 2.3 Firearms used in elephant and rhino poaching in Africa

Military-style firearms and relatively powerful hunting rifles are commonly used to poach elephants and rhinos in Africa (Carlson, Wright, and Dönges, 2015), and the impact of poaching on wildlife populations is considerable. Findings from a 2016 continent-wide census indicate that African elephant populations are decreasing at a rate of eight per cent, roughly 27,000 per year (Steyn, 2016). In 2015, more than 1,330 rhinos were killed by poachers—about five per cent of Africa's total rhino population—marking the sixth consecutive increase in annual rhino poaching rates (IUCN, 2016).

An investigation of rhino poaching in Southern Africa highlights the potential benefits of tracing firearms to mitigate their illicit use. In South Africa, Kruger National Park (KNP) has the highest rhino poaching rate in the world; among the weapons seized from poachers in KNP are Mauser, Winchester, and Brno brand hunting rifles. Poaching groups in KNP typically operate in small teams of five or six people, and records of poaching arrests infer that roughly 80 per cent of poachers there are Mozambican nationals (Serino, 2015). Poaching rates in KNP increased from 50 incidents in 2009 to 827 recorded rhino kills in 2014 (Poaching Facts, 2018).

Strikingly, imports of hunting rifles to Mozambique increased at nearly an identical rate over the same four-year period. United Nations Commodity Trade Statistics Database (UN Comtrade) data reveals that the Czech Republic is among the major exporters of hunting rifles to Mozambique, and that it is also the place where the CZ Brno 550 rifle—increasingly popular with Mozambican poachers—is manufactured (UNSD, n.d.c). While the implications of a direct link between Mozambican hunting rifle imports and KNP rhino kill rates would be significant, more needs to be learned of possible correlations by matching seized weapons' serial numbers with registration records in Mozambique and, potentially, with import and export records.

In some poaching areas, it is more difficult to identify and trace weapons used to kill wildlife. In Central Africa, for example, where armed groups including militias, rebel groups, and state security forces have conducted large scale elephant poaching, weapons seizures are less frequent than in places such as KNP, where poaching teams are smaller. However, an analysis of the headstamps of cartridge cases found at elephant kill sites can provide clues to which armed groups are poaching, or where they are sourcing their ammunition. Past investigations into fired cartridge cases recovered from kill sites in Cameroon, the Central African Republic, Chad, and the Democratic Republic of the Congo (DRC) have uncovered links to Sudanese government stores (Vira and Ewing, 2014), suggesting the possibility of access to common ammunition supply channels by poachers operating across a broad geographic region.

Many anti-poaching units are ill-equipped to confront the increasingly advanced firepower wielded by poachers in their pursuit of ivory and rhino horn. Unfortunately, systems to trace ammunition found at elephant kill sites often do not exist or are underutilized. When data on seized firearms is collected, it often contains little more than the total number of seized weapons, missing useful information about the types of weapons or their markings. These data gaps hinder efforts to improve understanding of supply chains and emergent patterns of poachers' weapons and ammunition usage. More and better data—such as data collected by applying the principles outlined in this Handbook—would improve anti-poaching policies and assist governments to better equip and prepare wildlife rangers and other front-line defenders to fight the scourge of poaching.

Author: Khristopher Carlson, based on Carlson, Wright, and Dönges (2015)

Illicit production of small arms

While most small arms and light weapons are legally produced, there are notable exceptions to the rule. Weapons produced by individuals or small groups, typically operating outside of state control, as well as replica and deactivated firearms that are modified to function as real firearms, represent additional sources of illicit arms flows.

Craft production¹⁹

The term ‘craft production’ refers mainly to weapons and ammunition that are fabricated primarily by hand, and in relatively small quantities. Improvised and craft-produced weapons are addressed in Chapter 6 of this Handbook. This type of production may sometimes be overseen and regulated by government authorities; an example of this is the production of high-end sporting firearms by skilled artisans. Most weaponry of this type, however, is made outside state control, or with limited oversight. These weapons may subsequently be used against government targets or in other criminal activity.

Improvised and craft-produced small arms and light weapons vary in quality from crude, improvised single-shot guns to semi-professionally manufactured copies of conventional firearms. Improvised and craft-produced weapons are made in sizeable quantities in states with significant authorized small arms manufacturing capabilities as well as in countries without significant domestic production capabilities.

The craft production of firearms has a long tradition in several parts of the world. In West Africa, for example, the practice is widespread, with blacksmiths producing a range of small arms. So-called ‘Daneguns’ (see Chapter 6), which are especially popular in Nigeria and Ghana, are based on 19th century European designs. In Pakistan, the Khyber Pakhtunkhwa province is home to numerous workshops that craft produce small arms. In Colombia, the Revolutionary Armed Forces of Colombia (FARC) have produced copies of Italian semi-automatic pistols and US sub-machine guns.

Ammunition for small arms and light weapons is also improvised and craft produced (see Chapter 6). Reloading ammunition—that is, reusing cartridge cases to

¹⁹ This section is adapted from Berman (2011) and Hays and Jenzen-Jones (2018).

produce finished cartridges—is a popular pastime for hobbyists, who are sometimes known as handloaders. Reloading is usually practised on a small scale, with the ammunition intended for personal use. Evidence suggests that reloading ammunition is conducted on a much bigger scale in parts of Pakistan and elsewhere, however, where it is often intended for retail sale.

Several armed groups have developed the capacity to make light weapons. Mortars seem to be the most commonly produced type, as they are relatively easy to produce and store, and can often be fabricated from readily available materials. The Irish Republican Army (IRA), for example, manufactured numerous mortar designs, often featuring delay or remote-control mechanisms (Oppenheimer, 2008). More sophisticated light weapons are also craft produced, including grenade launchers and recoilless weapons. Various Palestinian armed groups, for example, produce large quantities of light weapons such as single-launch rockets, while in the Philippines, the Moro Islamic Liberation Front has made copies of the Soviet RPG-2 recoilless weapon and the US M79 grenade launcher. In the Iraqi city of Mosul, non-state armed group Islamic State (IS) developed the production of mortars and rockets on an industrial scale (Conflict Armament Research, 2016, p. 7).

One of the most common craft-produced weapons is the improvised explosive device (IED). These are often made from commercially available and relatively inexpensive materials such as ammonium nitrate, acetone, hydrogen peroxide, and potassium chlorate. The charge and booster are often taken from artillery shells, mortar bombs, or other conventional ammunition. IEDs are not generally considered light weapons and are not covered in this Handbook.

Converted and 'reactivated' weapons²⁰

Firearms conversion involves modifying an imitation or deactivated firearm to fire live ammunition.²¹ Converted firearms may be based on blank-firing firearms (sometimes called 'alarm guns'), air guns, or even toy guns. Deactivated firearms—genuine firearms that have been rendered inoperable (that is, incapable of expelling a projectile)—may also be converted in a similar fashion.

The conversion changes the nature of the device so that it functions as—and meets the definition of—a real firearm. Converting a replica or deactivated firearm

20 Section authored by Benjamin King, based on King (2015) and Florquin and King (2018).

21 Converted and 'reactivated' firearms are addressed in Chapter 6 of this Handbook.

essentially involves removing the barriers to normal firearm functionality put in place by manufacturers or deactivating authorities.

Those who purchase converted firearms do so to use them for self-defence, but also for criminal purposes (Jenzen-Jones and McCollum, 2017, p. 29). Converted firearms are relatively easy to find and are affordable: even after their conversion, they can cost as little as ten per cent of the price of real pistols and revolvers (King, 2015, p. 8). Moreover, converted firearms carry the added value of being generally less traceable than real guns, as some countries do not subject readily convertible imitation and deactivated firearms to the same registration and licensing restrictions as real firearms. As a result, smugglers typically purchase readily convertible weapons legally in countries where they are sold with few restrictions, before smuggling and converting them for illicit use in locations where firearm laws are stricter.

These characteristics have contributed to the worldwide proliferation of converted firearms in recent years. European states were the first to report the problem in the late 1990s. The use of converted firearms in criminal incidents appears to be particularly high in countries that ban, or heavily restrict, civilian possession of real pistols and revolvers, such as the Netherlands and the United Kingdom (de Vries, 2011, p. 214; Hales, Lewis, and Silverstone, 2006, p. 7). Overall, at least 19 European states have reported confiscating converted blank-firing firearms. Reactivated firearms have also been used in some high-profile attacks, including the January 2015 terrorist attacks in Paris.

The proliferation of converted imitation firearms in particular is also significant in the Middle East and North Africa. Turkey is a major manufacturer of blank-firing firearms, including several popular brands: Atak Zoraki, Ekol/Voltran, Blow, and Target Technologies (King, 2015, p. 4). Over the past six years, authorities in several countries have seized multiple large shipments of Turkish-made replica firearms en route to Djibouti, Egypt, Iran, Kenya, Libya, Somalia, Sudan, Syria, and Yemen (King, 2015, p. 8).

Recirculation of illicit weapons

In addition to diverted legal holdings and illicitly produced firearms, existing stockpiles of illicit weapons represent another source of illicit arms flows. In fact, in a number of conflict zones, weapons and ammunition designed, manufactured,

and distributed decades earlier—specifically in the context of cold war proxy arming—are still in use (Florquin, 2014, pp. 2–3).

A review of arms caches recovered in Afghanistan from 2006 to 2011, Iraq in 2008 and 2009, and Somalia from 2004 to 2011 revealed that the vast majority of seized small arms were AK-type rifles—the same patterns of rifles that have been used by governments and armed groups in these countries for decades (Schroeder and King, 2012, p. 314). These older models of firearms are also commonly available for sale at local open-air and undercover illicit markets, such as those documented by the Small Arms Survey in Lebanon, Pakistan, and Somalia (Florquin, 2013).

Perhaps more surprising, given its consumable nature, small-calibre ammunition produced during the cold war is still circulating widely in conflict areas. A review of 560 varieties of such ammunition documented since 2010 in seven conflict zones in Africa and Syria found that more than half of the identified types of ammunition had been produced before 1990 (Florquin and Leff, 2014, p. 189). Moreover, the age of small-calibre ammunition does not appear to greatly affect its price on the illicit markets of Lebanon, Pakistan, and Somalia (Florquin, 2013, p. 263).

While some ageing weapons and ammunition used in conflicts may have been diverted recently from legal, old surplus stockpiles, there is also evidence of the recirculation of illicit weapons between armed groups, sometimes spanning decades. This is the case in the conflict in the eastern DRC, where enduring armed groups such as the Forces Démocratiques de Libération du Rwanda (FDLR) have acquired weapons from a variety of state and non-state armed forces, both forcibly and through alliances, since the 1990s (Debelle and Florquin, 2015, pp. 199–204).

Conclusion

While the arms shipments arranged by high-profile arms brokers generally capture the headlines, the arms trade is an immensely complex and multi-faceted phenomenon that is often far less sensational in nature. Authorized international transfers take many forms, ranging from temporary exports of a single firearm for use in shooting competitions to the permanent transfer of thousands of weapons to militaries and police forces. The legal domestic trade is equally diverse.

Government arms depots in countries with large and active armed forces often contain a broad array of small arms and light weapons, while armouries in smaller countries that only have constabulary forces may contain few if any light weapons. Civilian markets tend to be more limited since most governments ban (or severely limit) the possession of light weapons by civilians. The types of firearms that can be legally purchased for hunting, sport-shooting, and self-defence vary significantly from country to country, however.

The illicit arms trade mirrors the authorized trade: the vast majority of small arms and light weapons on the black market were legally produced and owned before they were diverted to unauthorized recipients. There are exceptions, of course, such as those weapons which are improvised, craft produced, or converted. But even most craft-produced small arms and light weapons are assembled from components that are acquired from legal markets. Like the authorized trade, illicit arms flows vary significantly over time and from region to region. The types and sources of illicit weapons in one country are often completely different from those in another country, and there are sometimes even differences from region to region. These differences are explained by numerous factors, including—but not limited to—the types of weapons and ammunition available from local and regional sources, and the resources and objectives of illicit end users. Accurately researching and reporting on arms and ammunition therefore requires a nuanced understanding of the weapons identification process and the sources of data on authorized and illicit arms flows.

— **Author: Nicolas Florquin**

Contributors: Khristopher Carlson, Benjamin King, Glenn McDonald, Mihaela Racovita, and Matt Schroeder

CHAPTER 3

Weapons Identification: Small Arms

Introduction

When most people think of ‘guns’, they are thinking of small arms. Broadly speaking, small arms are firearms intended for use by individuals. Small arms are the primary weapons issued to military, law enforcement, and other armed security personnel, and are widely owned and used by civilians for hunting, sport shooting, and other pursuits. The key characteristics of firearms considered to be small arms are their portability (they may be transported and operated by a single individual on foot), and their calibre (less than 20 mm) (ARES, 2017; forthcoming).

This chapter begins with a brief presentation of key types of small arms, addressing their history and technical development. The chapter then provides an overview of the most important physical features and markings by which these arms are identified. It also briefly examines feed devices (such as magazines), accessories, packaging, and shipping documentation, which can provide valuable information about the provenance of firearms. Ammunition for small arms is addressed in Chapter 4.

History and technical development

Today’s small arms have their roots in the Victorian era. Some manually-operated rifles, in particular, have changed little since the late 19th century. The revolver predates the invention of modern cartridges, and the archetypal self-loading pistol created in 1911 as the Colt ‘Government Model’ is still in military use today. Even the automatic machine gun was being sold to authorities around the world by 1897. By the end of the First World War, all of the categories of small arms now in use had been invented, if not finalized in their design or application (ARES, 2017).

Firearms: a brief description

Modern firearms take many different forms, but they all have the following components: a ‘stock’ (and/or pistol grip), a ‘barrel’, and the ‘action’, which refers to the operating components of a weapon.²² One of the main parts of a stock (and, in some guns, the only part) is the ‘butt-stock’. This is the portion of a long gun

22 The word ‘firearm’ was originally coined in the medieval period and referred to any weapon making use of fire for destructive effect. Though it became, and remains for most English speakers, synonymous with ‘gun’, a ‘firearm’ can more properly be considered to be a man-portable gun (ARES, 2016a).

(such as a rifle or shotgun) which is braced against the shoulder when firing. In the case of handguns, the pistol grip is used to secure the weapon when firing. In the years following the Second World War, many long gun designs also came to feature a pistol grip. The barrel is the tube through which the projectile ('bullet') travels after a cartridge is discharged. The group of components that comprise the action varies depending on the type of firearm, but includes the components that load and fire ammunition, and that extract and eject fired cartridge cases (ARES, 2017). Figures 3.1 and 3.2 show the general arrangement and key physical features of a self-loading rifle and self-loading pistol—in this case, a self-loading rifle with a detachable box magazine and a self-loading pistol, respectively.

Figure 3.1 Typical features of a modern military rifle



The ammunition used in most modern firearms is called a 'cartridge'. Cartridges consist of:

- a **projectile**, or bullet, which is fired from the gun;
- a **propellant**, which, when ignited by a primer (below), generates the gas pressure that propels the projectile out of the barrel;
- a **primer**, which consists of chemicals designed to be ignited by a firing pin in the weapon; and
- a **cartridge case**, which contains the components of a complete round of ammunition and, when the weapon is fired, blocks the escape of gases in a way that causes pressure to build up behind the projectile (Goad and Halsey, 1982; Jenzen-Jones, 2016a, p. 13).²³

²³ With the exception of caseless ammunition. There are various types of ammunition, many of which are discussed in Chapter 4.

Figure 3.2 Typical features of a modern handgun

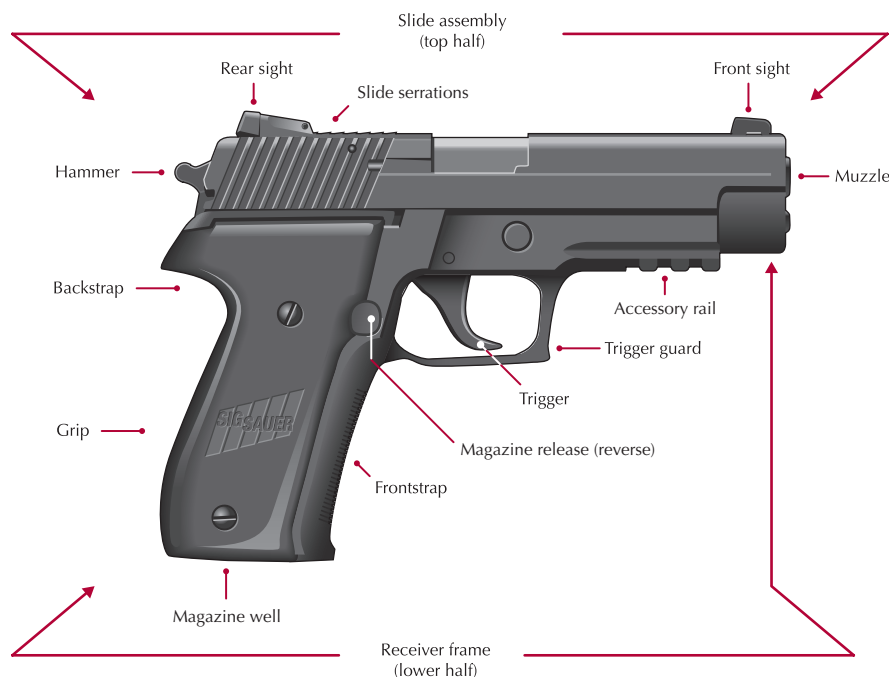

Nearly all firearms function in the same basic manner. The operator pulls the trigger, causing an internal mechanism to allow the weapon's firing pin to strike the primer, located in the base of the cartridge. The primer ignites the propellant, which generates rapidly-expanding gases as it burns. The build-up of pressure from the expanding gas within a sealed chamber (the 'breach') pushes the projectile down the barrel, out of the muzzle, and towards the target (see Figure 3.3). The discharge of a firearm is accompanied by a flash and blast at the muzzle, and by recoil that is typically perceived by the user (ARES, 2017).²⁴

Modern firearms—with the notable exception of shotguns—primarily feature rifled barrels (see Figure 3.4). Rifling refers to the internal geometry, typically either spiral grooves or polygonal faces inside the bore which engage the projectile and cause it to rotate as it is accelerated up the barrel (see Figure 3.5). This

²⁴ This is properly known as 'perceived recoil' or 'felt recoil', but is often referred to simply as 'recoil' (ARES, 2017).

rotation imparts gyroscopic stability to the projectile, ensuring that it flies accurately and point first (ARES, 2016a).

Firearms make use of a variety of operating systems ('actions'). At their most basic, firearms allow the user to load and chamber a cartridge, fire the weapon, and then extract and eject the fired cartridge case. More complex operating systems allow for semi-automatic and automatic fire, in which the firearm is (re)cocked for the next shot when it is discharged (ARES, 2017).²⁵

Figure 3.3 The build-up of gas pressure behind a projectile during the firing sequence of a firearm

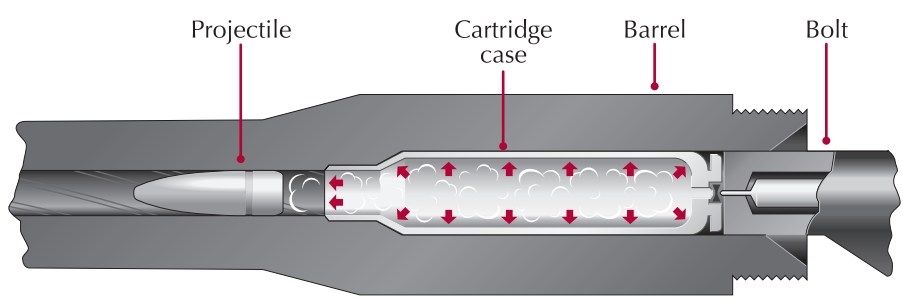

Note: The cartridge case and bolt face provide a gas seal.
Adapted from: Chinn (1955, p. 4)

Figure 3.4 Rifled and smooth-bore barrels

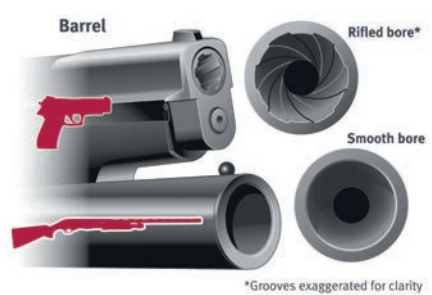
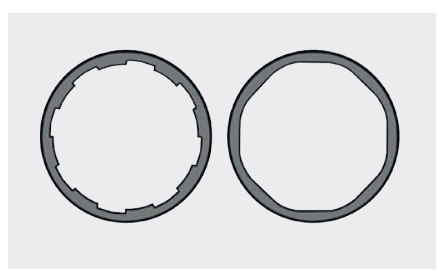

Figure 3.5 Conventional grooved rifling (left) and octagonal polygonal rifling (right)



Source: Wikimedia Commons

25 Automatic firearms are sometimes described as having 'fully-automatic', 'full automatic', or 'full auto' operation. While these terms are commonplace in civilian, military, and occasionally even technical use, the term 'automatic' is sufficient.

In general terms, firearms are either manually-operated or self-loading.

- **Manually-operated firearm:** a firearm which relies on the user, rather than the potential energy stored within a cartridge, to cycle the weapon (ARES, 2017).
- **Self-loading firearm:** a firearm which uses the energy stored in a cartridge to cycle the weapon's action, extracting and ejecting the cartridge case immediately after firing, and chambering a new cartridge from the weapon's magazine (ARES, 2017).

Whether operated by manual or purely mechanical means, each cartridge in a repeating weapon²⁶ is subjected to a similar operating cycle: it is loaded from the feed device (or manually loaded) into the gun's chamber, the bolt is locked to the rear of the breech, the cartridge is fired, the bolt is unlocked, and the cartridge is then extracted from the chamber and ejected. The vast majority of firearms in existence today are repeating firearms.

The most common types of operating system for manually-operated firearms are break-action, bolt-action, pump-action, and lever-action.²⁷ All of these systems rely on the shooter to physically manipulate one or more components of the firearm to unlock the action, extract (and generally eject) the fired cartridge case, chamber a new cartridge, and lock the action (ARES, 2017). These systems are most common among rifles and shotguns.

Self-loading firearms include a wide variety of operating mechanisms. Weapons firing low-powered ammunition typically utilize a simple blowback action.²⁸ More powerful ammunition requires a locked breech mechanism. This may be recoil-operated or gas-operated, or use some form of retarded blowback.²⁹

26 Generally speaking, a 'repeating' firearm is one in which the number of cartridges held in the weapon is greater than the number of barrels, where one or more cartridges are held elsewhere than the firing chamber, and where more than one shot can be fired before the weapon needs to be reloaded (ARES, 2017). Note that not all weapons make use of a locked breech design.

27 Break-action weapons are not repeating firearms, whereas bolt-, pump-, and lever-action types are (ARES, 2017).

28 A simple blowback action is one in which the bolt is not locked to the breech on firing, being held in place only by its own inertia and the return spring. This is only suitable for relatively low-pressure ammunition, such as handgun cartridges or some cartridges for automatic grenade launchers (ARES, 2017).

29 For explanations of these actions, see ARES (2017).

The key distinction within self-loading firearms is between semi-automatic and automatic firearms.

- **Semi-automatic firearm:** a self-loading firearm which is capable of firing only one shot with each trigger pull (ARES, 2017).
- **Automatic firearm:** a self-loading firearm which is capable of firing multiple shots with a single trigger pull (ARES, 2017).

Most rifles in military service today are self-loading designs capable of automatic fire. Semi-automatic versions are available for many of these rifles, which are used for civilian self-defence, law enforcement, and sporting and hunting applications in some countries (Jenzen-Jones, 2017d). It can often be difficult to visually differentiate automatic from semi-automatic variants of the same basic design, and so the term 'self-loading' is preferred in these cases. Self-loading pistols are the dominant class of handgun today, in widespread global use by armed forces, law enforcement and, in many countries, civilians. They are also known as 'semi-automatic pistols' (ARES, 2017).

Handguns

The modern term 'handgun' came into use in the early 20th century as an umbrella term for non-repeating pistols, self-loading pistols (see Image 3.1), and revolvers (see Image 3.2).³⁰ Today the self-loading pistol dominates (see Figure 3.6); revolvers, though still frequently encountered in the civilian world, are less commonly used by militaries or law enforcement personnel. In militaries, pistols are primarily used as weapons for personal defence only. Pistols are still widely used by law enforcement agencies, civilians, and criminals, however, primarily because they are highly portable and concealable (ARES, 2017).

Sub-machine guns

The sub-machine gun (SMG) was conceived as a fully portable automatic weapon that could be employed at close range by an individual user. SMGs have shorter barrels than most machine guns and rifles, and typically fire pistol-calibre

³⁰ Following their introduction in the 19th century, revolvers were commonly known as 'revolver pistols'. This label is uncommon today, but remains technically accurate.

Image 3.1 A Soviet Baikal PM 9 × 18 mm self-loading pistol



Source: N.R. Jenzen-Jones/ARES

Image 3.2 A Belgian C.F. Galand 12 × 15.5 mm revolver



Source: N.R. Jenzen-Jones/ARES

Figure 3.6 Typical arrangement of a modern self-loading pistol, showing some internal components

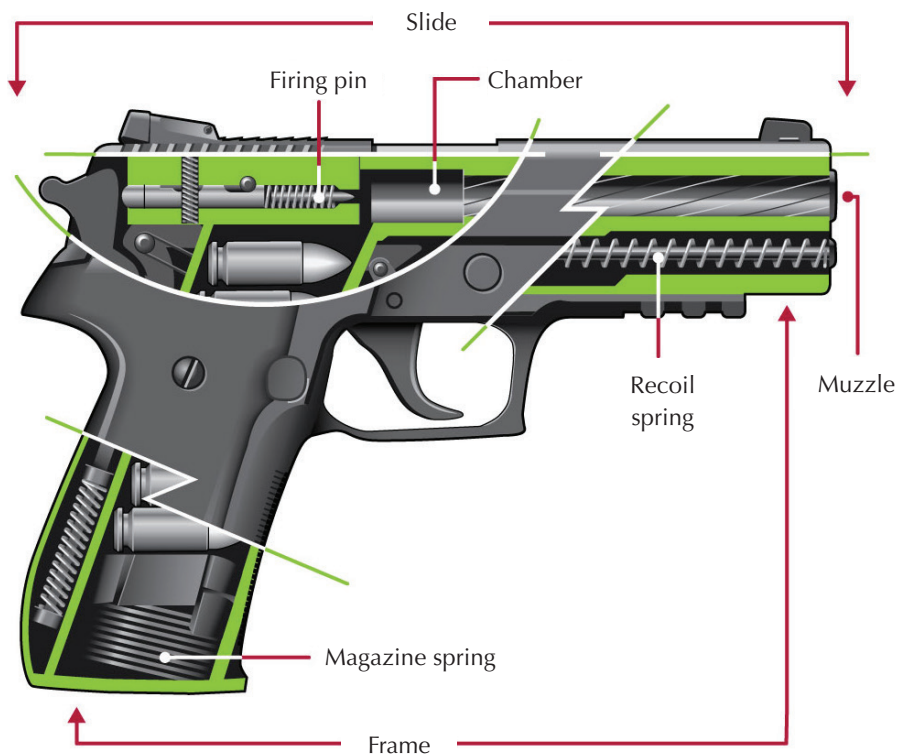

Image 3.3 An Italian Beretta Model 12S 9 × 19 mm SMG



Source: N.R. Jenzen-Jones/ARES

ammunition from high-capacity magazines (see Image 3.3).³¹ Handgun ammunition is significantly less powerful than typical rifle ammunition and requires a shorter barrel to achieve its optimum performance. As a result, SMGs have a shorter effective range (typically around 100 m) compared to rifles and machine guns (ARES, 2017). Their blowback system of operation is very simple to manufacture and maintain, and is the dominant operating mechanism for this category of firearm (ARES, 2016a).

The term ‘SMG’ also includes most firearms described as ‘personal defence weapons’ (PDWs) (see Image 3.4). The latter term is primarily a description of a weapon’s intended role rather than a useful technical distinction, although it may also imply a use of high velocity ammunition intended to penetrate body armour.³² Generally, SMGs are compact and lightweight.

³¹ Both the common 9 × 19 mm Parabellum cartridge and a high-capacity drum magazine originally designed for the Luger pistol (1902) were incorporated into the first deployed SMG in 1918, the German Bergmann MP.18,1 (Forgotten Weapons, 2017b; Popenker and Williams, 2012).

³² Two relatively common rounds in service are the 4.6 × 30 mm HK and 5.7 × 28 mm FN (ARES, 2016a).

Image 3.4 A German Heckler & Koch MP7 4.6 × 30 mm SMG



Note: This type of SMG is regarded by some as a ‘personal defence weapon’. There is a void at the base of the pistol grip; the box magazine is absent in this image. There is also a muzzle protector covering the flash hider.

Source: N.R. Jenzen-Jones/ARES

In recent years, the short-range SMG has fallen from favour among militaries and law enforcement agencies, which increasingly use compact variants of self-loading rifles instead (ARES, 2017; Jenzen-Jones, 2017d).³³

Shotguns

The simplest common modern shotgun design, the break-open breech-loading type, was fully developed by the 1870s (Greener, 1910; Taylor, 2016). Figure 3.7 shows the typical features of a break-action shotgun, in both single-barrel and double-barrel configurations. While break-action shotguns are rarely seen in law enforcement or military service, they remain popular with civilian shooters and criminals, and are sometimes encountered with shortened (‘sawed-off’) barrels and/or stocks to enhance their concealability.

33 The short-range SMG’s fall from favour largely coincided with the introduction and proliferation of assault rifles, especially compact variants such as the Colt XM177 (first introduced in 1966) (ARES, 2016a). Even semi-automatic pistol-calibre carbines used by law enforcement personnel have been largely supplanted by intermediate calibre equivalents.

Figure 3.7 Typical features of a break-action shotgun

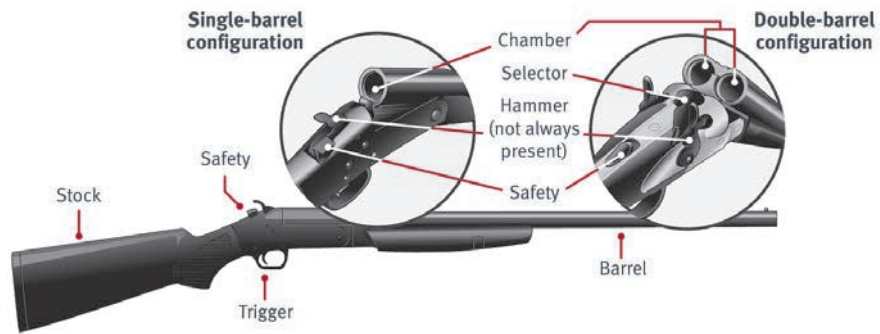

Adapted from: ATF (2018)

The first successful pump-action shotguns were introduced by Winchester in 1897 (Taylor, 2016). These types of shotguns are now in common civilian and law enforcement use (see, for example, Images 3.5, 3.6). Their typical features are shown in Figure 3.8. Bolt and lever-action shotguns of a design introduced in the late 19th century are in limited use, almost entirely by civilians. Self-loading shotguns, using systems of operation developed for machine guns and rifles, did not become popular until the mid-20th century (ARES, 2016a).³⁴ While self-loading shotguns are widely used by sport shooters and law enforcement agencies,

Figure 3.8 Typical features of a pump-action shotgun

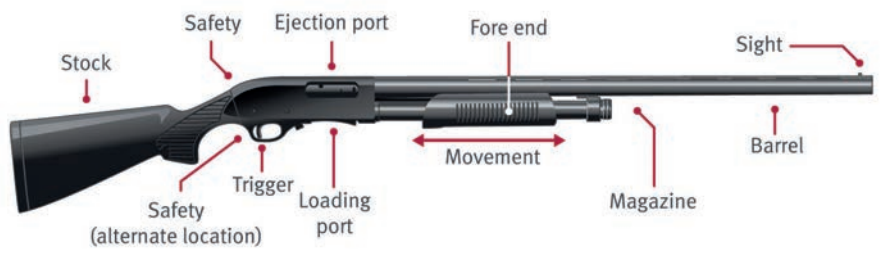

Adapted from: ATF (2018)

34 An example of this type of weapon is the recoil-operated Browning Automatic 5.

Image 3.5 An American Remington Model 870 Wingmaster 12-gauge pump-action shotgun



Source: Bear Arms Firearms Reference Collection via ARES

Image 3.6 An Italian Benelli M1 Super 90 12-gauge self-loading shotgun



Source: N.R. Jenzen-Jones/ARES

true automatic shotguns have never achieved mainstream usage.³⁵ Shotguns have only ever filled very specific niches in military service, but are frequently encountered in conflict zones due to their ready availability on the civilian market and their widespread use by law enforcement personnel (ARES, 2017).

Rifles

In the 1860s, breech-loading rifles and carbines were introduced to take advantage of new self-contained cartridges.³⁶ The definitive manually-operated mechanisms

³⁵ As is the case with rifles, semi-automatic shotguns are sometimes erroneously referred to as ‘automatic shotguns’. They are also referred to as ‘auto-loading shotguns’ or ‘autoloaders’ which may also generate confusion (see, for example, Remington, n.d.).

³⁶ Early rifles were expensive niche weapons, primarily produced for sporting purposes. Military interest was limited to specialist rifle units until the mid-19th century, when rifled muskets firing the Minié-type bullet became common (ARES, 2017).

Image 3.7 A Turkish conversion of a French Berthier Modèle 1907-15 8 × 50R mm bolt-action rifle



Note: Despite being a very old design, similar rifles are still encountered in limited numbers in conflict zones.
Source: N.R. Jenzen-Jones/ARES

still used today emerged from this period of innovation, including the bolt, lever, and pump actions (ARES, 2017; see Image 3.7). Bolt-action rifles remain in limited military service today, often as dedicated sniper rifles with an effective range of more than 1,000 m for individual targets (Jenzen-Jones, 2017c; 2017d; see Image 3.8). Lever- and pump-action rifles, however, have fallen out of favour for military and law enforcement purposes (ARES, 2016a). The French invention of smokeless powder in the 1880s allowed for increased velocities and reduced fouling, resulting in the first self-loading and automatic rifle designs (Jenzen-Jones, 2017d).

Self-loading rifles were first widely adopted during and after the Second World War. They are the primary weapon for most infantry, and are in widespread use among non-state armed groups (Jenzen-Jones, 2017d). Self-loading rifles also

Image 3.8 A Canadian PGW Defence Technologies Timberwolf .338 Lapua Magnum (8.6 × 70 mm) bolt-action rifle



Note: In this case, the bolt-action rifle is fitted with a telescopic sight and suppressor. This type of rifle is representative of a dedicated sniper rifle in modern military service.
Source: Chloe Tousignant/ARES

Image 3.9 A French Manufacture d'armes de Châtellerault Carabine de Cuirassier Modèle 1890 8 × 50R mm bolt-action rifle



Note: This type of bolt-action rifle was historically considered to be a 'carbine'.

Source: N.R. Jenzen-Jones/ARES

dominate law enforcement and civilian markets. Semi-automatic variants of assault rifles, which are often referred to as 'modern sporting rifles' and are popular among civilians in some countries, should not be confused with true (i.e. automatic) assault rifles, nor labelled as such (ARES, 2016a; Jenzen-Jones, 2017b).³⁷

The term 'carbine' is widely used, but it is too imprecise to meaningfully define any particular group of small arms in modern usage and often causes confusion. It originated as a reference to a specific military rifle of reduced size, weight, and smaller calibre issued primarily to cavalry and other units which did not require a full-sized rifle (see Image 3.9). Since then, the term carbine has devolved into a colloquial or marketing term for any relatively short-barrelled shoulder arm, and, as such, has little descriptive value and should be avoided (ARES, 2016a; 2017).

Anti-tank rifles and anti-materiel rifles

Anti-tank rifles (ATR) originated in the First World War as a response to the deployment of the tank in 1916 (see Image 3.10). Typical examples include manually-operated and semi-automatic rifles firing either very high-velocity 7.92 mm ammunition, or larger calibres of 12.7–20 mm, all of which fired solid, armour-piercing projectiles.³⁸ During the Second World War, tank armour became

³⁷ Recent combat experience has resulted in a limited return to more powerful, medium-range, self-loading and automatic infantry rifles (often called Designated Marksman Rifles or DMR) to plug a 'capability gap' and operate out to 800 m (Jenzen-Jones, 2016a).

³⁸ The concept was first embodied in the Mauser M1918 Tankgewehr, functionally a scaled-up bolt-action rifle, and further developed by the Soviets with their PTRS-41, an adaptation of self-loading rifle technology to a much larger 14.5 × 114 mm cartridge (ARES, 2017).

Image 3.10 An Imperial German Mauser Tankgewehr 18 13 × 92SR mm anti-tank rifle



Source: Rock Island Auctions

essentially impervious even to comparatively powerful small- and medium-calibre cartridges, and ATRs fell out of use. Today, the task of defeating tanks has been taken over by combatants armed with recoilless weapons and portable rocket and missile launchers. However, militaries repurposed ATRs for use against other targets, and rifles in similar calibres are now known as ‘anti-materiel rifles’ (AMRs) (ARES, 2017).³⁹

The US Barrett M82 (1982) was specifically developed for the anti-materiel role (see Image 3.11), and its derivatives and similar designs are now in widespread use alongside very limited numbers of older ATRs. AMRs are employed against a variety of targets, including soft-skinned vehicles (vehicles with no armour),

Image 3.11 An American Barrett M82A1 .50 BMG (12.7 × 99 mm) anti-materiel rifle



Source: Wikimedia Commons/Heavenneath

39 Both ‘anti-tank rifles’ and ‘anti-materiel rifles’ are role-based terms, and these weapons should still be described by their technical characteristics and calibre (for example, manually-operated rifle chambered for 12.7 × 99 mm). Several weapons widely considered to be AMRs are technically light cannon (ARES, 2017).

light armoured vehicles, aircraft on the ground, and personnel at long range (up to 2,000 m), and for explosive ordnance disposal (ARES, 2016a; 2017). To maximize effectiveness, these rifles often use ammunition with incendiary and explosive as well as armour-piercing characteristics (see Chapter 4).⁴⁰

‘Assault rifles’

Assault rifles are a specific subset of self-loading rifles. The term ‘assault rifle’ was coined in Germany during the Second World War to describe the Sturmgewehr StG 44, a compact automatic rifle firing shortened ammunition that was more powerful than ammunition used in SMGs but less powerful than ammunition used in military rifles and machine guns (ARES, 2016a; Clapham et al., 2016).⁴¹ The purpose of these weapons was to provide greater effective range than a SMG while also allowing for controllable automatic fire from the shoulder (Jenzen-Jones, 2017d). The definitive assault rifle still in common use globally remains

Image 3.12 A British Imperial Defence Services MG4A5 5.56 × 45 mm self-loading rifle



Note: This type of self-loading rifle is considered by some to be an ‘assault rifle’ and/or a ‘carbine’. It is difficult to visually distinguish this British example from US-made AR-15 and M16/M4 series rifles.

Source: N.R. Jenzen-Jones/ARES

⁴⁰ A modern, in-service example is the Nammo 12.7 × 99 mm NM140F2 multipurpose cartridge (Nammo, 2014, p. 57).

⁴¹ The ammunition used in SMGs has a muzzle energy of approximately 500–800 J, while ammunition used in military rifles and machine guns has approximately 3,000–4,000 J muzzle energy (ARES, 2016a).

the Russian AK type, and its 7.62 × 39 mm cartridge is similarly ubiquitous (see Box 3.1). Assault rifles developed and deployed by Western countries are chambered for lighter cartridges.⁴² The 5.56 × 45 mm cartridges fired by some of these rifles (such as that in Image 3.12), which were inspired by the Armalite AR15, remain a NATO standard and are common in many parts of the world.⁴³ Assault rifles have supplanted both SMGs and other rifles as the new standard infantry weapon (Jenzen-Jones, 2017d; Popenker and Williams, 2004). While the term ‘assault rifle’ can be defined, it is relatively difficult to assess and does not add value to most reports (see Box 3.2).⁴⁴ Its use is therefore not recommended, except in specific circumstances; ‘self-loading rifle’ or ‘automatic rifle’ is generally preferred (ARES, 2017).

Box 3.1 Myths and misconceptions: ‘AK-47’

Strictly speaking, there are no Soviet or Russian AK-47 rifles to be found in the field, as this designation refers to a small number of prototype weapons that were never issued. The original mass-produced rifle based on the AK-47 prototype was designated simply AK (Avtomat Kalashnikova) in 1948, and was followed by the modernized AKM (Avtomat Kalashnikova Modernizirovanny) in 1959.⁴⁵ Similarly, despite persistent accounts in Western publications, there was never a Soviet rifle designated the ‘AK-49’. The first Soviet Kalashnikov to be named for its year of introduction was the AK-74 (Avtomat Kalashnikova obraztsa 1974). There are now nearly 200 variants, derivatives, and copies of AK rifles (both licensed and unlicensed), which are produced throughout the world (Ferguson and Jenzen-Jones, 2014b; Jenzen-Jones, 2018). At least 70 million AK-type rifles have been produced since 1949, making it the most common self-loading military rifle in existence (Jenzen-Jones, 2017d).

The name ‘AK-47’ is often incorrectly applied to any Kalashnikov-derived rifle, regardless of type or country of origin. Even weapons specialists and the original manufacturer (now known as Concern Kalashnikov) have incorrectly used the term AK-47 to refer to AK variants chambered for 7.62 × 39 mm (for example see Image 3.13).⁴⁶ As a result of this indiscriminate usage, most firearms

-
- 42 So-called ‘small-calibre, high-velocity’ (SCHV) cartridges.
- 43 The 5.56 × 45 mm NATO cartridge was joined in the 1970s and 1980s by the Russian 5.45 × 39 mm and the Chinese 5.8 × 42 mm (Jenzen-Jones, 2017d).
- 44 The term is generally defined partly as a function of muzzle energy, being a rifle capable of automatic fire and chambered for an intermediate-power cartridge typically producing 1,300 J to 2,600 J of muzzle energy (ARES, 2017).
- 45 The very first production AK (sometimes called the ‘Type 1’) featured a largely stamped receiver before the ‘Type 2’ was introduced with a milled receiver in 1951 (followed by the ‘Type 3’, which also had a milled receiver) (Ferguson and Jenzen-Jones, 2014b; Jenzen-Jones, 2018). These early AK types may still be encountered in the field; however, even these feature a visibly machined trunnion block and are sufficiently rare that they may be conflated with the more common pre-AKM variants (the ‘Type 2’ and ‘Type 3’).
- 46 See, for example, Concern Kalashnikov (2014).

► identified in the news media as AK-47 rifles are not Soviet/Russian AK models. Most are AKM rifles or other derivatives of the original AK, which appear similar to the untrained eye. It is therefore recommended that the term AK-47 be avoided. When the specific model of a particular rifle cannot be identified, the catch-all term 'AK-type' should be used instead.⁴⁷ If the weapon bears the physical features of a known model, more specific terms, such as 'AK-pattern' or 'AKM-pattern' may be used.

Image 3.13 An Egyptian Maadi Company for Engineering Industries Misr 7.62 × 39 mm self-loading rifle



Note: This is a copy of the Soviet AKMS. Such weapons are often misidentified as visually-similar Soviet/Russian rifles.
Source: N.R. Jenzen-Jones/ARES

Machine guns

Machine guns operate in a similar fashion to contemporary self-loading and automatic rifles (see above). Early machine guns were large and heavy weapons that were mounted on vehicles or semi-mobile mounts, such as heavy tripods. The first light machine guns (LMGs) were fielded in the early 1910s, resulting in the redesignation of the heavier counterparts as 'medium' or 'heavy' machine guns (Gander, 1993; Popenker and Williams, 2008).⁴⁸ Modern LMGs are chambered for rifle ammunition and are usually operated by a single individual but, unlike assault rifles, they are designed for sustained automatic fire (typically in short bursts). They therefore tend to feature heavier barrels and a bipod. Many machine

⁴⁷ 'Kalashnikov-type' is also used, although the weapon in question may be confused with other weapons designed by Kalashnikov and bearing his name, such as the Pulemet Kalashnikova ('Kalashnikov machine gun'), or PK, and the later PKM (Pulemet Kalashnikova Modernizirovanny).

⁴⁸ Indeed, the M1918 Browning Automatic Rifle was directly adapted as a LMG, primarily by the addition of a bipod (Ballou, 2010).

Image 3.14 A Belgian FN Herstal Minimi Para 5.56 × 45 mm LMG



Note: This type of LMG is referred to in US military service as a 'squad automatic weapon'.
Source: N.R. Jenzen-Jones/ARES

Image 3.15 A British L86A2 5.56 × 45 mm LMG



Note: This type of LMG is referred to in British military service as a 'light support weapon'.
Source: N.R. Jenzen-Jones/ARES

guns are belt-fed and/or feature interchangeable barrels, although some have fixed barrels and box magazines. LMGs are also sometimes referred to as 'squad automatic weapons' (SAW) or 'light support weapons' (LSW) (ARES, 2017; see Images 3.14, 3.15).

The general-purpose machine gun (GPMG) is a belt-fed weapon that can be used by dismounted infantry (soldiers operating on foot) or attached to a heavier mount or vehicle for sustained fire applications (Popenker and Williams, 2008; see Image 3.16).⁴⁹ The more flexible GPMG supplanted both the dedicated medium machine gun and so-called 'heavy' machine guns chambered for smaller calibres (such as the Maxim gun) (ARES, 2017).⁵⁰ The subcategory is probably best defined by the Belgian FN MAG 58 (1958) and the Russian PK (1961) types.

Image 3.16 A Hungarian copy of the Soviet PKM 7.62 × 54R mm GPMG



Source: Kristóf Nagy/ARES

⁴⁹ Early examples include the German MG 34 and MG 42.

⁵⁰ The modern HMG is a larger-calibre weapon typically operated by a crew and classified as a light weapon (see Chapter 5).

Box 3.2 Myths and misconceptions: ‘assault weapon’

The term ‘assault weapon’ is essentially meaningless outside of specific legal usage in the United States, where it has been defined by a range of primarily cosmetic features to be found on various designs of military rifles (typically, but not exclusively, assault rifles), rather than the operating characteristics of the weapon itself (ARES, 2017). These definitions, largely introduced in the 1994 Assault Weapons Ban, actually covered civilian-owned, semi-automatic rifles, albeit those closely based upon their selective-fire military counterparts (ATF, 2015; ARES, 2016a).⁵¹ Beyond this, politicians, the popular media, and the general public have adopted the term essentially as a synonym for ‘assault rifle’.

The term ‘assault weapon’ has never been used in specialist circles except when referring to certain types of light weapon, including the M47 Dragon anti-tank guided weapon (US Army, 1982). Without qualifying language, however, the term is so imprecise as to apply to almost any offensive weapon, and it is highly recommended that it should not be used except when referring to a particular model of weapon by name, such as the MK 153 Mod 0 shoulder-launched multipurpose assault weapon (SMAW) (USMC, 2005; see Image 3.17).

Image 3.17 A US Marine test-firing an American Nammo-Talley MK 153 Mod 2 83 mm shoulder-launched multipurpose assault weapon, 2013



Note: This shoulder-fired rocket launcher is categorized as a light weapon.

Source: United States Marine Corps

51 To confuse matters even further, these ‘semi-automatic assault weapons’—a clear contradiction in terms—were sometimes referred to as ‘SAWs’, leading to confusion with the term ‘squad automatic weapon’, described above (ATF, 2015).

Physical features

The following section identifies the key physical features of most small arms and explains how to use these features to identify and analyse individual weapons. The ideal outcome of any analysis of a particular weapon is to identify its type, model, make and/or manufacturer, country of origin, and serial number. This is not always possible for a variety of reasons, but even a more limited analysis can reveal important insights into regional arms flows, and the type and possible sources of weapons acquired by specific government agencies, non-state armed groups, and criminal organizations.

When attempting to identify a weapon, the first step is to examine the whole item in profile. Examining the whole item often allows for the recognition of a distinctive combination of features before each feature is examined individually. As explained above, many small arms share several common features. Each of these features reveals important information about the weapon under examination. Figure 3.9 shows the main parts of a typical rifle, in this case a Soviet AKM self-loading rifle.

Figure 3.9 Typical features of a modern military rifle



Note: With handguns, what might be termed the 'receiver' is typically referred to as a 'frame'. The slide of a self-loading pistol is similar to the 'upper' receiver of a rifle. Pistols by definition lack a butt-stock (ARES, 2017).

Source: Chloe Tousignant/ARES

Image 3.18 A German Mauser Kar98K bolt-action rifle (top) and its component parts (bottom)



Note: The bottom image shows the wooden stock with all of the rifle's other components, including stock fittings, removed.
Source: Othais McCarthy

Stocks, butt-stocks, and fore-ends

Stocks were originally one of three primary components of primitive firearms (hence the expression 'lock, stock, and barrel' ; see Image 3.18 for an example of a weapon and its components). The stock contained and protected the two other parts; it also offered surfaces for the user to grasp and shoulder the weapon. Many recent designs have moved away from this concept, relying instead on the receiver to serve these functions, in concert with separate butt-stocks, fore-ends, and pistol grips (see below). Nonetheless, the stock remains a key component of many designs.

Butt-stocks (also 'buttstocks') are the portion of a weapon designed to be braced against the shoulder. Butt-stocks promote accuracy and, where relevant, control automatic fire. They may be integral to the stock itself or a separate component. In many modern designs, the butt-stock is the only 'stock' on the weapon (hence the terms 'stock' and 'butt-stock' are frequently used interchangeably). Most butt-stocks are either fixed (see Images 3.19a, d) or collapsible.

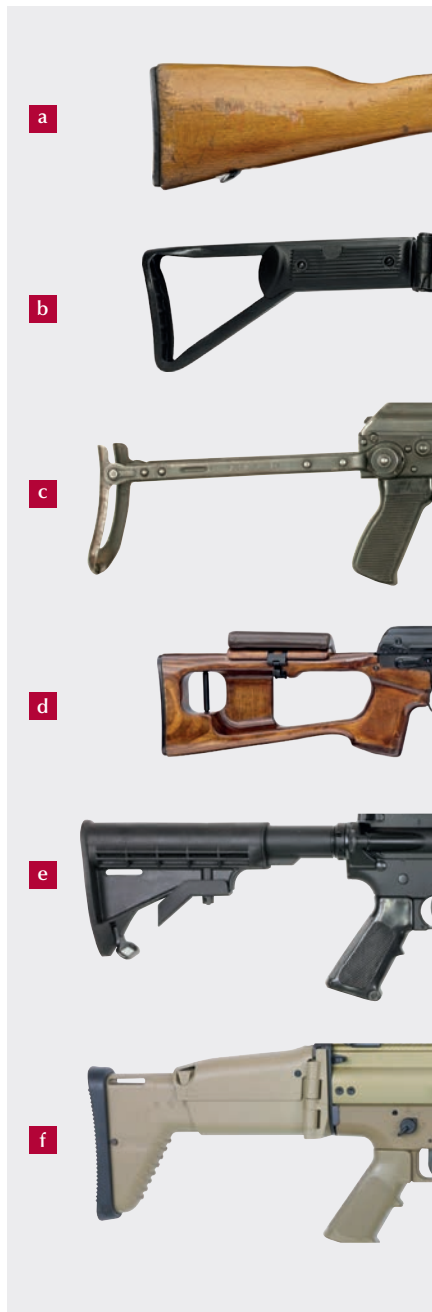
Image 3.19 Examples of butt-stocks

Collapsible butt-stocks are typically top-folding, under-folding (3.19c), side-folding (3.19b, f), or telescoping or 'collapsible' (3.19e). Some folding stocks are also telescoping (3.19f). Modern butt-stocks, especially those fitted to precision rifles, often incorporate other adjustable components, such as cheek pieces.

Fore-ends, or handguards, are the portion of the weapon designed to be grasped with the support hand, that is, the hand that is not used to pull the trigger. Handguards often cover portions of the barrel that would quickly become too hot to handle, particularly during automatic fire. Collectively, fore-ends and butt-stocks (along with other non-critical, ergonomic components of the weapon, such as a pistol grip) are often referred to as 'furniture'. These individual components are most often made of wood (Images 3.20a, b, c, d), polymer (3.20e, f), or metal (3.20g). In some weapons, such as pump-action shotguns, the fore-end may serve a mechanical purpose.

Note: (a) A fixed wooden butt-stock on a Chinese Type 81 self-loading rifle; (b) A side-folding metal and polymer butt-stock on a Chinese Type 81-1 self-loading rifle; (c) An under-folding metal butt-stock on a Yugoslavian Zastava M70AB2 self-loading rifle; (d) A fixed wooden 'skeletonized' thumb-hole stock on a Russian SVD self-loading rifle; (e) A telescoping ('collapsible') multi-position polymer butt-stock on a British Imperial Defence Services MG4A5 self-loading rifle; (f) A side-folding, telescoping polymer butt-stock on a Belgian FN Herstal SCAR-H self-loading rifle.

Sources: N.R. Jenzen-Jones/ARES; Robert Stott; Small Arms Survey

Image 3.20 Examples of fore-ends

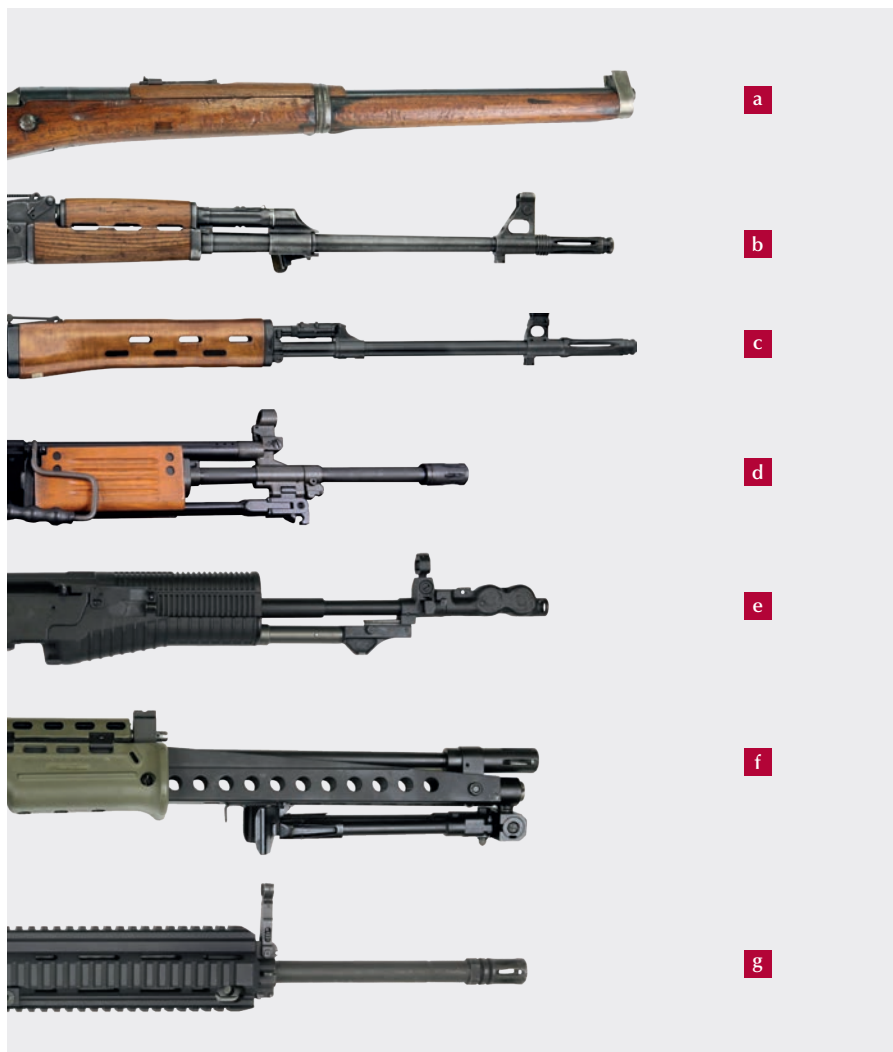

Note: (a) A wooden ‘full-stock’ fore-end on a Turkish conversion of a French Berthier Modèle 1907-15 bolt-action rifle; (b) A wooden handguard on a Serbian Zastava M76 self-loading rifle (note gas tube above barrel); (c) A wooden laminate handguard on a Russian SVD self-loading rifle (note gas tube above barrel); (d) A wooden ‘slab-style’ handguard on an Israeli IMI Galil ARM self-loading rifle (note gas tube above barrel, and stowed carrying handle and bipod); (e) A polymer fore-end on a Russian AN-94 self-loading rifle (note gas tube below barrel and unusual muzzle device); (f) A polymer fore-end and metal ‘outrigger’ barrel support on a British L86A1 LMG (note the stowed bipod); (g) A metal ‘quad-rail’ fore-end (featuring accessory rails at the 12, 3, 6, and 9 o’clock positions) on a German Heckler & Koch HK416D self-loading rifle.

Sources: N.R. Jenzen-Jones/ARES; Small Arms Survey

Fore-ends may also feature bipods, bayonet lugs, rail interface systems, or leaf sights for launching grenades. Rail interface systems are increasingly common (see Image 3.20g). Rail systems provide attachment points for a range of accessories, but are primarily intended for mounting optical sights. Such rails are also sometimes attached, either permanently or as an accessory, to the receiver of a firearm. The most popular rail system is the US standard M1913 ('Picatinny') rail, from which the standard NATO rail was derived (see Images 3.20g and 3.21).⁵²

Image 3.21 A US military M4 self-loading rifle with various upgrades



Note: The fore-end features accessory rails (in this case MIL-STD-1913 'Picatinny' rail) at the 12, 3, 6, and 9 o'clock positions, as well as a length of accessory rail on the upper receiver surface. An optical sight is mounted to the receiver accessory rail and a combined forward-grip/bipod is mounted to the 9 o'clock position of the fore-end 'quad-rail'.

Source: US Army

Barrels and muzzle attachments

As explained above, the barrel of a firearm is a critical pressure-bearing component through which the projectile is accelerated before it leaves the weapon (through the muzzle) and flies towards the target. Many models and variants of firearms are most easily differentiated by their barrel length, and several 'families' or 'series' of firearms include a number of models that are essentially the same except for their barrel length (see Image 3.22). It is important to be aware that

⁵² For further information, see Arvidsson (2009).

barrels and muzzle attachments are occasionally swapped out for barrels of different lengths or fitted with different attachments, either permanently or temporarily. For example, the barrel of the Beretta ARX series of rifles can be removed and replaced with a different barrel in seconds (Ferguson, Jenzen-Jones, and McCollum, 2014). Such cases highlight the importance of precisely documenting and reporting on weapons exactly as they are encountered.

Muzzle attachments include a range of devices affixed to a weapon's barrel to achieve a desired effect. These are most commonly flash suppressors (often called 'flash hiders'), compensators, and/or muzzle brakes. Flash suppressors reduce the visibility of muzzle flash to observers by dispersing flammable waste gases as they emerge from the barrel, and preventing them from reigniting.⁵³

Image 3.22 Barrels of different lengths on Israeli IMI Galil family weapons



Source: Small Arms Survey

53 It is important to note that the spectacular muzzle flashes featured in movies and video games are most often artificially produced, and are not representative of actual flashes, particularly not of muzzle flashes observed during daylight.

Flash suppressors vary in size, shape, and design, from the simple cone seen on the Russian RP46 machine gun, to the enclosed 'bird cage' of the M16A2 or SIG 540 and 550 series (Image 3.23e), and 'prong' designs on the FN SCAR series of rifles (Image 3.23g). Various muzzle devices may be fitted to different models of firearms within the same family of weapons.

Compensators literally 'compensate' for the effects of recoil that cause the muzzle of a firearm to rise when fired. To this end, they redirect muzzle gases to counteract the recoil forces (see the distinctive AKM-pattern 'slant brake' in Image 3.23d). They are typically highly effective, but actively increase sound signature and generate significant lateral muzzle blast.

Other common attachments include bayonet lugs, 'stand-off' breaching devices (Image 3.23h), rifle grenade launching spigots, which are typically found on military rifles (Image 3.23i), and sound suppressors (see Box 3.3).

Image 3.23 Examples of muzzle attachments



Note: (a) A bare muzzle on a US Guide Lamp M3 SMG; (b) A threaded muzzle on an Italian Beretta Model 125 SMG; (c) A thread protector or 'muzzle nut' on a Chinese Type 56-1 self-loading rifle (note also the under-folding integral bayonet).

Image 3.23 Examples of muzzle attachments (continued)



Note: (d) A compensator/flash suppressor on a Soviet AKM self-loading rifle; (e) A 'bird cage' style flash suppressor on a Swiss SIG SG 540 series self-loading rifle; (f) A 'modified bird cage' flash suppressor on a Spanish CETME AMELI LMG (note also folding bipod); (g) A 'three-prong' type flash suppressor fitted to a Belgian FN Herstal SCAR-H; (h) A 'stand-off' muzzle brake/breaching device on a Russian Saiga-12 series self-loading shotgun; (i) An integral grenade-launching spigot muzzle on a Chinese Type 81 self-loading rifle.

Sources: N.R. Jenzen-Jones/ARES; Small Arms Survey

Box 3.3 Myths and misconceptions: ‘silencers’

So-called ‘silencers’, also known as suppressors or moderators, are muzzle devices or barrel designs intended to reduce the noise of firing a weapon.⁵⁴ Suppressors are most commonly found on rifles (see Image 3.24), SMGs, and handguns. However, suppressor designs have also been produced for many other firearms. The most common modern designs comprise a combination of one or more expansion chambers and a series of ‘baffles’, which reduce the velocity of muzzle gases and, consequently, the noise signature of the firearm. In many cases, suppressors also reduce muzzle flash and lead to increased accuracy (Paulson, 1996).

The term ‘silencer’ is misleading, as weapons fitted with these devices are not rendered silent. In most cases, suppressors reduce the decibel (dB) level of gunshots to a ‘hearing safe’ level (Paulson, 1996). The degree of sound suppression varies by weapon and suppressor design, calibre, cartridge, projectile, propellant type, and other factors. Suppressors are commonly portrayed as tools of assassins and hitmen but, in reality, they have a wide range of applications. In some jurisdictions, using suppressors is explicitly understood as an appropriate way to reduce hearing damage to the shooter, to reduce noise disturbance during hunting or sports shooting near residential areas, to avoid panicking livestock, and to enhance safety on firing ranges by allowing for clearer communication (BASC, 2009; Home Office, 2016).

Image 3.24 A Finnish Ase Utra suppressor fitted to an early model Australian Thales EF88 5.56 × 45 mm self-loading rifle



A Finnish Ase Utra CQBS-BL model suppressor and its ‘quick-detach’ muzzle device.

Source: N.R. Jenzen-Jones/ARES/Ase Utra

- 54 While ad hoc solutions for suppressing the audible signature of a weapon have been used irregularly since the advent of firearms, the first commercially successful design was produced by Hiram Percy Maxim in the early 1900s, and patented in 1909 (McCollum, 2012). It was referred to in early advertising as the ‘Maxim Silencer’ and the patent title is ‘Silent firearm’ (Greener, 1910; Maxim, 1909).

Magazines, drums, belts, and clips

Arms are commonly encountered with ammunition, often found loaded into box magazines, drum magazines, belts, and clips (see Box 3.4). Collectively, these items are known as ‘feed devices’.⁵⁵ The most commonly encountered feed devices are detachable box magazines (see Image 3.25). These items are traditionally made of stamped and often ribbed metal, but may also be plastic, and are sometimes translucent. Crucially, they include a spring and a follower to permit feeding of cartridges. Magazines often have a distinctive shape, which makes them useful for identifying the weapons to which they are attached. AKM-pattern weapons, for example, are often noted for their distinctive banana-shaped magazines. The shape of these magazines is markedly different from AK-74 magazines, which are straighter in appearance.

‘Drum’ magazines are higher capacity derivatives of the detachable box magazine. In drum magazines, cartridges are stored in a circular (rather than linear) arrangement.⁵⁶ Common drum magazines hold between 40 and 100 cartridges (see Images 3.26 and 3.27).

Image 3.25 Examples of detachable box magazines



Note: (a) A metal detachable box magazine with a slight curve to its profile, fitted to a German Heckler & Koch HK416D self-loading rifle; (b) A metal detachable box magazine with a pronounced curve to its profile, fitted to a Serbian Zastava M70B1 self-loading rifle; (c) A metal detachable box magazine with a painted finish and polymer butt-plate, fitted to a Belgian FN Herstal SCAR-H self-loading rifle; (d) A metal detachable box magazine fitted to an Italian Beretta Model 12S SMG; (e) A translucent polymer detachable box magazine fitted to a German Heckler & Koch HK417 self-loading rifle.

Source: N.R. Jenzen-Jones/ARES

⁵⁵ Note that although ammunition boxes (including drum-type examples) are often installed into fixtures on a machine gun mount for convenience and to increase the reliability of feed, they do not themselves constitute a feed device.

⁵⁶ Some arrangements are helical (see Image 3.26).

Image 3.26 Detachable drum (left) and helical drum (right) magazines



Sources: Lposka/Wikimedia Commons; Vitaly V. Kuzmin

The highest capacity feed devices are generally machine gun belts, which include disintegrating and non-disintegrating varieties. Disintegrating belts feature links that are separated during the firing cycle and are thrown clear of the weapon in a similar fashion to empty cartridge cases (see Image 3.28b). In most cases, they may be collected and reused. Non-disintegrating belts (sometimes called ‘continuous belts’) are older, but are still in widespread use (see Image 3.28a). Belts and links are often useful for identification, as are the belt feed mechanisms of machine guns (see Image 3.29). For example, the visually-similar DShK and DShKM heavy machine guns have different feed mechanisms (see Image 3.30).⁵⁷

Image 3.27 A non-disintegrating belt of 7.62 × 39 mm cartridges contained within the external drum-type container of an RPD LMG



Source: Kristóf Nagy/ARES

⁵⁷ While heavy machine guns are technically light weapons, Image 3.30 provides an excellent example of differentiating otherwise similar looking guns.

Image 3.28 Non-disintegrating and disintegrating machine gun belts

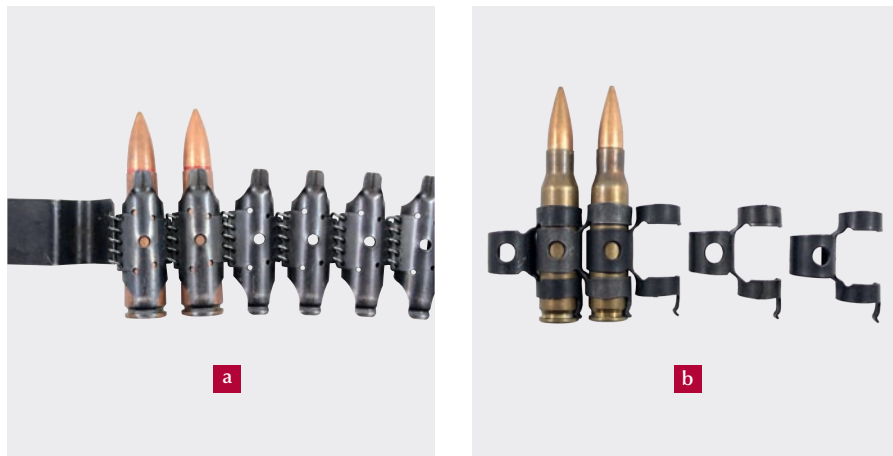

Note: (a) Non-disintegrating belt (7.62 × 39 mm cartridges in a belt used by the Soviet RPD LMG); (b) Disintegrating belt and links (7.62 × 51 mm cartridges in M13 links, as used by the American M240 general-purpose machine gun, for example).
Source: Jack Dutschke/ARES

Image 3.29 Left- and right-side views of a typical belt feed mechanism, including top cover, in this case an FN Herstal Minimi LMG

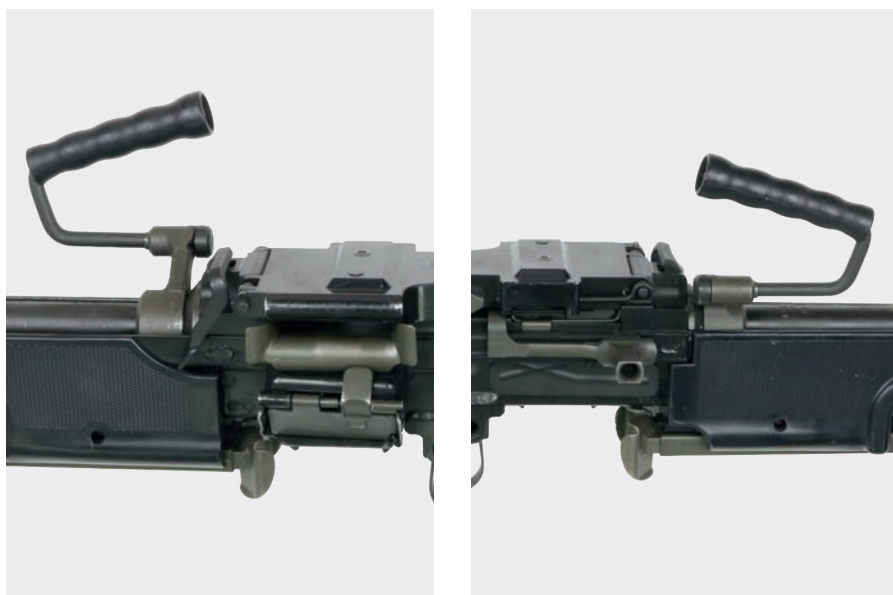

Source: N.R. Jenzen-Jones/ARES

Image 3.30 The belt feed mechanisms of DShK (left) and DShKM (right) HMGs



Note: These mechanisms exhibit distinctive differences in geometry, which is an important differential identification feature for distinguishing these otherwise similar guns.

Source: N.R. Jenzen-Jones/ARES

The presence (or absence) of a certain type of feed device sometimes provides clues regarding sources of weapons and other items, the level of weapons knowledge of the user, or other logistical considerations. Criminals sometimes remove a weapon from a crime scene but abandon used magazines or drums, which may allow for partial identification of the weapon system. For example, magazines such as those for AKM- or FN Herstal FAL-pattern weapons, which are designed to be ‘rocked’ into place and retained by means of a pivoting ‘paddle’, have lugs at the front and rear that can be easily identified. Magazines designed to be simply pushed into place will have a slot into which the magazine catch locates, such as the push-button found on AR15-pattern rifles (see Image 3.31). Belts and links provide similar clues. Links, in particular, are rarely recovered by combatants.

Typically, 'Western' machine guns employ disintegrating links, while equivalents from former-Warsaw Pact countries use non-disintegrating belts. There are exceptions, of course. Some Warsaw Pact models have been redesigned (or converted) to use disintegrating belts and some 'Western' machine guns use non-disintegrating belts. The FN Herstal MAG, for example, has been offered to customers in both configurations (FN, c.1990).

Feed devices may also feature their own markings, which are described under the 'Weapon markings' section, below. However, as magazines are the single most interchangeable component of a firearm, these markings may reveal little about the weapon with which they are used.

Image 3.31 AR-15-type (left) and AK-type (right) magazines



Note: Identifying characteristics include the slot into which the magazine catch locates on the AR-15-type (M16) magazine, and the pronounced lugs at the top of the AK magazine, the rear of which is retained by means of a pivoting 'paddle'-type magazine release.

Source: Kristóf Nagy/ARES

Box 3.4 Myths and misconceptions: 'clip' or 'magazine'?

The word 'clip' is frequently misused in place of 'magazine'. In fact, clips are a completely different type of feeding device. Unlike magazines, clips generally lack a significant spring or follower, relying upon the feed mechanism of the firearm and/or the user to feed the clip and/or its ammunition into the weapon (see Image 3.32). There are several types of clips. 'En bloc' clips are retained within the receiver until empty and then, typically, automatically ejected by the firearm (Ferguson, 2016). 'Chargers' or 'stripper clips', which are not generally loaded into the firearm, are simple strips, typically made of metal, shaped to hold several cartridges and store them conveniently for rapid loading into a magazine (Diehl and Jenzen-Jones, 2012).⁵⁸ A final form of clip is the 'moon' (circular) or 'half-moon' (semi-circular) clip used to hold revolver cartridges in groups for faster re-loading. Unlike common use of the charger clip or the en bloc clip, the moon clip is retained within the weapon until manually expelled along with the empty cartridges (ARES, 2017).

Image 3.32 Clips versus magazines

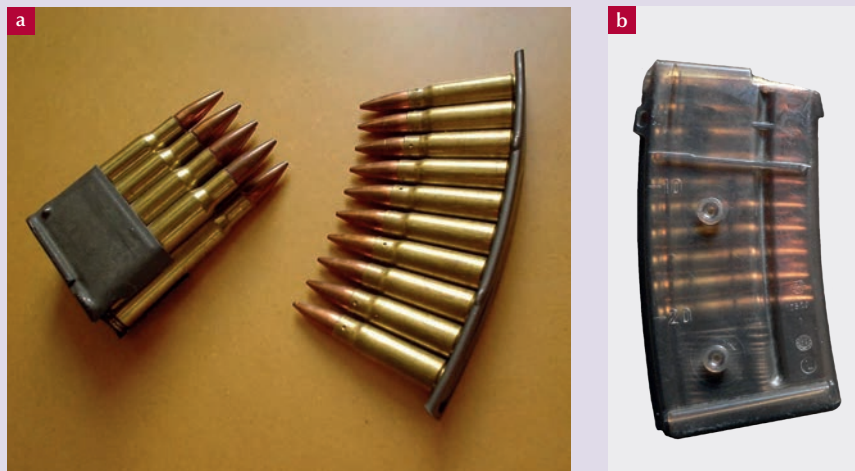

Note: (a) Examples of en bloc (left) and charger/stripper clips (right). (b) A (transparent polymer) removable box magazine for comparison.

Source: Wikimedia Commons/Amenhtp/Rama

Finishes

The finish of certain components of a weapon can serve as an important identifying characteristic (see examples in Image 3.33). 'Finish' is the catch-all term used to describe a variety of processes which protect a firearm from handling, wear,

⁵⁸ Chargers or stripper clips are sometimes made of other materials, including plastic and cardboard.

Image 3.33 Examples of firearm finishes



Note: These finishes are offered by a US company selling reproduction ‘Old West’ firearms.

Source: Cimarron Firearms Co

and the elements. Unfinished metal components are typically at risk of rusting, especially in field conditions.⁵⁹ Wooden components are also finished, generally with various oils, waxes, and sealants. In some cases, firearms may be finished to a high standard. These weapons are sometimes known as ‘luxury’, ‘premium’, or ‘presentation’ guns, or by their make or manufacturer’s grading system.⁶⁰ They often feature nickel, silver, or gold metal finishes (see Box 3.5), wooden components that are carved or have distinctive patterns, inlaid precious materials, and engraving.⁶¹

Finished items come in a wide array of colours, but the most common finish formulation is ‘bluing’ (sometimes ‘blueing’), named for its distinctive blue to blue-black colouration. The term ‘bluing’ is sometimes used to refer more generally to a wide range of oxidation processes, including ‘hot’ and ‘cold’ bluing, browning, and phosphatizing (known commercially as ‘Parkerizing’ or ‘Bonderizing’) (Muel-ler and Olson, 1968). Additionally,

59 Unfinished firearms and metallic firearms components—that is, those which remain bare metal—are often referred to as being ‘in the white’.

60 Different manufacturers may use a range of terms such as ‘presidential grade’, ‘double fine’, ‘AAA’, etc.

61 These distinctive patterns, which result from various grain orientations, are the ‘figure’ of the wood (Wood Magazine, n.d.). Distinctive wood figure, along with scratches, dents, and other marks, may help to distinguish a particular weapon.

Image 3.34 A range of firearms-specific paint finishes



Source: Cerakote

metal plating has long been a common method of preventing corrosion on firearms and other metal products.⁶² The most common plating consists of silver-coloured finishes, such as silver, nickel, or chrome.

While bluing remains the dominant traditional method of firearms finishing, paint coatings are becoming more popular (see Image 3.34). Some paints have improved in quality to the point that they are as resilient as bluing, while remaining simpler and cheaper to apply (Cerakote, 2017a; 2018). They range in quality and complexity from a single coat of commercial spray paint to more complex and professional systems involving multiple priming layers and oven curing at specific temperatures (Cerakote, 2017b). In some cases, both oxidation processes and paint are applied to give a maximum amount of protection to a firearm.⁶³

62 Most plating methods are electrolytic ('electroplating'), involving the submersion of the part to be plated in an electrolyte solution containing dissolved ions of the desired metal compound. An electric current is used to deposit these ions on to the surface of the part being plated. Electroless plating is also used for some applications, and relies on an autocatalytic reaction instead of electricity (SPC, n.d.). Modern arms now often incorporate aluminium components, which cannot be blued chemically, and these components are typically anodized—a type of electrolytic metal plating. Plating is also used on steel components, generally to apply a silver or nickel finish for decorative purposes or a chrome finish to resist corrosion more effectively than bluing. Various vacuum deposition methods, most often physical vapour deposition (PVD) or chemical vapour deposition (CVD), are also sometimes used to produce thin films and coatings on various components (Mueller and Olson, 1968; SPC, n.d.).

63 See, for example, *Forgotten Weapons* (2017c).

Box 3.5 Myths and misconceptions: ‘golden guns’

When expensive or ornate guns are found in conflict zones, they often become the basis of exaggerated claims and tall stories. Weapons of this type, many of which are finished in gold or gold-coloured plating, are often attributed to overthrown dictators and other high-ranking former regime officials. Such stories are notoriously difficult to verify. In Libya, for example, Western media were fascinated by tales of a ‘golden gun’ captured from Colonel Qaddafi himself.⁴³

Contrary to some media claims, there is no single ‘golden gun’ of this type in Libya. In fact, 50 ‘golden’ Belgian-made ‘Renaissance’ grade pistols were exported to Libya as part of a 2009 arms deal. The weapons were intended for a brigade commanded by one of Qaddafi’s sons (Jenzen-Jones, 2016c). They are all engraved with custom details, including the name of the brigade, and feature customized hardwood grip panels inlaid with the Libyan seal (see Image 3.35).

Image 3.35 An FN Herstal High-Power ‘Renaissance’ grade handgun, documented in Misrata, Libya, July 2016



Source: Stanislav Krupa via ARES

These handguns have now been documented in several locations in Libya, including on illicit arms markets operating via social media, with the sellers often claiming the weapon in question belonged to Qaddafi. Other guns reportedly belonging to Qaddafi include a Smith & Wesson revolver and an FN Herstal Five-seveN self-loading pistol (ARES, n.d.; Krupař, 2016).

While high-ranking military and government personnel in conflict zones may own presentation grade guns, researchers should thoroughly investigate third-party claims regarding the provenance of these weapons. Some guns of this type may be visually unique and easily tied to a particular individual or incident. Many others, however, are produced in quantity and require a close examination of both the individual weapon’s physical features, and unique identifying markings such as its serial number. Weapons of this type may have very interesting stories attached to them, but will frequently become a target for exaggeration and deception.

64 See, for example, Gatehouse (2011; 2016).

Weapon markings

Markings are words, letters, numbers, and symbols intended to convey information about the weapon, such as its make and/or manufacturer, country of origin, model, calibre, modes of operation, exporting or importing company or country, serial number, etc. The markings on small arms and light weapons are often one of the best sources of identifying information. The vast majority of arms are marked by the manufacturer, and many are also marked by parties that transfer, import, export, or assemble the weapons (Jenzen-Jones and McCollum, 2016).

Markings were traditionally engraved or stamped by hand. Most markings were either machine stamped, often pressed deep into the metal by a powerful roller tool ('roll-marked'), or cast in place (in which case they may sometimes be raised rather than depressed). Modern markings are often engraved, etched with

Image 3.36 Factory markings reflecting manufacture prior to and after November–December 1971



Note: (a) Factory marking reflecting manufacture prior to November–December 1971, marked: 'FABRIQUE NATIONALE D'ARMES DE GUERRE–HERSTAL–BELGIQUE'. (b) Factory marking reflecting manufacture after November–December 1971, marked: 'FABRIQUE NATIONALE HERSTAL BELGIQUE'.

Source: Jenzen-Jones and Spleeters (2015)

lasers, or, in the case of polymer components, applied using heat. Weapons are marked during and, in some cases, after production (Jenzen-Jones and McCollum, 2016).

Changes in the location, style (including font), content, and other aspects of markings often provide important clues regarding the provenance and date of manufacture of a particular weapon. For example, between November and December 1971, FN Herstal amended its factory marking from ‘Fabrique Nationale d’Armes de Guerre Herstal Belgique’ to ‘Fabrique Nationale Herstal Belgique’ (see Image 3.36). The former factory name marked on a rifle thus indicates that it was made before November 1971 (Jenzen-Jones and Spleeters, 2015). This is one way of determining the age of weapons even when production dates are absent or not visible.⁶⁵ Investigators should also be aware of counterfeit and reproduction firearms, which may be marked in a misleading or confusing manner (see Box 3.6).

Box 3.6 Counterfeit and reproduction firearms

Counterfeit or copy weapons are produced in certain parts of the world, particularly in the Khyber Pakhtunkhwa region of Pakistan and in the Philippines (see Chapter 6). These weapons are sometimes marked in a way that does not reflect their true origin, model, or other properties. The spurious markings, which often mimic the markings on authentic firearms, are used to increase the market value and/or obscure the point of origin of the counterfeit weapon (Hays and Jenzen-Jones, 2018) (see Images 3.37 and 3.38). Reproductions of historical arms are produced both for and by consumers interested in weapons which may not otherwise be readily available, including civilian ‘copies’ of military weapons. These firearms are often produced by legitimate manufacturers and marketed as reproductions (see Image 3.39).⁶⁶ Nonetheless, the physical features and markings on such weapons may confuse some investigators, especially if not closely scrutinized. Similarly, some weapons are refurbished or refinished in ways that are not consistent with their original purpose or design. For these reasons, markings should always be assessed in combination with the physical characteristics of a weapon.

Image 3.37 Markings on a Chinese-made counterfeit pistol, purporting to have been produced by FN Herstal in Belgium



Note: The markings that the producer attempted to replicate should have read: ‘FABRIQUE NATIONALE D’ARMES DE GUERRE HERSTAL’.

Source: McCollum (2014b)

65 See, for example, Jenzen-Jones and Elliott (2015).

66 See, for example, Reed (2016).

- **Image 3.38** Spurious markings on a self-loading rifle falsely claimed to be an AK-103



Note: This self-loading rifle was offered for sale on the black market in Yemen. It featured black polymer furniture and an AK-74-type muzzle brake, making it physically similar to an AK-103.

Source: ARES (n.d.)

- Image 3.39** The Troy Industries GAU-5/A/A, a modern reproduction of the Vietnam War-era GAU-5/A self-loading rifle



Note: This self-loading rifle was adopted by the US Air Force and famously used by US special operations forces (the so-called 'Son Tay Raiders') during Operation Ivory Coast in 1970. An inspection of the reproduction markings may fool a non-specialist, and it is difficult to distinguish the fact that it is a reproduction by an assessment of its physical features without close inspection.

Source: Troy Industries

Make, manufacturer, factory, arsenal, and country markings

Small arms usually have markings that denote the make and/or manufacturer, country of origin, and, less frequently, the production facility and/or storage arsenal. These markings are often useful in identifying and tracking weapons.

Factory, arsenal, and country markings can dramatically reduce the number of potential countries of origin and manufacturers of a particular weapon, which, in turn, aids in the identification of the model or variant of the weapon. Manufacturer and factory markings consist of the name of the manufacturer or factory, an alphabetical or alphanumeric code, a symbol, or a combination thereof. Military firearms, particularly those which have traditionally been produced at state facilities, are rarely marked with a country of origin, but are likely to feature the name (or factory code or logo) of the factory where the weapon was produced (see Image 3.40).

Civilian and law enforcement weapons typically display the commercial name of the manufacturer, but sometimes are marked with only country of origin, or even country of import markings. However, with the shift later in the 20th century towards commercial procurement of military weapons, combined with the

Image 3.40 Examples of factory markings

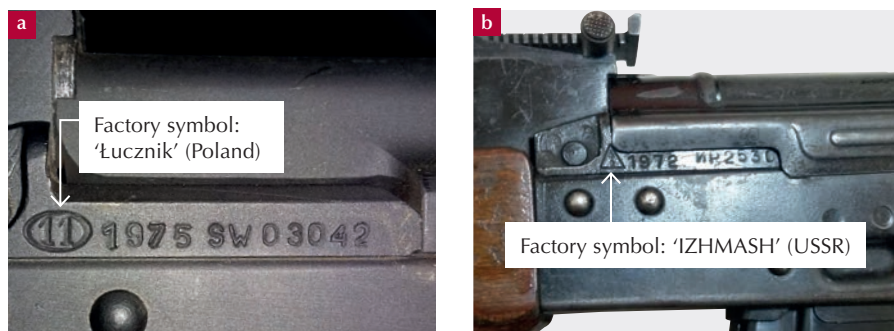

Note: (a) Factory marking (11 in oval; FB “Łucznik” factory code) on a Polish Zakłady Metalowe “Predom-Łucznik” kbk AKMS self-loading rifle. Note also the production date (1975) and serial number (SW03042), the latter stamped in part on the bolt assembly (visible as the top cover has been removed). (b) Factory marking (arrow in triangle; IZHMAHSH factory code)⁴⁶ on a Soviet AKMS self-loading rifle. Note also the year of production (1972) and serial number (MP2530), the latter stamped in part on the top cover (530).

Source: ARES (n.d.)

67 Now marketed under the ‘Kalashnikov’ brand of Concern Kalashnikov.

Image 3.41 Make, manufacturer, and country of origin markings on a German Heckler & Koch USP self-loading pistol

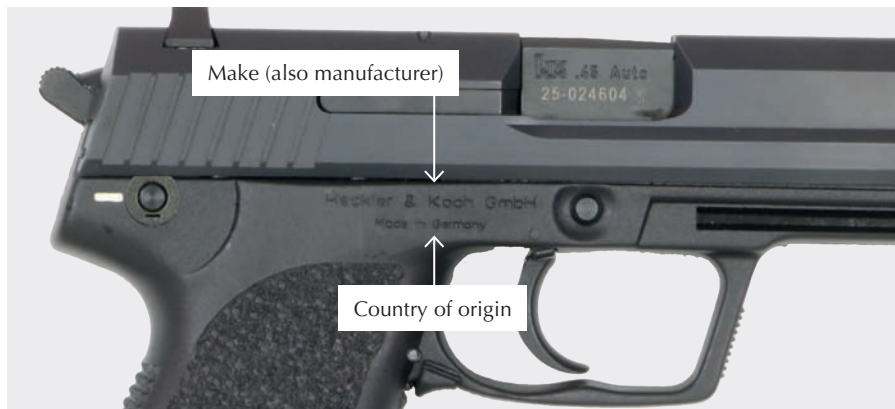

Note: This image also shows the stylized 'HK' logo, calibre marking (.45 Auto), and serial number (25-024604).
Source: N.R. Jenzen-Jones/ARES

introduction of various legal controls on markings in many states, most recently-produced weapons feature make and/or manufacturer markings as well as a country of origin marking (see Image 3.41). In either case, the originating town, city, or even full postal address of the manufacturer is sometimes listed. In some cases, manufacturing-related markings may be difficult to distinguish from retailer or importer markings.

The 'make' of the weapon is generally analogous to a weapon's 'brand', and is typically marked on the weapon. In some cases, the weapon will be marked with the 'make' rather than 'manufacturer'.⁶⁸ Image 3.42 shows a Russian Baikal self-loading shotgun marked with the make (Baikal). The manufacturer of this weapon is Concern Kalashnikov (not marked), which produces three brands of weapons at two major manufacturing plants. The 'manufacturer' of a weapon is the entity that actually produces that weapon. Make and manufacturer are often confused. A simple rule to remember is that what is marked on the weapon can generally be considered its make. This may also be the manufacturer (see Image 3.43). If a manufacturer or 'make' marking is consistent with the overall physical features of a weapon, a tentative identification is relatively easy to establish.

⁶⁸ This is sometimes the case when weapons are produced under a 'white label' approach, where subsequent sellers will mark the weapon as if they produced it.

Image 3.42 Make marking on a Russian MP-155 self-loading shotgun



Note: The make, 'Baikal', is marked clearly on the gun.

Source: Concern Kalashnikov

Image 3.43 Make and manufacturer markings on a Belgian FN Herstal SCAR-H self-loading rifle



Note: See the FN Herstal logo at bottom, and 'FN HERSTAL BELGIUM' at top.

Source: N.R. Jenzen-Jones/ARES

Country markings take the form of the name of the country of origin, a national coat of arms, a crest, or other symbol (see Image 3.44). Typically, these markings appear in an indigenous or official language of the country in which the weapons are manufactured, but in some cases the language is that of the country of service (for example, for foreign contracts) (see Image 3.45; Box 3.7). In some cases, country markings may narrow the possible years of production. For example, weapons marked 'Yugoslavia' were produced when Yugoslavia was a recognized state (between 1929 and 2003). Country of origin may also be indicated by proof marks (see below).

Image 3.44 Country marking on a Yugoslavian Zastava Arms M48A bolt-action rifle



Note: The marking shows the Federal People's Republic of Yugoslavia crest.

Source: N.R. Jenzen-Jones/ARES

Image 3.45 A Russian Mosin Nagant rifle marked on the top of the receiver in Russian (Cyrillic script), but manufactured in Châtelleraut, France



Source: McCollum (2014b)

Box 3.7 State participation in the small arms and light weapons supply chain

State facilities (also known as ‘arsenals’ or ‘armouries’) are often involved in the small arms and light weapons supply chain. Some only manufacture weapons or only store them, while others perform both functions, occasionally leading to confusion over the actual place of manufacture. These facilities may also repair, refurbish, maintain, or issue weapons. Some facilities assemble weapons from prefabricated parts, even when they have the capability to build from scratch different models of firearms, while other facilities manufacture some components and import others (for example, facilities in Saudi Arabia and Egypt) (Gaub and Stanley-Lockman, 2017). Increasingly, manufacturers of small arms and light weapons are international corporations with subsidiaries and facilities in more than one country. Weapon designs may also be licensed for production by other companies around the world (Jenzen-Jones, 2017d).⁶⁹ Because of this range of possibilities, it is important to document all markings wherever possible, and as accurately as possible, to allow for the potential revision of an identification in light of new information.

Model and calibre designations

Model designations are another important source of information. Many small arms, whether military or commercial, are marked with a model and iterative variant designation. For example, the designation ‘L85A2’ refers to an updated ‘A2’ variant of the British L85 rifle (Ferguson, 2017c). This is not always the case and varies by country and/or manufacturer; Russian AK- and AKM-pattern rifles, for example, are generally not marked in this way. While some variants of a weapon bear the same model designations, other close or exact copies are marked very differently. Some militaries assign their own designations to weapons, some of which differ significantly from the designation assigned by the designer or manufacturer. For example, the Barrett M82A1M anti-materiel rifle was adopted by the US Army as the M107. Barrett later produced a product called the M107A1, to position the rifle as the successor to the M107 (Choat, 2012; Vining, 2016).

Some companies also assign different designations to the same model of weapon. For example, the Heckler & Koch pistol marked as the VP9 in the United States is marked ‘SFP9’ in Europe.⁷⁰ Furthermore, model and calibre designations may be added by importers, assemblers, and other parties after manufacture. In some cases, the importer’s or assembler’s markings are not technically correct. For example, many of the AK-type rifles imported into the United States are erroneously

69 For a more detailed discussion of the licensed and unlicensed production of small arms, see Jenzen-Jones (2017d, pp. 33–38).

70 As seen on Heckler & Koch’s US and European websites in late 2017.

Image 3.46 Model and calibre markings on a German Heckler & Koch HK416D self-loading rifle

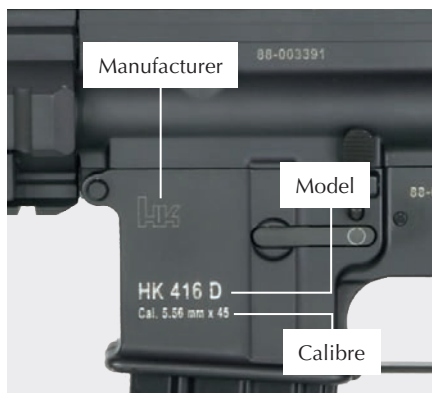

Note: The model reads 'HK416D' and the calibre is marked as 'Cal. 5.56 mm × 45'.

Source: N.R. Jenzen-Jones/ARES

ly marked as 'AK-47' rifles. Not only are these rifles not technically 'AK-47' models, but most were not even made in Russia or Bulgaria.⁷¹

While somewhat less useful than other markings, calibre designations can also help distinguish many similar models of firearms. Many weapons are offered by manufacturers in a range of calibres. For example, the Remington Model 700 bolt-action rifle has been produced in more than 15 calibres and has been converted by independent gunsmiths to other calibres (Lacy, 1989; van Zwoll, 2014). Calibre designations may be rendered in imperial or metric

units, and may use either the decimal point or decimal comma. Of course, they may also be marked using non-English scripts or conventions. Ideally the full calibre (for example, 7.62 × 39 mm) will appear, but it is also common to find the less helpful bore/bullet diameter only (for example, 7.62 mm). Model and calibre designations often appear together (see Images 3.46 and 3.47).

In the case of shotguns and muzzle-loading weapons, the gauge or 'bore' of the gun will typically appear, often along with proof marks, on the underside of the barrel. Viewing these markings may require the disassembly of the weapon.

It is important to note that sometimes the calibre of the weapon and the calibre designation do not match. When gunsmiths change the calibre of a weapon, they should also re-mark it with the new calibre designation, but this does not always happen. Therefore, it may be necessary to test-fit a cartridge (or fired cartridge case) into a weapon or obtain a chamber cast to determine the correct calibre (see Image 3.48).⁷²

⁷¹ See, for example, Images 3.47c and 3.60.

⁷² See, for example, Ferguson (2017a). The test-fitted cartridge should ideally be a dummy cartridge (see Chapter 4). You should not place a live cartridge into the action of any firearm if you do not have the appropriate safety and handling training.

Image 3.47 Examples of model and calibre markings



Note: (a) Markings ('Tabuk' and 'Cal. 7.62×39mm') on the right side of the rear sight block of an Iraqi Tabuk self-loading rifle. (b) Markings ('CQ' and 'CAL. 5.56MM') on a Chinese CQ self-loading rifle. (c) Markings ('WASR 10/63' and 'Cal. 7.62×39mm') on a Romanian GP WASR 10/63 semi-automatic rifle, rebuilt to Pistol Mitralieră md. 1963 standard. These are post-production markings engraved by an importer.

Sources: C.J. Chivers/*The New York Times*; Bradley E. Owen/Osprey Security Services via ARES; N.R. Jenzen-Jones/ARES

Image 3.48 A rifle with a calibre marking on the top surface of the receiver



Note: The marking reads simply '7 M M'. After a chamber cast and test-fitting of a dummy cartridge, it was determined to be chambered for 7 mm Mauser (7 × 57 mm).

Source: Ferguson (2017a)

Serial numbers and date markings

Serial numbers have been in use for at least 150 years, and were first marked by manufacturers for their own accounting and marketing purposes (ARES, 2017). Today most serial numbers are engraved, cast, or stamped onto firearms by producers as a way of tracing, dating, and identifying the weapon (see Images 3.49–3.53). They are most often an alphanumeric code, and sometimes incorporate factory, model, or year designations. Manufacture dates are routinely stamped adjacent to the true serial number on some firearms, such as certain AK-type rifles (see below).

Serial numbers are useful for tracing weapons when they are recorded in documentation pertaining to manufacture, import, export, licensing, or in-country transfer. Due to national and international legal requirements, a primary serial number is usually marked on a firearm or light weapon's main assembly (nearly always the receiver/frame), though the precise location of the number varies between weapons (Ferguson, Jenzen-Jones, and McCollum, 2014; Jenzen-Jones and McCollum, 2016). The simplest serial numbers are single, 'rolling' numbers for a given model or variant. Serial numbers for mass-produced arms run into the millions. However, manufacturers frequently use more than one range of serial numbers in certain cases, including when:

- serial numbers become excessively long;
- weapons are exported to a particular country or customer;
- a new variant of the weapon is introduced; or
- a new factory is brought online.

Typically, a prefix and/or suffix will be applied to the serial number to differentiate a new range of serial numbers from the old range. Some firearms are assigned multiple serial numbers by the same factory. Generally, one of these numbers can be conceived of as the 'master' number, used by the factory to uniquely identify the weapon, and track overall production. One or more other serial numbers may also be applied, commonly representing other metrics, such as the number of the weapon within a production run. This practice is uncommon but awareness of it is essential when tracing some firearms, such as the Belgian-made FN Herstal FAL self-loading rifle (Jenzen-Jones and Spleeters, 2015). Firearms may also receive an alternative or additional serial number as part of the importation process, when a weapon has been rebuilt or built from parts by a party other than the original parts' manufacturer(s), or when national or regional marking practices are applied. Other circumstances in which weapons receive new serial numbers include when the original serial number is illegible due to wear or defacement, or when the manufacturer used foreign alphabets or numerals.

Image 3.49 Serial number marking on a Russian AK-103-2 self-loading rifle



Note: The serial number is '071464557'. This self-loading rifle was produced by IZHMAASH.

Source: ARES (n.d.)

Image 3.50 Part-serial number (3042) stamped on a recoil spring guide assembly from a Polish kbk AKMS self-loading rifle



Note: This is the same weapon as shown in Image 3.40a; note the repetition of the last digits of the serial number.
Source: ARES (n.d.)

The serial number is usually duplicated on the bolt and/or bolt carrier carrier and the barrel, partly because these components may themselves be subject to legal control, but also to keep the originally manufactured parts together for best fit and function. In addition, serial numbers are often partially or fully stamped on other components of the weapon, including, in rare cases, on individual pins, screws, and springs. Small parts are often marked with only the last few digits of the full serial number (see Image 3.50).

Given that most small arms have interchangeable parts, serial numbers on different parts of a weapon sometimes do not correspond, especially when the weapon has seen extensive use. The weapon may have been initially assembled from a collection of parts of different provenance, or it may contain replacement parts. In the case of AK-type weapons, for example, it is often so easy to interchange parts that a weapon may include components made in a different country, for a wholly different model or variant. Parts may even have been produced decades before or after the host weapon was manufactured. It is also possible that

Image 3.51 Serial number (88-003391) on a German Heckler & Koch HK416D self-loading rifle



Source: N.R. Jenzen-Jones/ARES

Image 3.52 Serial number (BI1229) and year marking (1956) on a Romanian TTC self-loading pistol



Source: N.R. Jenzen-Jones/ARES

markings on various components may not in fact be serial numbers at all: components in some vintage firearms are marked with assembly numbers, for example (ARES, 2017; Ferguson, Jenzen-Jones, and McCollum, 2014).

In some cases, replacement or interchangeable components issued with a weapon (such as spare machine gun barrels, or calibre-change kits for so-called modular weapons) may feature partial or complete serial numbers, which may confuse investigators in the field. Beretta ARX-160 self-loading rifles, for example, sometimes feature multiple barrels marked with the full serial number of the 'parent' weapon. This makes it difficult to determine whether a given barrel is a primary or secondary configuration, and also presents cataloguing and tracing problems. On the other hand, both Heckler & Koch (HK) and FN Herstal (FNH) 'sub-number' additional components, featuring the serial number as marked on the parent weapon followed by either a forward slash (HK) or hyphen (FNH), then a sequential number. Two barrels for hypothetical gun number 12345 might thus be marked '12345/1' or '12345-1' and '12345/2' or '12345-2' (Ferguson, Jenzen-Jones, and McCollum, 2014).

Some criminals and armed groups deliberately attempt to remove serial numbers with the goal of preventing authorities from tracing weapons to their source. It may be possible to recover markings that are ground or filed off (Rowe, 2015).

Image 3.53 Post-production serial number (B-252) on a German Heckler & Koch G36V self-loading rifle



Note: The original serial number has been abraded and a new marking engraved.

Source: Damien Spleeters

It is also important to note that while removing serial numbers and other key markings may impede a tracing attempt, it does not mean that the firearms cannot be uniquely identified. Experts use different forensic and close inspection techniques to identify a specific weapon, even in the absence of serial numbers.

Marks which appear similar to serial numbers are sometimes applied by importers, assemblers, or other parties after the weapon is manufactured. Military, law enforcement, and armed groups often apply 'rack numbers' (a basic form of registration) to weapons (see 'Import and other markings', below). These numbers are often mistaken for serial numbers or other markings. For these reasons, serial numbers should be interpreted in conjunction with an analysis of the type and make or manufacturer of the weapon in question.

Serial numbers are also frequently useful in identifying the manufacture date of a firearm. Some firearm serial numbers incorporate an alphanumeric code that can be translated into a date (most commonly a year) of manufacture. For example, a Browning Hi Power pistol made in 1969 would have the serial number

Image 3.54 Examples of date markings



Note: (a) German Walther PPS self-loading pistol marked (left to right) DE for Germany; eagle over 'N' for definitive smokeless proof (repeated along with manufacturer and calibre marks on the barrel); date code 'AI' for 08 (proof year 2008); and the deer antler proof mark of the Beschussamt Ulm C.I.P. accredited Proof House. Note also the safety warning. (b) Year marking ('1954') on a Russian Tula APS automatic pistol. Note also the safety/selector markings (IIP, OZ, ABT) and manufacturer marking (star-in-shield for Tula). (c) Date markings on an American Colt Model 1911A1 self-loading pistol. Various date markings have been stamped into the slide, but none of these markings indicate the year of manufacture of this example.

Sources: Wikimedia Commons/Praiychat; N.R. Jenzen-Jones/ARES; Bear Arms Firearms Reference Collection via ARES

69C1000, denoting the one thousandth Hi Power pistol (indicated by the letter C) produced in 1969 (Browning, n.d.). Not all cases are this straightforward. Often, identifying and deciphering dates in serial numbers requires the assistance of specialists. In other cases, a simple methodology relying on known cumulative production data for a given period can be developed.⁷³

Date markings often reflect the year of manufacture, but this is not always the case, particularly on older military firearms. In some cases, these markings instead indicate:

- the date of factory repair or refurbishment;
- the date of adoption by an armed force;
- the official or unofficial model designation;
- the import date; or
- the patent date.

For example, different models and variants of the Colt M1911 pistol feature both a model number that represents a year of military adoption (1911) and several dates in which the manufacturer received patents (for example 1897, 1902, 1905, etc.) (see Image 3.54c) (Lisker, 2018). Dates may appear numerically in two- or four-digit form ('85' or '1985'), or as an alphabetical or alphanumeric code, in which case dating the weapon is often difficult or impossible without the manufacturer's cooperation or authoritative reference material. The location of date markings also varies. Some are placed in a separate location from other markings, while others are applied next to the serial number, or are an actual component of the serial number.

Selector, sight, and safety markings

Markings on fire selectors, safety 'catches', and sights also provide clues regarding the origin and model of some firearms. For example, many semi-automatic models of a given weapon can be quickly distinguished from their selective-fire counterparts by examining the fire selector. Lettering or symbols used to mark fire selector and safety positions and sight increments, particularly the default setting on many weapons (often called the 'zero' or 'battle sight' position), are sometimes indicative of a specific country of origin, or make or manufacturer.

73 For an example of such a methodology and how it can be applied to arms tracing, see Jenzen-Jones and Elliott (2015).

Image 3.55 Examples of safety/selector markings



Note: (a) Markings (S, 1, A) on a Belgian FN Herstal SCAR-L self-loading rifle. (b) Pictographic markings on a German Heckler & Koch MP7 SMG. (c) Markings (D, E) on an East German MPI-KM self-loading rifle. (d) Markings (SAFE, SEMI, AUTO) on a British LANTAC LA-M4 self-loading rifle.

Sources: ARES (n.d.); N.R. Jenzen-Jones/ARES

Selector markings consist of some combination of words, letters, numbers, or symbols representing different settings for firearms. These settings are 'safety', 'semi-automatic', 'automatic', and sometimes 'burst fire'.⁷⁴ The use of English is common, and some variation on either the US 'safe, semi-automatic, automatic' (sometimes acronymized as 'S,S,A' or 'S,1,A'; see Images 3.55a, d), or the British 'automatic, repetition, safe' ('A,R,S'), is often encountered. Markings may directly represent English words, foreign language words (for example 'E' and 'D' for

⁷⁴ The term 'burst fire' refers to a firing cycle that restricts an automatic weapon to firing a fixed number of rounds (typically two or three) for each press of the trigger (ARES, 2017).

'Einzelfeuer' and 'Dauerfeuer' on some German weapons, as shown in Image 3.55c) or, as in the case of some Chinese Type 56 rifles, transliterated words ('L' and 'D' for 'Liàn' and 'Dán') (Andrew, 2015; McCollum, Stott and Vickers, 2018). Pictographic fire selector/safety markings are increasingly common (see Image 3.55b).

Some weapons may have special sights for launching rifle grenades, which are often referred to as auxiliary folding leaf sights, or simply 'leaf sights' (Image 3.56b). Markings on these sights are often informative and should be recorded, when possible.

Although selector markings may be altered, and sights may be replaced entirely, experience in the field suggests that this is rarely done. However, as in all aspects, care must be taken to assess all physical features and markings, both individually and together.

Image 3.56 Examples of sight markings

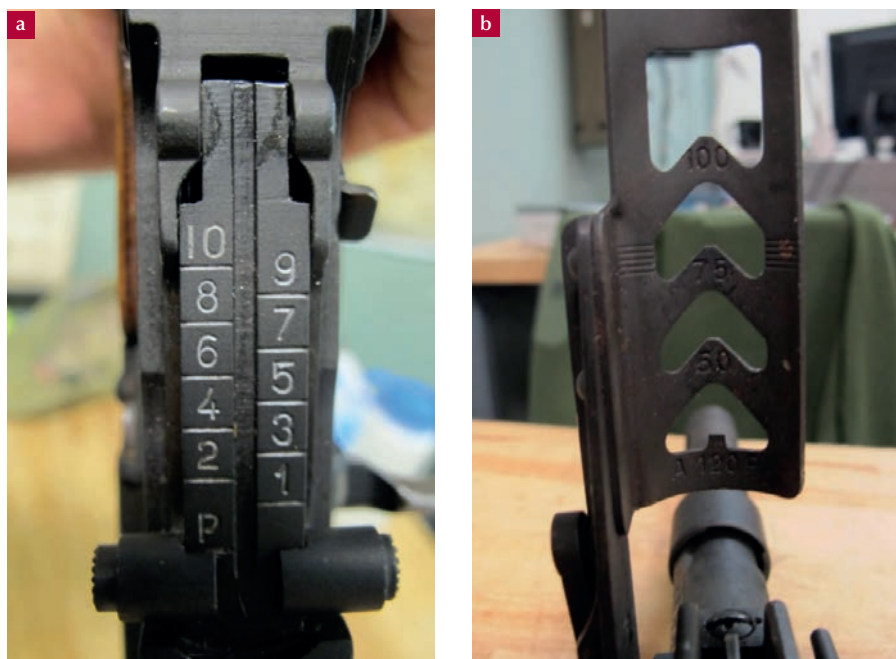

Note: (a) Rear sight markings on the adjustable rear sight of a Romanian Pistol Mitralieră md. 1963 self-loading rifle. A 'P' appears in place of zero, in bottom left position. (b) Markings on a folding rifle grenade leaf sight on a French MAS Modèle 1936-51 bolt-action rifle.

Source: N.R. Jenzen-Jones/ARES

Proof, inspection, and acceptance marks

Proof marks and inspection marks are applied to firearms and parts to show that they comply with safety standards and meet national expectations regarding quality (see Image 3.57).⁷⁵ Not all countries require a weapon to undergo proof; it is not a legal requirement for sale in the United States, for example. Today, proof marks from one country are often recognized by other countries and therefore firearms are less likely to be proofed by multiple government agencies. Where multiple sets of marks from different jurisdictions are present, however, the marks provide useful historical information about the firearm in question (McCollum, 2014b; Wirnsberger, 1985).

Proof marks can be used to trace weapons or components to certain countries, and may also assist in narrowing down a production timeframe. Markings that include a date code allow for precise dating, but changes to the form and method of application of other marks may also provide clues regarding the manufacture date. For example, slight variations in symbols, letters, and placement may indicate the period in which a weapon was proofed. In some cases, especially with marks applied by certain manufacturers in the United States, proof marks can

Image 3.57 Examples of proof and inspection markings

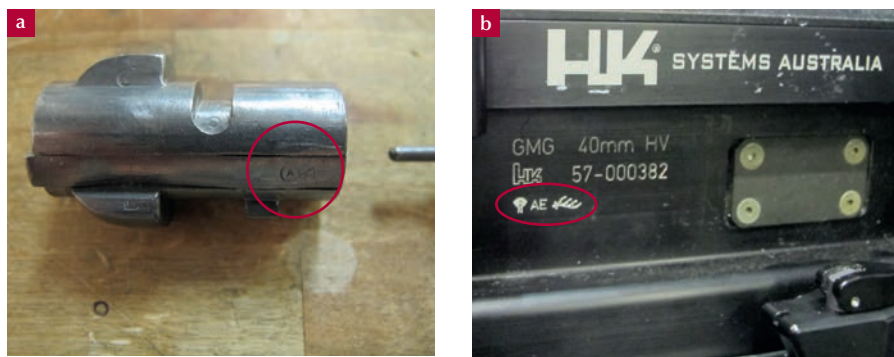

Note: (a) Proof marks on the bolt head of a Russian Mosin-Nagant Model 1891/30 bolt-action rifle. (b) Proof and inspection marks on a German Heckler & Koch grenade machine gun.

Source: N.R. Jenzen-Jones/ARES

⁷⁵ These inspections often consist of firing special proof cartridges, which generate substantially increased peak chamber pressure, to ensure that a barrel and bolt will sustain repeated firings under conditions of normal use. Proof marks are generally underwritten by government entities in countries with a history of proofing, including many in Europe (Wirnsberger, 1985).

Image 3.58 Inspection marking on an M16 barrel



Note: The 'C' indicates the barrel was produced by Colt, 'MP' shows the barrel underwent a magnetic particle inspection, '5.56 NATO' indicates the barrel calibre, and '1/7' indicates the twist rate of the barrel's rifling.

Source: Bear Arms Firearms Reference Collection via ARES

even indicate the manufacturer or factory of production. Some proof marks are self-explanatory, but interpreting others requires the assistance of a specialist.⁷⁶

Inspection marks are often confused with proof marks, and indeed some are applied by a proof house.⁷⁷ However, most inspection marks are applied at the factory where the weapon is manufactured, and relate to standards of fit, finish, and overall quality (hence 'inspection'). Each inspector is typically assigned a coded mark, which allows for the identification of the factory and responsible inspector of any weapons with quality or safety issues. Inspection marks are sometimes useful in identifying or confirming the manufacture date of components that are either detached or part of a rebuilt weapon. They are also occasionally used to identify weapons with obscured or obliterated make or model marks, serial numbers, etc.

Military organizations may subject their arms to tests that result in additional inspection markings, such as the 'MP' found on US military small arms barrels.⁷⁸ This indicates the barrel underwent magnetic particle inspection, a test of the barrel's integrity distinct from—and additional to—the traditional proof test (see Image 3.58) (ARDC, 1968).

Finally, acceptance marks and ownership marks are sometimes found on individual small arms and denote official government ownership of the item. The

⁷⁶ See, for example, Wirnsberger (1985).

⁷⁷ Examples include the coded inspector's marks used at the Belgian proof house in Liège (Wirnsberger, 1985).

⁷⁸ These tests are now also performed on some commercial barrels.

Image 3.59 Examples of government property and arsenal markings



Note: (a) Government property markings on American Hydra-Matic M16A1. Note also the make/manufacturer, country of origin, calibre, and serial number markings. (b) Arsenal mark on an Iraqi Tabuk self-loading rifle.

Sources: N.R. Jenzen-Jones/ARES; C.J. Chivers/*The New York Times*

US military, for example, initially used an image of a flaming bomb, which was the symbol of the Ordnance Department. This symbol was eventually replaced by the straightforward ‘PROPERTY OF U.S. GOVT.’ (see Image 3.59a).

Import and other markings

Many other types of markings are applied to small arms and light weapons, in various locations. They are applied by manufacturers, importers, end users, and other parties in the chain of custody.

Import markings are applied by exporters or importers, usually to comply with legislation in the destination country. US regulations for marking imported firearms are among the most influential. Because of the United States’ position as the largest commercial market for modern small arms, many manufacturers have aligned their marking practices to US standards (Jenzen-Jones and McCollum, 2016). The US government requires that the following elements be conspicuously marked on any firearms imported into the United States (ATF, 2016):⁷⁹

- Serial number
- Name of manufacturer
- Country of origin
- Model designation
- Calibre or gauge
- Name of importer
- City and state of importer

⁷⁹ Specifically, ‘conspicuously engraved, cast or stamped (impressed)’ (ATF, 2016).

Image 3.60 Import markings on a Polish kbk AKM self-loading rifle imported into the United States



Note: The markings are located below the serial number ('KW10184') and incorrectly identify the rifle model as an 'AK47'.
Source: N.R. Jenzen-Jones/ARES

Many national laws and multilateral instruments require that manufacturers of small arms adhere to stringent marking practices at the time a weapon is produced. Import marks are often applied in a different fashion to original markings, sometimes resulting in tell-tale bright metal markings. Image 3.60 shows the markings on a rifle destined for a US importer (Jenzen-Jones and McCollum, 2016).

Military arms may feature unit markings, or 'rack numbers', generally assigned for inventory control and auditing purposes. Traditionally these markings were inscribed into the weapon, and may easily be mistaken for serial numbers at first glance. Today, many unit markings are often much easier to distinguish from serial numbers. They are often printed on barcode stickers or QR-style decals (see Image 3.61a). Some markings are simply painted on to the butt-stock (Image 3.61b).

Image 3.61 Examples of inventory markings

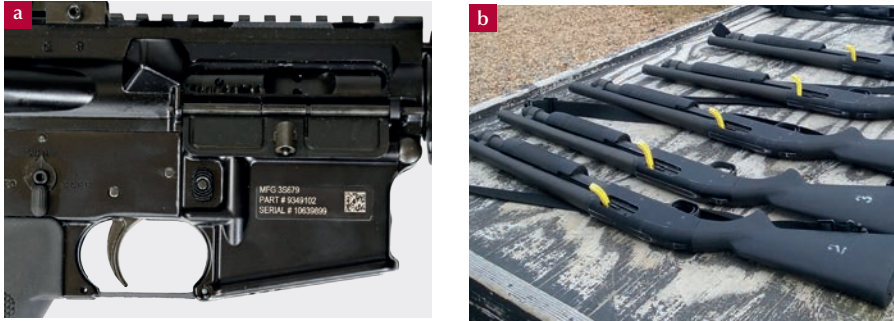

Note: (a) Inventory markings and QR code on a US military M4A1 self-loading rifle. (b) Painted 'rack number' markings on US Navy Mossberg 500 series pump-action shotguns.
Sources: US Army; Brendan Mooney

Other markings sometimes found on firearms include safety warnings and patent markings, which may prove useful identifiers (Image 3.62).⁸⁰ When documenting arms, a thorough visual inspection should be conducted to ensure that such markings are not overlooked.

Feed devices

Feed devices are often found in the field or at crime scenes, either attached to a weapon or in isolation. Feed devices, in this context, include removable magazines, drums, belts (and individual belt links), and chargers (stripper clips). These items should be examined for markings, such as those seen in Images 3.63–3.65. It is important to record whether feed devices were found loaded into a weapon, alongside it, or in isolation. If feed devices are loaded, the cartridges should be documented if possible.⁸¹

Image 3.62 Patent markings on German Heckler & Koch USP



Source: N.R. Jenzen-Jones/ARES

⁸⁰ See an example of a safety warning in Image 3.54a.

⁸¹ See Chapter 4 for information on recording small-calibre ammunition characteristics.

Image 3.63 Manufacturer markings on magazines

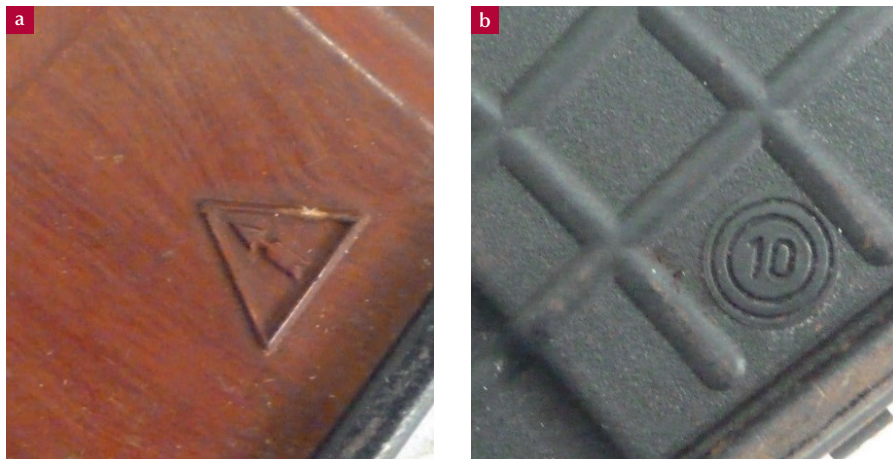

Note: (a) IZHMAISH and (b) Arsenal JSCo markings on Russian and Bulgarian AK-pattern 7.62 × 39 mm magazines, respectively.

Source: Holger Anders

Image 3.64 Partial serial number stamped on the bottom of a Romanian TTC 7.62 × 25 mm magazine



Source: N.R. Jenzen-Jones/ARES

Image 3.65 Different manufacturer markings on three detachable box magazines for the Danish Hovea m/49 SMG



Note: These magazines show different construction techniques, metal finishes, and fonts used for the marking '36'.

Source: N.R. Jenzen-Jones/ARES

Packaging and documentation

Many small arms are observed in the field with packaging and, less frequently, documentation. There are two types of packaging: outer packaging and inner packaging. Outer packaging most often consists of wooden shipping crates. Inner packaging includes weapon cases, plastic packaging, moulded foams, and some form of paper. Packaging can provide valuable clues as to the origin, place of production, age, type, and destination of the arms in question. It may also reveal information regarding ports of transit, dates of transfer, and other important details (see Images 3.66, 3.67).

Some packaging is marked in a misleading or covert fashion. Crates of weapons exported from North Korea, for example, are often intentionally mislabelled with phrases such as 'Parts of rock drill' and 'Parts of tractor' (Jenzen-Jones and Noakes, forthcoming; see Image 3.68).

Image 3.66 Markings on an external packaging



Note: While the model(s) contained within are not listed on this face of the shipping crate, there is a lot of very valuable information contained in the image.

Source: Confidential/ARES

Image 3.67 Packaging crate from Belgian weapons documented in Libya

Source: Confidential/ARES

Image 3.68 Markings on a crate delivered to Qaddafi-era Libya from North Korea

Note: Markings in the top right-hand image indicate that the crate contained 'Parts of bulldozer', when in fact contained a 122 mm high-explosive fragmentation (HE-FRAG) artillery rocket. Small arms are also sometimes packaged in a similar fashion.

Source: Confidential/ARES

Documentation can be one of the best sources of information about individual weapons and arms flows (see Chapters 8 and 9). Documentation on exports, imports, and in-country transfers often sheds more light on the scale, nature, and timing of shipments than the arms themselves. These documents often include contract dates, order quantities, ports of transfer, and the country of origin (see Image 3.69). Such documents may also contain the names and signatures of individuals involved in arms transfers—key evidence in certain types of investigations. Documents are often found inside packaging, but are also sometimes encountered in other locations, such as when filed in armouries or depots. Wherever possible, the authenticity of the documents should be confirmed by comparing them to verified originals of the same types of documents.

Ancillaries and accessories

Small arms are often found with ancillaries and accessories. Ancillaries are items commonly provided with a weapon, including slings, cleaning kits, and oil bottles. Accessories, which are sometimes called ‘auxiliary’ items or ‘attachments’, are devices that increase the effectiveness or usefulness of a weapon but, generally speaking, are not essential for its basic, intended use (Grzybowski, Marsh, and Schroeder, 2012, p. 245). Some accessories, such as under-barrel grenade launchers, are themselves weapons. Other examples include:

- sound suppressors;⁸²
- optical sights (‘optics’);
- fore-grips; and
- flashlights.

Accessories are increasingly found outside military and law enforcement spheres due to the proliferation of—and apparent prestige afforded by—the rails on which many accessories are mounted.

Ancillaries and accessories sometimes provide clues as to the origins of the weapons to which they are attached. Some of these items are also indicators of state or government support. Accessories generally have their own markings, similar to those found on arms (see Image 3.70). These markings should be carefully documented.

82 Sound suppressors are distinct from muzzle attachments by virtue of being typically readily detachable and not usually supplied with a firearm.

Image 3.69 Delivery documentation (packing list) for Russian AK-103-2 self-loading rifles delivered to Libya

1003002 5

УПАКОВОЧНЫЙ ЛИСТ
PACKING LIST №34/1/IZ/ 1745

Экспортёр
Exporter: ФГУП "Рособоронэкспорт"
FSUE "Rosoboronekspert"

Экспортёр
Contract No. 27/2004/P/343406131003 of 19.04.2004

Заказ-наряд №
Order-parjad No. P/343406131003-411443 of 06.09.2004

Грузополучатель
Consignee: ДЕПАРТАМЕНТ ЗАКУПОК ТРИПОЛИ, ЛИВИЯ
PROCUREMENT DEPARTMENT TRIPOLI, LIBYA

Лист 1
Sheet

Листов 1
Sheets

Order number and date

Метки в номерах Marks and numbers	Наименование товара Description of goods	Ед. изм. Unit of measurement	Количество товара Quantity	Масса, кг брутто/ нетто Mass, kg gross/net	Вид груз. мест Type of packages	Номер места Package Nos
1.	7,62 мм автомат Калашникова АК-103-2 (индекс 6I45.C6-02) 7,62-mm Kalashnikov assault rifle AK-103-2 (index 6I45.C6-02) No. 041368039 051372027 041379933 051374881 051362370 051387826 051364678 051383287 051366720 051382218 051373429 051384479	796 шт. pcs	12	90/59	812 ящик case	b/ c/ d
	Магазин под патрон 7,62x39 Magazine to 7,62x39 cartridge	шт.	48			
	Плтык-нож в сборе Knife- bayonet assembly	шт.	12			
	Шомпол Cleaning rod	шт.	12			
	Принадлежность в пенале (пенала в сборе, протирка, отвертка, выколотка, вртш в сборе) Accessory in the container (container assembly, pull-through, screwdriver, drift, brush assembly)	шт.	12			
	Ремень для ношения стрелкового оружия Sling for carrying small arms	шт.	12			
	Масленка Oiler	шт.	12			

Serial numbers of rifles

Exported items

Quantity of exported items

Marking:
EXPORT
Contract No 27/2004/P/343406131003
Port of loading: Oktyabrsk, CIS Port
Port of destination: Tripoli Libya
Supplier: FSUE "Rosoboronekspert"
Customer: Procurement Department Tripoli Libya
Shipment Lot No: 1/IZ
Case No: 1745/5003/5003
Gross weight /net weight, 90/59 kg
Goods contract index: 343406131003-01

PACKING LIST №34/1/IZ /b
(434 - Consignee's country code, approved in Russia,
1 - number of the item acc to the Appendix No 1 to the Contract,
1 - No of the Exporter's shipment Lot,
IZ - indication of the manufacturer
b - packages No of the manufacturer Lot)
Shipment Lot No: 1/IZ
(1 - No of the Exporter's shipment Lot
IZ - indication of the manufacturer), Concern "Izhmash" JSC
Case No: b/c/d
(b - packages No of the manufacturer Lot,
c - total quantity of the packages in the manufacturer Lot,
d - total quantity of this manufacturer's packages which have been delivered to the Consignee, taking into account this Lot of the manufacturer's equipment)

Подпись
Signature: [Signature]

Дата
Date: 05 04 05

Signatures and inspectors' stamps

Packaging markings

Date of packing list

Source: Jenzen-Jones (2016c)

Image 3.70 Markings on a German Heckler & Koch AG SA 80 (L17A2) 40 × 46 SR mm under-barrel grenade launcher attached to an L85 series self-loading rifle



Source: N.R. Jenzen-Jones/ARES

— **Authors: N.R. Jenzen-Jones with Jonathan Ferguson**

CHAPTER 4

Weapons Identification: Small-calibre Ammunition

Introduction

Ammunition for small arms is frequently encountered in conflict zones, but is often overlooked despite its importance to the arms and ammunition identification process. While firearms are durable goods, and can last for decades, ammunition is a consumable, and supplies must be periodically replenished. As such, ammunition plays a decisive role in escalating, prolonging, and intensifying armed conflict (Greene, 2006).

Small-calibre ammunition (less than 20 mm) is used primarily with small arms, although it is also in use with some light weapons (most notably heavy machine guns). This chapter provides an overview of small-calibre ammunition and how to identify it by looking at its physical characteristics, markings, and packaging.

Small-calibre ammunition: an overview

The vast majority of modern small arms use cartridges as ammunition. In the field of small-calibre ammunition, the terms ‘cartridge’ and ‘round’ are synonymous: both refer to a single complete unit of ammunition. Modern small-calibre cartridges are generally comprised of:

1. A **projectile**, or bullet, which is fired from the gun. It typically consists of a ‘core’ and ‘jacket’.
2. **Propellant**, which, when ignited, generates the gas pressure that propels the projectile out of the barrel.
3. A **primer**, which contains chemical compounds designed to be ignited by a firing pin. The primer then, in turn, ignites the propellant.
4. A **cartridge case**, which contains the components of a complete round of ammunition and, when the weapon is fired, blocks the escape of gases in a way that causes pressure to build up behind the projectile (Goad and Halsey, 1982; Jenzen-Jones, 2016a, p. 13).⁸³

Figure 4.1 shows the component parts of a typical small-calibre cartridge.

During the first half of the 20th century, most global militaries had a single cartridge, typically a so-called ‘full-power’ round in the 7.5 to 8 mm range.⁸⁴ These

83 An exception is caseless ammunition.

84 Some nations, however, adopted cartridges in the 6.5 mm range. These nations later adopted supplementary cartridges in the range of 7.7 to 8 mm (Williams, 2015).

Figure 4.1 Cross-section of a 7.62 × 51 mm cartridge

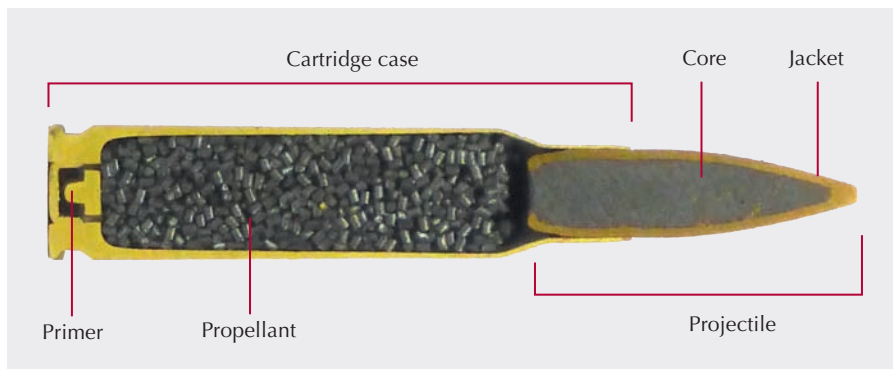

Source: Anthony G. Williams/ARES

rounds were used both in the standard bolt-action rifles of the time and in machine guns. During the Second World War, the German military introduced the first of a series of so-called 'intermediate-calibre' cartridges; that is, cartridges that are intermediate in size, weight, and power, between those fired by handguns and SMGs, and those fired by 'full-power' rifles. The most influential intermediate-calibre round is the 7.62 × 39 mm cartridge, which was adopted in 1943 and widely used in the ubiquitous SKS and AK series of self-loading rifles (Jenzen-Jones, 2016a; Ponomarev, 2004).

In the early 1960s, the United States adopted the 5.56 × 45 mm cartridge, which was the first small-calibre, high-velocity (SCHV) round to be widely issued for military service. SCHV rounds have a longer effective range and weigh less than previous small-calibre rounds. The cartridge was adopted in conjunction with the AR-15 (designated as the M16 in US military service), and was a commercial and military success; at least 16 million AR-15-type rifles had been produced by late 2015 (Jenzen-Jones, 2017d; Williams, 2015).

In 1980, NATO accepted the 5.56 × 45 mm cartridge as a standard cartridge, alongside the 7.62 × 51 mm round. Today, the 5.56 × 45 mm cartridge is in service with numerous NATO and non-NATO states (Johnston and Nelson, 2010; Rottman, 2011). In the mid-1970s, the Soviet military also adopted a SCHV round, the 5.45 × 39 mm cartridge, which became standard issue. Nonetheless, the 5.56 × 45 mm and 7.62 × 39 mm cartridges remain the predominant military rifle cartridges in service globally (ARES, 2015a).

Despite the widespread adoption of intermediate and SCHV cartridges, full-power rifle cartridges remain in military service (ARES, 2016a). Most of the world's armies now employ a two-calibre system for primary infantry arms (generally rifles and machine guns). A full-power rifle cartridge is generally employed with general-purpose machine guns and specialized precision rifles, while an intermediate or SCHV cartridge is employed with standard service rifles and light machine guns (Jenzen-Jones, 2017d).

In NATO and allied nations, these two calibres are the 5.56×45 mm and 7.62×51 mm cartridges. Former Warsaw Pact states have a history of employing the 7.62×39 mm and $7.62 \times 54R$ mm cartridges, although some countries have since replaced or supplemented the former with the 5.45×39 mm cartridge. China relied on the standard Warsaw Pact cartridges before supplementing these with their own 5.8×42 mm cartridge in 1995 (Andrew, 2015; Williams, 2015). These calibres are described in Table 4.1 and illustrated in Image 4.1.

Recent trends in design and development reveal increasing interest in a so-called 'general-purpose' calibre, which is intended as a single calibre to replace the current two-calibre system. To date, however, no major military has transitioned to a general-purpose calibre (Jenzen-Jones, 2017d).

Handgun-calibre cartridges are significantly less powerful than rifle-calibre ammunition and require a shorter barrel to achieve their optimum performance.

Table 4.1 Dominant rifle and machine gun cartridges in global military service

Cartridge designation	Country of origin	Total weight (g)*	Bullet weight (g)*	Muzzle velocity (m/s)*	Muzzle energy (J)*
$7.62 \times 54R$ mm	Russian Empire	24.0	9.5	845	3,400
7.62×51 mm	United States	24.0	9.5	838	3,340
7.62×39 mm	Soviet Union	16.5	7.9	715	2,020
5.8×42 mm	China (PRC)	12.8	4.6	790–970	1,920
5.56×45 mm	United States	12.0	4.0	875–950	1,530–1,800
5.45×39 mm	Soviet Union	10.5	3.4	900	1,417

Note: All figures are approximations and vary according to barrel length, cartridge type and loading, and other factors.

* 'g': grams; 'm/s': metres per second; 'J': joule.

Source: Ness and Williams (2015)

Image 4.1 Common rifle and machine gun cartridges



Note: (a) 5.56×45 mm; (b) 7.62×51 mm; (c) 7.62×39 mm; (d) 5.45×39 mm; (e) $7.62 \times 54R$ mm; and (f) 5.8×42 mm. The cartridges in this image are represented in their actual real-life dimensions.

Source: Anthony G. Williams/ARES

Consequently, handgun ammunition generally has a shorter effective range than rifle ammunition (typically of up to 100 m).⁸⁵ Due to the design imperative to fit ammunition inside a pistol's handgrip, these cartridges are limited in size. It is worth noting, however, that some ammunition used in rifles (notably .22 LR) also has a short case length (ARES, 2017).

Compared to rifle-calibre cartridges, which were largely standardized by most countries in the 20th century, different nations adopted a wide variety of handgun-calibre cartridges. Later in the 20th century, NATO and other Western coun-

⁸⁵ Some of the newer SCHV cartridges used by personal defence weapon (PDW)-type weapons can be effective up to 150 m or further in longer-barrel SMGs (ARES, 2017). When used in a SMG or carbine, the ammunition is sometimes loaded to higher pressures which, in conjunction with the longer barrel, may deliver increased performance (Popenker and Williams, 2012).

tries widely adopted the 9×19 mm and .45 ACP, while former Warsaw Pact nations largely standardized on the 9×18 mm cartridge. Some handguns and SMGs are chambered for other ammunition, such as the 5.7×28 mm FN round (ARES, 2016a). Table 4.2 and Image 4.2 show some common pistol-calibre cartridges.

Table 4.2 Selected common pistol cartridges worldwide

Cartridge designation	Country of origin	Bullet weight (g)*	Muzzle velocity (m/s)*	Muzzle energy (J)*
.45 ACP	United States	14.9	280	584
9×19 mm	Germany	8.0	440	774
9×18 mm	Soviet Union	6.1	310	348
.38 Special	United States	9.7	270	366
7.62×25 mm	Soviet Union	5.5	540	802
5.7×28 mm	Belgium	2.0	715	511
4.6×30 mm	Germany	2.0	720	520

Note: All figures are approximations and vary according to barrel length, cartridge type and loading, and other factors.

* 'g': grams; 'm/s': metres per second; 'J': joule.

Sources: Barnes and Woodard, 2016; Ness and Williams (2015)

Image 4.2 Common pistol cartridges



Note: (a) 9×19 mm; (b) 9×18 mm; (c) 7.62×25 mm; (d) .38 Special; (e) .45 ACP; (f) 5.7×28 mm; and (g) 4.6×30 mm. The cartridges in this image are represented in their actual real-life dimensions.

Source: Anthony G. Williams/ARES

Common cartridges for civilian applications vary significantly by country. In many countries, the cartridges in widespread civilian use reflect those in service with militaries and law enforcement agencies. In other countries, military cartridges are restricted or proscribed by law. In France, for example, any weapons chambered for common military calibres are subject to more stringent ownership requirements (France, n.d.). As a result, weapons originally chambered for cartridges in ‘military’ calibres are sometimes modified to fire ammunition not restricted under state law (McCollum, 2014a; Yasin, 2013).

Describing and identifying small-calibre ammunition

All small-calibre ammunition is of the same class (munitions (land)), group (projectiles), and subgroup (small-calibre ammunition) (ARES, forthcoming).⁸⁶ In order to determine the type, model, make, manufacturer, and other information, three steps should be taken:

1. Determine the cartridge designation.
2. Determine the country of origin, make and/or manufacturer, and/or year of production.
3. Determine the functional type.

While these steps are presented here in a logical order, it is often the case that information regarding, for example, a cartridge’s functional type may be established before, or in the absence of, a positive identification of the make or manufacturer.

Figure 4.2 shows one example of the thousands of cartridge configurations, which vary widely in terms of case composition, projectile and powder type, and case design. All of these characteristics are important for the identification process. Markings, including headstamps, also vary substantially, and the top and bottom codes do not necessarily correspond to ‘factory’ and ‘year’, as is the case in Figure 4.2. Many different types of cartridges are found in conflict zones. In general terms, the current norm in military small arms ammunition is centrefire ammunition (see below) with metal cases and jacketed projectiles.

⁸⁶ There are a very limited number of examples of small arms ammunition—mostly of novel designs such as miniature rockets—that do not fit into this group and subgroup (ARES, forthcoming). These types are almost never encountered in the field.

Figure 4.2 Basic composition of a 7.62 × 39 mm cartridge

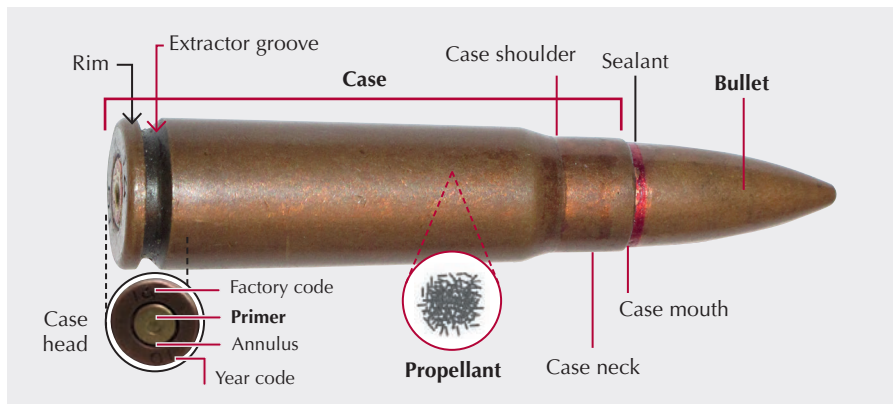

Source: N.R. Jenzen-Jones/ARES

Cartridge designation

The term ‘cartridge designation’ often refers to the cartridge’s calibre and case length (for example, 5.56 × 45 mm). In some cases, a descriptive term may also be included (for example, 5.56 NATO, or 5.56 × 45 mm NATO). The term ‘calibre’ is sometimes used as a stand-in for cartridge designation, but has its own definition (see below). The cartridge designation can generally be determined by taking physical measurements of the cartridge or cartridge case. This Handbook uses standard metric designations to describe cartridges, measured in millimetres. The calibre of the projectile is provided first (for example, 7.62), followed by the cartridge case length (for example, 39 mm). In this example, the cartridge designation would be 7.62 × 39 mm. For cartridges that are usually described using imperial measurements, the imperial measurement should be listed first, followed, if necessary, by the metric measurement in parentheses. An example would be: .303 British (7.7 × 56R mm). The calibre designation of a cartridge reflects the nominal projectile diameter (see next section). However, this is not necessarily a precise reflection of the projectile’s actual diameter. The case type may also be reflected in a cartridge’s designation (see ‘Cartridge case type and shape’ section).

Calibre

The first step in determining a cartridge designation is to identify the calibre of the cartridge. The calibre designation of a cartridge originates from the nominal

projectile diameter. The nominal projectile diameter is typically based on the bore of a weapon, as measured across the features of the weapon's rifling.⁸⁷ The calibre can be determined by measuring the diameter of the lands (X), the diameter of the grooves (Y), or the average diameter of both (X+Y divided by two) (see Figure 4.3).⁸⁸ In some cases, the nominal calibre—the calibre typically associated with the weapon—is an arbitrary figure, which is provided by the cartridge or weapon designer, or another party. For example, when the M40 recoilless rifle, a 105 mm calibre weapon, was adopted into US military service, it was described as 106 mm in order to avoid potential confusion with ammunition from the earlier 105 mm M27 (Jenzen-Jones, 2015c). Recovered projectiles can also be measured for calibre, and may bear rifling impressions that can help to determine the type of weapon from which they were fired (see Image 4.3).

Figure 4.3 Distance measured between the lands (X) or grooves (Y) of a rifled barrel

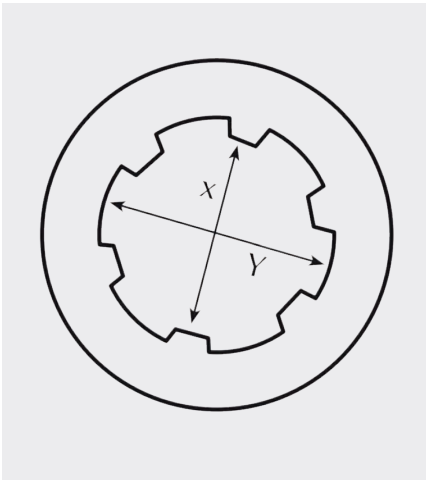

Source: ARES

Image 4.3 A fired projectile, showing characteristic impressions left by a weapon's rifling (lands)



Source: Diehl and Jenzen-Jones (2012)

⁸⁷ See Chapter 3 for a description of rifling.

⁸⁸ Some calibres (typically those using imperial measurements) are commonly measured between the grooves, instead of being based on the diameter of the lands of the barrel's rifling, although this is not always the case. The .303 British cartridge, for example, actually uses a .311 inch bullet when measured across the lands (7.70 mm vs. 7.90 mm) (Diehl and Jenzen-Jones, 2012).

Country of origin, make, manufacturer, and year of production

The country of origin, make and/or manufacturer, and year of production are typically identified by examining both the physical characteristics and markings. The cartridge's headstamp is generally the most important source of information on the manufacturer and production year. In Image 4.4, for example, '60' is the factory (and, in this case, manufacturer) code, while '75' indicates the year of production. It is worth noting that headstamp configurations are highly variable (see 'Headstamps and primers' section), and this represents a very simple-to-interpret example.

Image 4.4 Headstamp markings on a 7.62 × 39 mm cartridge case



Note: The markings show a factory code (60) and year of production (75).

Source: N.R. Jenzen-Jones/ARES

Once a country of origin and rough period of production have been ascertained, determining the cartridge's functional type is typically a straightforward task. It is most often indicated by projectile colouration, especially markings on the tip of a bullet, and/or by the physical features of a projectile or additional markings on the cartridge case.

Functional type

Different types of cartridges are produced to fulfil different roles. A wide range of functional types are produced, but which types are available varies by calibre. Common calibres favoured by both military and civilian users—such as 5.56 × 45 mm (and similar .223 Remington) or 7.62 × 51 mm (and similar .308 Winchester)—often have the widest variety of available types (see Image 4.5, for example). In modern military usage, ball projectiles, which feature an inert metal core, often made of lead or a combination of mild steel and lead, are the most common.⁸⁹ These cartridges are designed to engage personnel under most circumstances, and are typically cheaper to produce than other types.

Other common types of ammunition in military use include tracer, incendiary, armour-piercing (AP), and combination types. Many types of ammunition have combined effects, essentially combining two or more functional types (for example, armour-piercing incendiary (API); see Table 4.3). In civilian and law enforcement use, soft-point and hollow-point (HP) ammunition is common. These types of rounds are most often used for hunting and against human targets that are not wearing body armour, respectively.

A cartridge without a projectile is referred to as a 'blank', while inert cartridges are generally 'drill' or 'dummy' rounds.⁹⁰ Drill rounds are visually identifiable as inert cartridges by their lack of a primer, colour, and/or the shape of the case. Dummy rounds, on the other hand, are intended to look like live rounds, but have had their propellant removed and their primer fired (or otherwise rendered inert).

89 Ball ammunition is the most common type in military service due, in part, to a legal prohibition against the use of expanding bullets, which is outlined in the Declaration of Saint Petersburg of 1869, and the Hague Declaration of 1899 (IMC, 1868; IPC, 1899; Jenzen-Jones and Williams, 2016).

90 Grenade propelling cartridges, a type of blank, are used in conjunction with rifle grenades or grenade adapters to propel munitions from the rifle muzzle. They are sometimes known as 'grenade blanks'.

Table 4.3 outlines some common functional types of ammunition, their primary purpose, and typical users. It is worth noting that there are numerous exceptions to the examples provided here, and that there are other specialized types of ammunition that are not included in the table.

The important information to record and analyse when attempting to identify small-calibre cartridges by their physical characteristics and markings is addressed in the following sections.

Table 4.3 Purposes and users of ammunition by functional type

Functional type	Primary purpose	Typical users
Ball (full metal jacket; FMJ)	Anti-personnel	Military; law enforcement; civilians
Soft-point	Anti-personnel; hunting	Civilians
Hollow-point	Anti-personnel	Law enforcement; civilians
Tracer	Anti-personnel; aiming correction	Military
Incendiary	Anti-materiel; anti-armour (light vehicles)	Military
High-explosive (HE) and high-explosive incendiary (HEI)	Anti-armour (light vehicles); anti-materiel	Military
Armour-piercing (AP)	Anti-personnel; anti-armour (light vehicles)	Military
Subsonic	Anti-personnel; suppressed fire	Military; law enforcement
Blank	Training; movies/TV	Law enforcement; civilians
Grenade propelling	Firing rifle grenades	Military; law enforcement
Training	Training	Military; law enforcement
Inert (e.g. dummy and drill)	Training; collecting	Military; law enforcement; civilians

Image 4.5 Various types of 7.62 × 51 mm cartridges



Note: These include ball, blank, tracer, dim tracer, API, short-range training, and other types of cartridges.

Source: Drake Watkins/ARES

Physical characteristics

Cartridge case type and shape

In addition to the case length, cartridge cases are described by two additional primary physical characteristics: the type of case rim and the shape of the case walls. These characteristics are very useful when trying to determine cartridge designation. The case rim, where present, generally serves to aid in the extraction of fired cartridge cases from the weapon.⁹¹

Cartridges are produced with a number of distinct case rim designs. While most rims are simple enough to visually identify, it is somewhat more difficult to tell the difference between the various semi-rimmed and rimless ammunition in circulation. The most common cartridge case rims, examples of which are shown in Image 4.6, are as follows:

⁹¹ The presence, or absence, of a case rim and the design of a case's rim and walls also influence a weapon's headspace. Headspace, sometimes termed 'cartridge headspace' (CHS), is the distance from the face of the closed breech of a firearm to the surface in the chamber on which the cartridge case seats. Due to the high pressures involved, precise measurement and setting of CHS is crucial to the safe and reliable operation of a firearm. For a further discussion on CHS, see Ferguson (2015).

Image 4.6 Typical cartridge case rim configurations



Note: (a) Rimmed; (b) semi-rimmed; (c) rimless; (d) rebated rim; (e) rimless/grooveless; and (f) belted.

Source: Diehl and Jenzen-Jones (2012)

- **Rimmed** cartridge cases feature a case rim with a diameter that is greater than the diameter of the case body. The calibre designation of rimmed cartridges often includes the suffix 'R', for example, $7.62 \times 54R$. Some rimmed cartridges may use a rimfire priming system (see 'Headstamps and primers' section).
- **Semi-rimmed** cartridge cases have a case rim diameter which is slightly larger than the case body diameter. The calibre designation of these cartridges often ends in 'SR', for example, $7.65 \times 15SR$ (.32 ACP).
- **Rimless** cartridge cases feature a case rim diameter which is approximately the same as the case body diameter. Many modern military cartridges are rimless (including 9×19 , 5.56×45 , etc.).
- **Rebated rim** cartridge cases, sometimes known as 'reduced rim' cases, have a case rim diameter which is less than the diameter of the case body. The calibre designation of rebated cartridges sometimes includes the suffix 'RB', for example, $20 \times 110RB$. Rebated rim cartridges are most often encountered in relatively large bore rifle cartridges and cannon cartridges.
- **Belted** cartridge cases feature a raised portion on the case body (the 'belt'), typically located just above the extractor groove.⁹² The calibre designation of belted cartridges often includes the suffix 'B', for example $23 \times 152B$. Small-calibre examples are uncommon, but include several long-range rifle rounds. Several medium-calibre cartridges use belted cases (Goad and Halsey, 1982; Diehl and Jenzen-Jones, 2012).

⁹² Not strictly a rim characteristic, but a similar identifier.

Caseless ammunition also exists, but is very rare.⁹³

Cartridge case shape is often described as either straight-walled (straight) or tapered, either of which may also be bottle-necked (necked) (Barnes and Woodard, 2016; Diehl and Jenzen-Jones, 2012) (see Image 4.7).

Image 4.7 Common cartridge case configurations



Note: (a) Tapered (8 × 58R mm Sauer); (b) straight-walled (.40-72 WCF); (c) tapered bottle-necked (.280 Ross); and (d) straight-walled bottle-necked (.378 Weatherby).

Sources: Drake Watkins/ARES

93 For more information on caseless ammunition, see Jenzen-Jones (2016a). Similarly, rimless/grooveless cartridge cases are very unusual, and rarely encountered in the field. These cartridges have no rim at all; they exist with and without a bevel.

- **Straight-walled** cartridge cases are the simplest of case designs. Their case walls appear to be parallel or near-to-parallel when examined in profile. It should be noted that many cartridge cases typically considered to be ‘straight’ do, in fact, have a slight taper. Straight-walled cases are most commonly used in pistol-calibre cartridges.
- **Tapered** cartridge cases feature a noticeable taper in diameter along the length of the cartridge case, designed to aid in the extraction of the case after the cartridge is fired. The taper generally runs from the base of the cartridge to either the mouth or the shoulder.
- **Bottle-necked** (or simply ‘necked’) cartridge cases feature a relatively abrupt reduction in diameter toward the mouth (top) of the case. The vast majority of modern rifle and machine gun cartridges use necked cartridge case designs. Necked cartridge cases may be straight-walled or tapered in design.

The type and shape of a cartridge case are very useful distinguishing features for small-calibre cartridges, and are generally straightforward to assess. Physical features such as case rim type can often be assessed from images, assuming photographs taken in profile are available.

Case composition

Cartridge cases are made of a variety of materials, but the most common are brass, copper-clad steel, and coated (often ‘lacquered’) steel. The material type is often a good indicator of the factory or country of production. Some key materials are as follows (Diehl and Jenzen-Jones, 2012; Jenzen-Jones, 2016a):

- **Brass** is the most common cartridge case material. It is used primarily for its optimal elasticity, which allows for a consistently good case-bore seal when a weapon is fired. Most ‘cartridge brass’ is so-called ‘yellow brass’ (for example, Copper Alloy 260, C260), with a composition of roughly 70 per cent copper and 30 per cent zinc. Minor variations in brass composition are sometimes referred to as ‘brass alloy’ to distinguish them; however, this term is technically redundant.
- **Copper-clad steel**,⁹⁴ sometimes abbreviated CCS, is frequently and incorrectly referred to as ‘copper washed steel’. This case material is commonly used in cartridges from former Eastern Bloc countries.

94 The cladding is typically composed of 90–95 per cent copper + zinc.

- **Coated steel** is a common cartridge case composition, with various coatings having been applied over time. Two cartridges in Image 4.8—one in greenish translucent lacquer typical of Eastern Bloc military production (c), and one in light grey polymer (d) as seen in more recent Eastern Bloc commercial production and elsewhere—are typical examples.⁹⁵
- **Aluminium** is primarily used because it weighs less than other materials. It is most commonly encountered in certain practice ammunition, but is also available in various pistol calibres for regular use.⁹⁶ Aluminium cases may also be coated.

Image 4.8 Cartridges with cases made of various materials



Note: (a) Brass; (b) CCS; (c) and (d) two different lacquered steel examples; (e) aluminium; (f) polymer; (g) nickel-plated brass; (h) blackened.

Source: Diehl and Jenzen-Jones (2012)

- 95 Other lacquers in various shades of green, brown, grey, and other colours also exist. Various ‘washes’ and light coatings may also be used in the cartridge production process, regardless of cartridge case composition. These typically include acids, detergents, and anti-tarnish compounds.
- 96 Aluminium is easier to extrude than brass, but aluminium cartridge cases are not suitable for re-loading.

- **Polymer** (plastic) cartridge cases are most often used in dummy or training rounds, as well as shotgun cartridges. Polymer cartridge cases are not yet widely used because of ongoing performance issues. Nonetheless, a number of countries are exploring polymer cases, which weigh significantly less than conventional (metal) cases. Limited examples are now in service with some armed forces. The vast majority of polymer cased cartridges currently being produced use metal case heads to ensure reliable function (see Image 4.9).⁹⁷
- **Nickel-plated brass** cartridge cases are used mainly as an identification feature for special types of ammunition, such as high-pressure test rounds. Sometimes this finish is also encountered on blank and dummy/drill ammunition.

Image 4.9 Two cartridges of the same calibre (.264 USA)

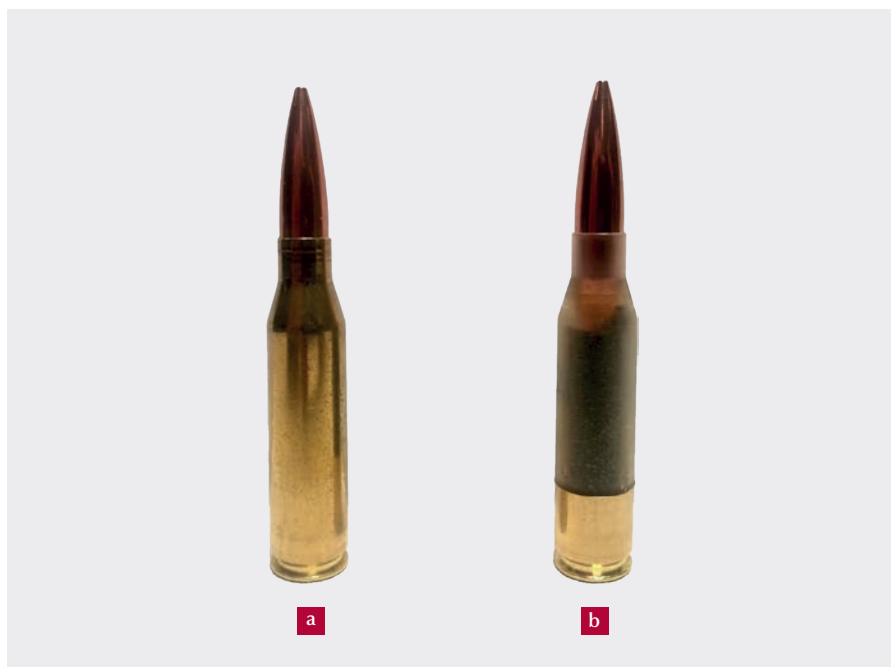

Note: (a) Conventional (all brass) construction; (b) polymer construction with a brass case head. Due to material differences, the internal dimensions of the cartridge case may be different.

Source: Rebekah Ehrich

⁹⁷ For more information on ammunition using polymer cartridge cases and other emergent ammunition technologies, see Jenzen-Jones (2016a).

Unusually-coloured cartridge cases, including blackened cases, generally serve as a marking feature for special purpose ammunition, such as high-pressure test rounds, dummy/drill cartridges, or other types (Diehl and Jenzen-Jones, 2012).

Some cartridge cases, most commonly those made of brass, may be suitable for 'reloading'—reuse after being fired. While reloading, or handloading, is most common in the civilian shooting world, some armed forces, law enforcement agencies, and armed groups also reload their ammunition. The latter, in particular, may resort to reloading ammunition when there is an insufficient quantity of industrially-produced cartridges or when their quality is poor. Cartridges may be reloaded to different specifications or purposes than the original round, and reloaded cartridges are often difficult for non-specialists to identify.

Projectile shape, weight, and jacket

The shape, weight, and jacket characteristics of a projectile can all help to identify ammunition. Projectile shape can vary significantly between calibres, and even among different types of ammunition in the same calibre. Several different 'loadings' of the same calibre and type may be produced, featuring different bullet dimensions and weights, differing amounts or types of propellant, and other changes. Image 4.10 shows four different projectiles for the 5.56 × 45 mm cartridge, of different functional types and projectile shapes. Three of these are the same weight (62 grains), despite clear differences in dimensions (i.e. shape).

The weight of a projectile is generally measured in grains (United States, United Kingdom) or grams (Europe). While it would be difficult for a layperson to determine a projectile's weight as part of an assembled cartridge, bullet weight is often marked on packaging—and even sometimes indicated directly or indirectly in a headstamp. Recovered projectiles may also be weighed. Bullet weight can sometimes, depending on the cartridge, help to determine the loading or functional type of a cartridge.

Most modern cartridges feature projectiles covered by a thin envelope of metal known as a jacket. Projectile jackets vary with the purpose of the cartridge (see Figure 4.4). Jackets are most commonly made from gilding metal (an alloy of copper and zinc), steel, or gilding metal-clad steel (GMCS). The latter is particularly common in Eastern Bloc ammunition (Diehl and Jenzen-Jones, 2012). Cartridges with so-called 'full metal jacket' (FMJ) projectiles are by far the most common, and ball ammunition, the most common type in military usage, features an FMJ.

Image 4.10 Different projectiles for the 5.56 × 45 mm cartridge



Note: (a) 55 grain jacketed soft point; (b) 62 grain M855 ball; (c) 62 grain M856 tracer; (d) early 62 grain M855A1 ball.⁹⁸
 Source: Drake Watkins/ARES

Figure 4.4 Examples of common projectile jacket configurations

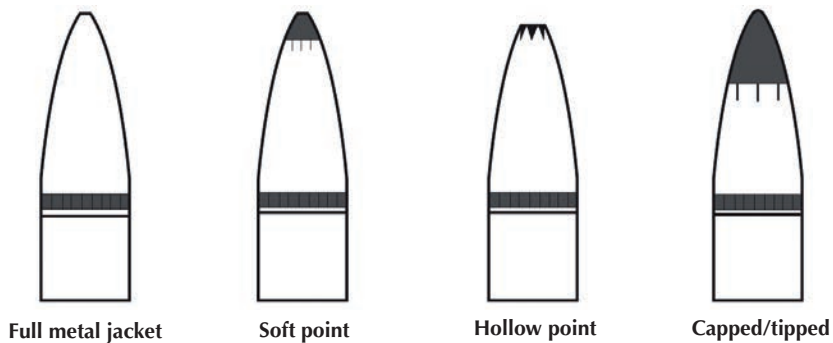

Source: ARES

⁹⁸ Some consider the M855A1 to be 'semi-armour-piercing', a term with no precise, established meaning.

For law enforcement and civilian applications, including hunting, expanding projectiles are often employed. These bullets generally fall into two broad categories: jacketed bullets in which the jacket does not cover the tip, leaving the lead core exposed (known as jacketed soft-point, or JSP); and bullets that have a deep cavity in the tip to encourage them to deform (known as jacketed-hollow point, or JHP).⁹⁹ These are distinct from precision target bullets that also have a reverse-drawn jacket that wraps around the base of the bullet, but leave only small hole in the tip (most often known as open-tipped match, or OTM). Some hollow point projectiles may be capped, or 'tipped', to increase aerodynamic stability (Jenzen-Jones and Williams, 2016).

Crimping, cannelures, and fluting

Primer crimping is intended to hold the primer in place during transport, handling, and firing of the weapon (especially in automatic weapons). Primers are often secured to cartridge cases using a variety of crimping and 'staking' methods, which appear as a 'stab', 'ring', 'box', or other types of indented markings on the case head (see Image 4.11c, d). Primer crimping may prove useful in distinguishing cartridges from different manufacturers, batches, lots, or periods of production.

Cannelures are used as crimping rings for the case neck, ensuring the projectile is securely seated at the correct depth in the cartridge case (see Image 4.11a). Cannelures may also help mate the core and jacket of a bullet together, and prevent the latter from 'shedding' once fired. When applied above the case mouth, cannelures and knurling of the projectile jacket are sometimes used for identification purposes (particularly on military cartridges) (see Image 4.11e). Cartridges may feature multiple cannelures.

Fluting is a term used to refer to a groove or series of grooves decorating the surface of a cartridge case. Fluting is most often seen on drill rounds, generally oriented longitudinally along the case (see Image 4.11b). This serves as a visual and tactile indicator to distinguish dummy from live cartridges.

99 There are non-jacketed versions of both types, as well.

Image 4.11 Examples of various crimping, fluting, and cannelures



Source: Diehl and Jenzen-Jones (2012)

Markings

Headstamps and primers

Cartridges typically feature alphanumeric characters and/or symbols applied to the base of cartridge cases, known as headstamps. Headstamps often provide valuable information about the country of origin, producer, year of production, calibre, or type of cartridge in question. Some headstamps also include the lot or batch number of the cartridge. The headstamp is most commonly applied to the cartridge case during the manufacturing process.

When documenting headstamps, it is customary to refer to the location of the markings as they would appear on a clock face. Image 4.12d is a typical Eastern Bloc headstamp, with the factory (manufacturer) code in the 12 o'clock (top) position, and the last two digits of the year of production in the 6 o'clock (bottom) position. It is important to note that headstamp configurations vary widely, as illustrated by the other examples in Images 4.12 and 4.13.

Two common priming methods are used with modern cartridges. Most small-calibre cartridges make use of a separate primer, a small metallic cup containing an impact-sensitive chemical compound that is struck by the firing pin of a weapon, releases energy quickly, and ignites the propellant in a cartridge. The primer is located centrally in the head of the cartridge case, and cartridges using this method of priming are known as centrefire cartridges.¹⁰⁰ Primers can be a useful identification feature based on their colour, and method of securing (including stakes and crimping; see Images 4.12 and 4.13). Some rimmed cartridges, referred to as rimfire cartridges, contain primer compound within the rim of the cartridge instead of a separate primer (see Image 4.12c). Rimfire cartridges are now uncommon in military and law enforcement services.

¹⁰⁰ The two most common small-calibre centrefire priming systems are known as the Berdan and Boxer types, after their inventors. Historically, cartridges using Berdan primers are more common in Europe (including widely-proliferated Eastern Bloc production from the Soviet Union, Russian Federation, and China), while those using Boxer primers are more common in the United States and Canada (Wallace, 2008). When primers have been ruptured or are absent from a fired cartridge case, images of the space left and the interior geometry of the case as viewed from the base of the cartridge can prove a useful identification feature.

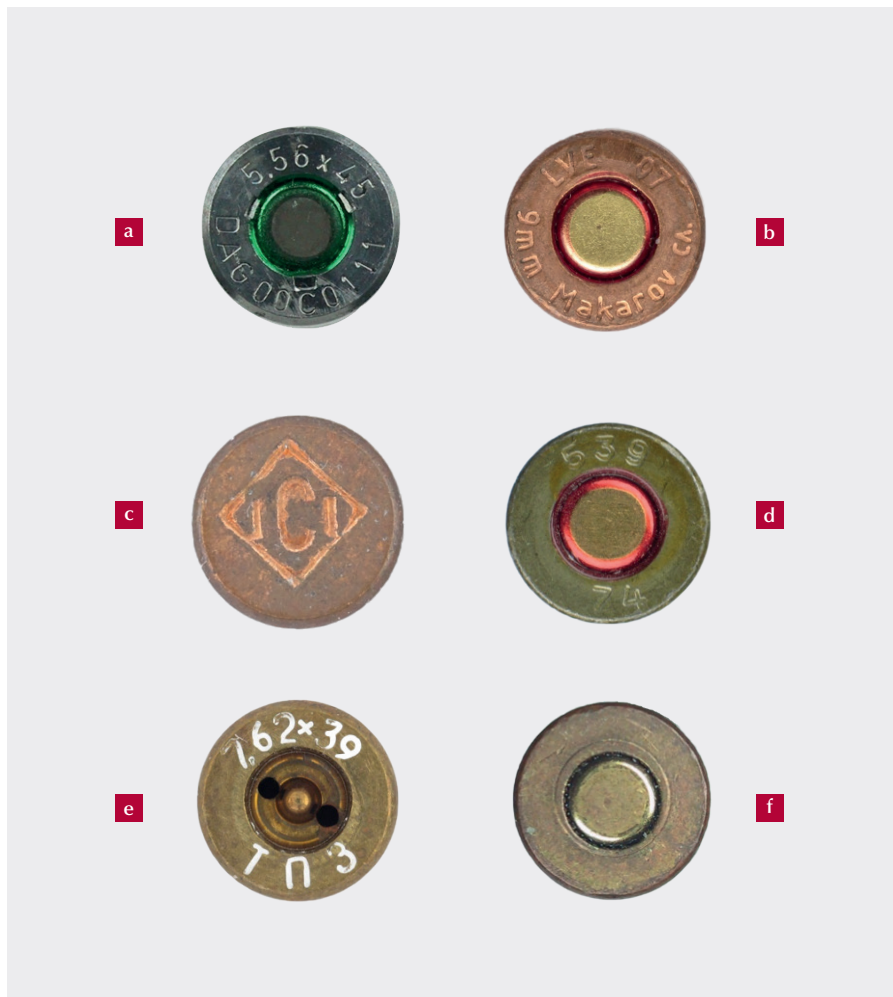
Image 4.12 Sample headstamps

- German 5.56 × 45 mm cartridge produced by Dynamit AG with 3-stab primer crimp. The lot number is required by law on German military ammunition.
- Russian 9 × 18 mm Makarov cartridge with unusual bi-script headstamp in Latin and Cyrillic. Manufactured by Novosibirsk Low Voltage Equipment Plant in 2007.
- British .22 LR rimfire cartridge produced by Imperial Chemical Industries.
- Russian/Soviet 5.45 × 39 mm cartridge made by what is now Tula Cartridge Works with standard Eastern Bloc headstamp configuration, giving the factory at the 12 o'clock position and the year of manufacture at the six o'clock position.
- Russian (commercial) headstamp of Tula Cartridge Works, with primer missing and Berdan priming system exposed, seen on a 7.62 × 39 mm cartridge.
- Unmarked 7.62 × 39 mm cartridge with ring-crimped primer.

Source: Diehl and Jenzen-Jones (2012)

Image 4.13 Further sample headstamps



- a. Danish 5.56 × 45 mm cartridge with three-stab primer crimp produced in 2009. The NATO Symbol of Interchangeability ('cross in circle') is at the 12 o'clock position.
- b. German .300 Winchester Magnum (7.62 × 67B mm) cartridge manufactured by Metallwerk Eisenhütte for export to the Slovakian Police.
- c. Saudi Arabian 7.62 × 51 mm cartridge with three-stab primer crimp, manufactured in Islamic Year 1425 (21 February 2004–9 February 2005). Note the palm tree and crossed swords, Saudi national symbols.
- d. British .303 cartridge made by Royal Laboratories in 1937 with a ring-crimped primer.
- e. Ukrainian .45 Rubber less-lethal cartridge made by Tekhkrim.
- f. Yugoslavian (now Macedonian) 7.62 × 39 mm cartridge with convex primer and distinct primer annulus sealant, produced by Suvenir AD.

Source: Diehl and Jenzen-Jones (2012)

Box 4.1 Unmarked, mismarked, and counterfeit headstamps

As with other arms and ammunition, cartridges can be copied or counterfeited. False markings may be intended to increase the commercial value of a cartridge, or simply to obscure its origins. An example of a counterfeit headstamp is shown in Image 4.14. The markings on this cartridge case indicate it was produced at the Royal Ordnance Factory Radway Green, in the United Kingdom, in 1960. However, an examination of the physical features of the cartridge (including the calibre and case composition), as well as a detailed assessment of the quality and nature of the markings, reveal that the cartridge in question was almost certainly produced in China (Diehl and Jenzen-Jones, 2012).

Image 4.14 A counterfeit 7.62 × 51 mm cartridge produced in China, marked so as to appear to have been produced in the United Kingdom



Source: Diehl and Jenzen-Jones (2012)

Cartridges are also found with unmarked or blank headstamps, or with errors and omissions in headstamps.¹⁰¹ For example, the cartridges shown in Image 4.15 are of Sudanese origin, produced by the Military Industry Corporation (Jenzen-Jones, 2014c). Recently-produced Sudanese cartridges typically feature a three-position headstamp (see Image 4.15b) that includes a calibre identifier (in this case, 39, indicating a 7.62 × 39 mm cartridge), a two- or three-digit code representing the year of manufacture (in this case 12, indicating production in 2012), and a single digit believed to represent the batch number or production line. The headstamp in Image 4.15a lacks this third marking. It is unclear whether this omission was deliberate, or a production error.

101 Errors and omissions may be introduced during the production process, or subsequently.

Image 4.15 Sudanese 7.62 × 39 mm cartridges

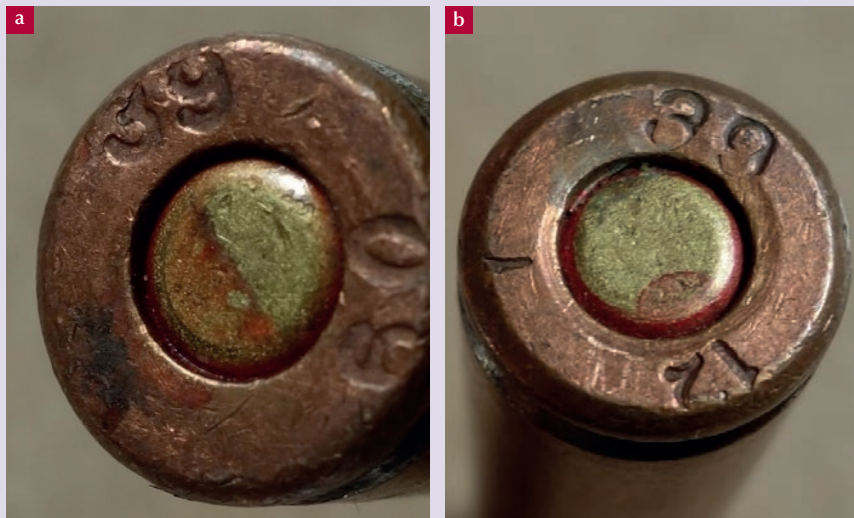

Note: (a) Cartridge produced in 2009 by Sudan's Military Industry Corporation, with just two markings, rather than the usual three. (b) A typically-configured cartridge of this period (produced in 2012) and calibre, which includes all three markings.

Source: C.J. Chivers/*The New York Times*

Finally, reloaded cartridge cases may bear headstamps that do not accurately reflect the type and nature of the cartridge in question.

It is also important to note that shotgun cartridges are particularly difficult to identify from headstamps alone.¹⁰² A range of third-party producers supply cases (and, less commonly, their components (hulls and brass heads)) to the manufacturers of complete cartridges. It is these third-party producers who often apply the markings to shotshell components, and sell the marked parts to a number of cartridge producers for assembly. Many shotgun cartridges supplied on military contracts also follow commercial marking practices, making them difficult to distinguish from cartridges manufactured and/or used for civilian purposes (Jenzen-Jones, 2014b).

Case markings (other)

Cartridge cases are sometimes marked in locations other than the case head (that is, feature markings other than headstamps). Markings on cartridge case walls often indicate special-purpose functional types, such as grenade blanks and training rounds, but are also present on shotshells.

¹⁰² Shotgun cartridges are sometimes called 'shotshells', a term which has been applied to various cartridges containing shot, not just those fired from shotguns.

Projectile colouration and markings

Projectiles are variously marked and coloured, generally to indicate their type or purpose. Markings on certain commercial cartridges are for branding or marketing purposes. A wide range of different projectiles with different marking schemes are available in common calibres. Image 4.16 shows several projectiles from 7.62×39 mm cartridges. It is worth noting the tip colours, as well as the variations in cannellures, sealants, jacket materials, and projectile shapes.

Various coloured paints and sealants may be applied, sometimes in more than one colour. It is not uncommon, for example, for a projectile tip to have two colours (often indicating functional type). The tip marking is often in addition to a sealant, which may be a different colour. Ammunition commonly documented in conflict zones will often follow either Warsaw Pact or NATO markings schemes, which are generally as shown in Tables 4.4 and 4.5 and Figures 4.5 and 4.6.

Image 4.16 Various 7.62×39 mm cartridge projectiles from a range of countries and manufacturers



Note: (a) Tracer (Soviet Union); (b) tracer (Soviet Union); (c) tracer (Yugoslavia); (d) tracer (Finland); (e) armour-piercing (Czechoslovakia); (f) armour-piercing (Yugoslavia); (g) ball with mild steel core (Czechoslovakia); (h) ball with mild steel core (Albania); (i) ball with lead core (Finland); and (j) high-pressure test projectile (German Democratic Republic).

Source: Diehl and Jenzen-Jones (2012)

Table 4.4 Selected Warsaw Pact projectile colour codes

Projectile colour	Cartridge type
No colour	Ball
White (tip)	Ballistic reference ball
Silver (tip)	Light ball with steel core
Yellow (tip)	Heavy ball
Green (tip)	Tracer
Green (entire projectile) or black (tip) with green band	Subsonic
Black (tip)	Armour-piercing (AP)
Black (tip) with red band or red (entire projectile) with black tip	Armour-piercing incendiary (API)
Violet (tip) with red band	Armour-piercing incendiary tracer (API-T)
Red (tip)	Incendiary
Red (entire projectile)	High-explosive incendiary (HEI)

Note: This is a non-exhaustive list; several exceptions and contradictions exist.

Sources: Koll (2009); USSR (1946)

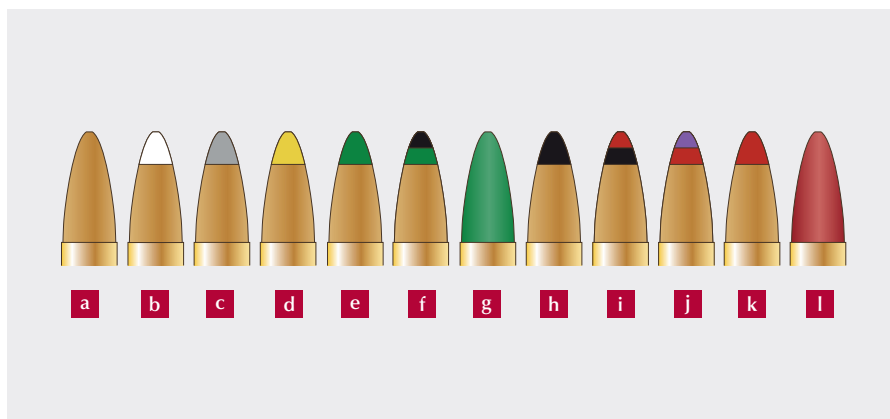
Figure 4.5 Selected Warsaw Pact projectile colour codes

Note: (a) Ball (FMJ); (b) ballistic reference; (c) light ball; (d) heavy ball; (e) tracer; (f) subsonic; (g) subsonic; (h) AP; (i) API; (j) API-T; (k) incendiary; (l) HEI.

Source: ARES

Table 4.5 Selected NATO and associated military projectile colour codes

Projectile colour	Cartridge type
No colour	Ball
Green (tip)	Ball
Red (tip) or orange (tip)	Tracer
Black (tip)	Armour-piercing (AP)
Blue (entire projectile) or blue (tip)	Short-range training
Blue (entire projectile) with red tip or red (tip) with blue band	Short-range tracer training
Violet (tip)	Dim tracer
Red (tip) with yellow band	Observation
Silver (tip) or green (tip) with silver band	Armour-piercing incendiary (API)
Red (tip) with silver band	Armour-piercing incendiary tracer (API-T)
Violet (tip) with silver band	Armour-piercing incendiary dim tracer (API-DT)

Note: This is a non-exhaustive list; several exceptions and contradictions exist.

Sources: US DoD (2009); Williams (n.d.)

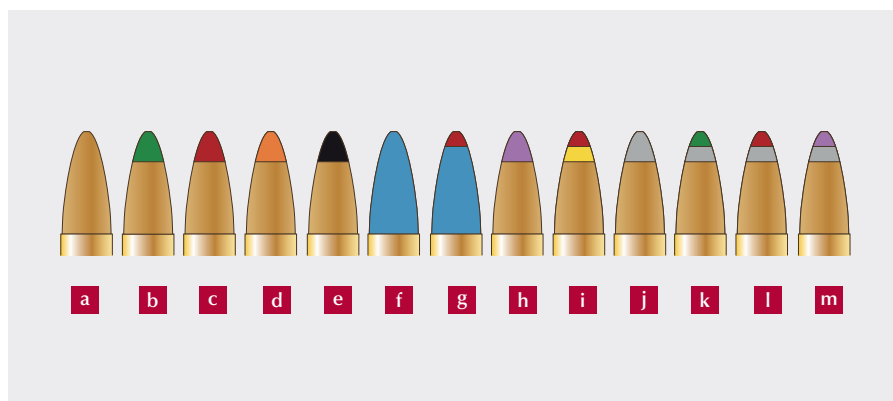
Figure 4.6 Selected NATO and associated military projectile colour codes

Note: (a) Ball (FMJ); (b) ball (FMJ); (c) tracer; (d) tracer; (e) AP; (f) short-range training; (g) short-range tracer training; (h) dim tracer; (i) observation; (j) API; (k) API; (l) API-T; (m) API-DT.

Source: ARES

Figure 4.7 Examples of the different colours, types, and application locations of sealants



Sources: Diehl and Jenzen-Jones (2012); Damien Spleeters; N.R. Jenzen-Jones/ARES

Sealants

Sealants, which are commonly used to protect the round from moisture, are occasionally useful for identifying the type or production batch of a particular cartridge. Some cartridges feature primers or projectiles that are entirely coated in a sealant. The cartridge in Figure 4.7e, a Romanian made 14.5 × 114 mm MDZ high-explosive incendiary cartridge, features a sealant-coated projectile and case mouth sealant. Figure 4.7f, a Vietnamese 7.62 × 39 mm cartridge, shows case mouth sealant. In some instances, sealants are made from a rubberized polymer or have an opaque finish (see Figure 4.7d).

Packaging

Packaging for small-calibre ammunition is another valuable source of information. Such packaging often consists of several layers. Individual rounds for rifles and handguns are typically packaged in paper and/or card wrappers and cardboard

Box 4.2 Myths and misconceptions: ‘poisoned bullets’

Reports of ‘poisoned bullets’ are sometimes encountered in conflict areas, including Afghanistan, Iraq, Libya, Syria, and Yemen. In Libya in 2011, rebel fighters reported to ARES researchers that they had recovered ‘poison-tipped ammunition’ from regime forces. These cartridges, photos of which were shared with ARES, feature a green tip colouration. One fighter said: ‘The green is to indicate the bullet is poisoned. When shot at someone venom is injected and he dies instantly.’¹⁰³

In fact, the 7.62 × 39 mm cartridges in question were tracer cartridges. While some limited examples of small-calibre projectiles containing biological or chemical agents have been produced by governments, they are nearly unheard of in conflict zones. Some non-state actors have experimented with cartridges containing noxious substances, including the Islamic State group in Syria.¹⁰⁴ These rounds are extremely rare, however, even in regions where governments or armed groups have reportedly developed—or attempted to develop—ammunition containing biological or chemical agents.

boxes (see Image 4.20), usually in multiples of five or ten. A ‘card wrapper’ is a single piece of card wrapped around some or all of the cartridges in a container. Some ammunition, particularly pistol-calibre ammunition, may be packaged in plastic trays, which are sleeved inside a cardboard box (see Image 4.19). Even seemingly mundane pieces of packaging such as card wrappers may contain markings or physical features which can be interpreted by specialists. The next layer of packaging for military-issued ammunition typically consists of a metal storage container, or ‘tin’. Belted ammunition is typically placed directly into the containers (that is, without additional inner packaging). The metal containers are then packed into shipping crates (see Image 4.17). The markings on all layers of packaging contain important information about the age, country of origin, make, model, and/or purpose of their contents. Examples of this packaging, and the information conveyed by their markings, are provided below. The paperwork found inside of, or accompanying, boxes and crates often contains additional information.

All markings on packaging for small arms ammunition should be recorded, as should the contents of documents found inside of ammunition crates and boxes. Image 4.17 shows an example of the markings on the outer packaging of some small-calibre cartridges. The box marking indicates the calibre (7.62); cartridge

103 ARES interviews with confidential sources.

104 ARES interviews with confidential sources. A Norwegian right-wing extremist also reportedly planned to incorporate chemical agents into small-calibre ammunition (Diethelm and McKee, 2011).

type (Б-32; B-32, an API designation; this also makes it possible to determine the complete cartridge designation, in this case 7.62 × 54R); case type (ГЖ; GZh, 'bi-metallic' also known as copper-clad steel); number of cartridges (880 IIIТ; 880 sht, or pieces); cartridge lot number (04); year of manufacture (1977); and factory code (17; factory code for Barnaul Machine Tool Plant JSC, in what was then the Soviet Union).¹⁰⁵ The crate also contains information relating to the propellant type, lot, year of manufacture, and source. Image 4.18 shows a representative 7.62 × 54R mm B-32 cartridge such as would be contained within this packaging. The copper-clad steel cartridge case and tip colour code (black over red, indicating an API projectile) matches the information on the box in Image 4.17.

Image 4.17 Common markings on Eastern Bloc outer packaging (wooden crate)



Note: This crate contains Soviet 7.62 × 54R mm API cartridges.

Source: Small Arms Survey

¹⁰⁵ Now Barnaul Cartridge Plant CJSC.

Image 4.18 A representative Soviet 7.62 × 54R mm B-32 cartridge



Source: 7.62x54r.net

Figure 4.8 Typical marking format on Eastern Bloc inner packaging (metal tin) containing Soviet 7.62 × 54R mm light ball cartridges

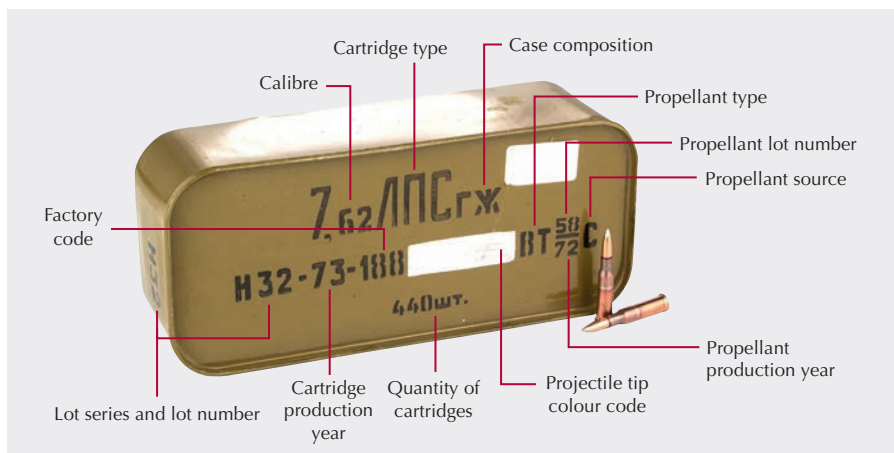

Source: Bulkammo.com

Image 4.19 American Armscor USA .22 TCM cartridges in cardboard packaging with an inner plastic tray, common to modern commercial ammunition



Source: N.R. Jenzen-Jones/ARES

Image 4.20 Examples of cardboard inner packaging associated with cartridge-based ammunition (especially small arms ammunition)



Note: These are examples of Eastern Bloc packaging. In the centre column (and one example in the left-hand row), the coloured stripes indicate the tip colour code—and hence cartridge type—of the ammunition. Source: Diehl and Jenzen-Jones (2012)

— Author: N.R. Jenzen-Jones

CHAPTER 5

Weapons Identification: Light Weapons and their Ammunition

Introduction

Light weapons as a class of arms offer far more firepower than small arms but retain a degree of portability, making them a potent threat in any conflict zone. These weapons are often mounted to vehicles for rapid and flexible deployment. Different types of light weapons are designed for engaging different types of targets, from personnel to aircraft. As such, light weapons range from extraordinarily simple to highly complex weapon systems, and make use of a variety of operating principles and ammunition types.

Light weapons are often described as either ‘direct-fire’ or ‘indirect-fire’ weapons.¹⁰⁶ Direct-fire weapons are aimed directly at the target and are generally employed when a target is visible. Direct-fire weapons include small arms, heavy machine guns, light cannon, recoilless weapons, some rocket and missile launchers, and some grenade launchers. Direct-fire weapons are often more accurate than indirect-fire weapons, but generally have shorter ranges and projectiles with smaller payloads (Cross et al., 2016, p. 43).

Indirect-fire weapons are typically employed when the target cannot be observed, is protected by geographic or structural features, or is located a significant distance away. These weapons include mortars, some grenade launchers, some rocket and missile launchers, and larger artillery (Dullum et al., 2017, p. 12).

This chapter begins with a brief overview of key types of light weapons, their physical characteristics, and their markings. A similar analysis of ammunition for light weapons is then provided. The chapter concludes with a brief section on the packaging and documentation often encountered with light weapons and their ammunition.

History and technical development

Heavy machine guns

Heavy machine guns (HMGs) are crew-served automatic firearms, chambered for a cartridge of more than 8 mm but less than 20 mm in calibre (ARES, 2017). One of the earliest and most influential examples of these weapons is the US

¹⁰⁶ A small number of light weapons are capable of both direct and indirect fire.

Browning M2 (1936), which was designed for use against armoured vehicles and was chambered for the 12.7 × 99 mm cartridge (see Image 5.1). The M2 was soon rivalled by the Russian DShK (1938), which is chambered for a comparably large cartridge (12.7 × 108 mm) (see Image 5.2). Both guns are belt-fed and typically mounted on vehicles or large, heavy tripods. They were generally used against targets located between 300 and more than 1,000 metres away. Both weapons have been updated since their inception and remain in widespread use alongside more modern models (ARES, 2016a; 2017).

A typical infantry HMG crew consists of a minimum of three operators: one to carry the gun, one the mount, and one or more to carry and load ammunition. HMGs are often used to deliver sustained fire in situations where small arms would be prone to overheating. Some early HMGs featured water cooling systems, but most now have very heavy and/or interchangeable barrels to deal with the

Image 5.1 A Russian DShKM HMG



Source: Small Arms Survey

Image 5.2 An American Browning M2 HB HMG



Source: US Department of Defense

high temperatures generated by automatic fire. So-called 'quick-change' barrels are increasingly common, allowing operators to replace overheated or worn barrels rapidly (ARES, 2017).

Light cannon

The term 'light cannon' encompasses several types of rifled firearms chambered for medium-calibre cartridges (20 mm – <57 mm) that meet the criteria of light weapons (ARES, 2017). Most of the weapons in this category are considered to be 'anti-materiel rifles' (AMRs) (see Image 5.3; Chapter 3), but the category also includes a smaller number of semi-automatic and automatic weapons designed to be employed from a mount or vehicle. These latter weapon systems are commonly referred to as 'autocannon' and are often, although not exclusively, employed in an anti-aircraft role (see Image 5.4). Most of these weapons are too heavy to be considered 'light weapons'; however, a handful meet the light weapons' weight and crew criteria. The cut-off between medium- and large-calibre ammunition is

Image 5.3 A South African Denel NTW20 20 × 82 mm² light cannon, considered by many to be an anti-materiel rifle



Source: US Department of Defense

Image 5.4 A Solothurn S18-1100 20 × 138B mm autocannon, in an anti-aircraft mount



Source: Wikimedia Commons/Hmaag

generally understood to be 57 mm; this therefore provides the theoretical upper limit for this class. In practice, the clear majority of weapons in this category are chambered for 20 mm cartridges (ARES, 2016a; 2017). Exceptions include craft-produced AMRs chambered for the powerful 23 × 152B mm cartridge, which have been employed by a range of non-state actors in Iraq, Syria, Ukraine, Yemen, and elsewhere (Hays and Jenzen-Jones, 2018). Several weapon systems commonly and erroneously considered to be light cannon do not meet the definition of light weapons because of their total system weight, and so are excluded from this category. The excluded weapons are generally considered ‘medium cannon’. An example is the Soviet ZU-23-2 (ARES, 2017).

Shoulder-fired grenade launchers

Hand-held grenade launchers are weapons that fire specially-designed subsonic cartridges or semi-caseless ammunition of 20 mm to 40+ mm calibre, typically to a maximum range of 400–1,000 m (see, for example, Images 5.5 and 5.6). Grenade launchers generally fire projectiles containing high-explosive (HE) warheads, but most launchers also fire other projectiles, such as inert training, less-lethal, and illumination ammunition (ARES, 2017).¹⁰⁷ In military use, grenade launchers are generally issued at the infantry section or squad level. Recent developments

¹⁰⁷ Illumination rounds are designed to provide supplemental visible spectrum and/or infrared (IR) light to aid in operations. This is usually achieved by ignition of a pyrotechnic candle or flare (US Army, 1991). The increased use of night vision devices in combat has resulted in the development of IR spectrum candles that do not emit any appreciable visible light. See, for example, Bacon (2011).

Image 5.5 An American M79 break-action 40 × 46SR mm grenade launcher



Source: N.R. Jenzen-Jones/ARES

Image 5.6 A Bulgarian Arsenal MSGL revolver-type 40 × 46SR mm grenade launcher



Source: Wikimedia Commons/Marinajord

include computer-controlled sighting and fuzing systems that allow for the detonation of ammunition over targets hiding behind low walls, earth berms, hills, and other uneven terrain ('airburst') (Jenzen-Jones, 2015a). Several modern grenade launchers are designed for standalone use or as under-barrel launchers (ARES, 2017).¹⁰⁸

Broadly speaking, launchers in 40 mm calibres are multipurpose (that is, able to fire different ammunition types), and almost invariably have rifled barrels (ARES, 2017). While outwardly similar in appearance, so-called 'riot guns', commonly chambered for 37/38 mm projectiles, are specifically designed for non-lethal and less-lethal applications including the launching of flares, and predominantly have smooth-bore barrels (ARES, 2017).

¹⁰⁸ Examples include the German Heckler & Koch GLM (M320 in US military service) and Belgian FN Herstal FN40GL.

Auxiliary grenade launchers

Auxiliary grenade launchers, most commonly under-barrel grenade launchers, were first deployed experimentally by the United States in the Vietnam War. The first widely issued model was the US-designed Colt M203 (1969), a breech-loading weapon chambered for the 40 × 46SR mm cartridge. Russia followed a different development path and introduced the muzzle-loading GP-25 in 1978, firing a semi-caseless 40 mm projectile (see Image 5.7). Both models were designed to be mounted on an existing weapon (the 'host weapon'), typically an infantry rifle (ARES, 2017). Auxiliary grenade launchers usually consist of a barrel, a trigger mechanism, some sort of mounting system, and a special sight (typically a 'ladder sight') that is fitted to the host weapon (see Images 5.8 and 5.9). Most designs are manually operated, with some form of sliding or pivoting barrel to provide access for loading. Grips and butt-stocks are typically not included, but recent designs allow for the addition of a gripstock, effectively converting the weapon into a hand-held launcher (ARES, 2017). Some modern launchers also feature electronic aiming aids or sensor fuzing (see Box 5.1).

Image 5.7 A Serbian Zastava Arms BGP40 semi-caseless 40 mm under-barrel grenade launcher, a close copy of the Soviet GP-25 design



Source: N.R. Jenzen-Jones/ARES

Image 5.8 A US M203A2 manually-operated 40 × 46SR mm under-barrel grenade launcher mounted to an M4A1 self-loading rifle



Source: US Air Force

Image 5.9 A Belgian FN Herstal FN40GL manually-operated 40 × 46SR mm under-barrel grenade launcher mounted to a FN Herstal SCAR-L self-loading rifle



Source: N.R. Jenzen-Jones/ARES

Crew-served grenade launchers

Crew-served grenade launchers are self-loading guns that fire medium-calibre explosive projectiles at relatively low velocities and at a relatively slow rate of automatic fire (ARES, 2017; Jenzen-Jones, 2015a, pp. 1–2). Sometimes called automatic grenade launchers (AGL) or grenade machine guns (GMG), these weapons are typically belt-fed and are operated by a small crew (see, for example, Image 5.10). The first widely issued crew-served grenade launcher was the US-designed Hughes MK 19 (1968), which was quickly followed by the Russian AGS-17 in 1971. Crew-served grenade launchers are generally intended for defending static positions and supporting infantry, but are often adapted for use on vehicles, including aircraft. Recent development trends include longer-range ammunition, and the increased use of sophisticated fire control systems (FCS) to enhance accuracy and achieve specific effects such as airburst (Jenzen-Jones, 2015a, p. 2; ARES, 2017; see Box 5.1 and Image 5.11).

Image 5.10 A Russian AGS-30 AGL with a simple optical sight



Source: Wikimedia Commons/Vitaly V. Kuzmin

Image 5.11 A US General Dynamics Ordnance and Tactical Systems MK 47 Mod 0 STRIKER AGL with a Raytheon Lightweight Video Sight fire control system



Source: Australian Department of Defense

Box 5.1 FCSs and airburst munitions for AGLs

There has been a limited trend towards lightweight AGLs fitted with advanced FCSs (see Image 5.11), often paired with an airburst munitions (ABMs) capability (see Image 5.12). Use of these control systems increases the probability of hitting the target with the first round, allowing operators to surprise adversaries, rapidly engage multiple targets, and reduce ammunition consumption. The increased accuracy provided by these systems also has the potential to reduce collateral damage. Using FCSs with ABMs allows operators to reliably engage targets hidden behind hills or other features of the terrain for cover (targets 'in defilade') (Jenzen-Jones, 2015a, p. 2).

ABMs use information provided by the FCS to program the projectile to detonate at a precise point in space above or next to the target. The rounds are typically programmed either through contact with the barrel of the weapon, or through radio frequency (RF) or infrared (IR) signals (Jenzen-Jones, 2015a, pp. 2–3). Some FCS are integral to the weapon system, while others can be added to existing guns.

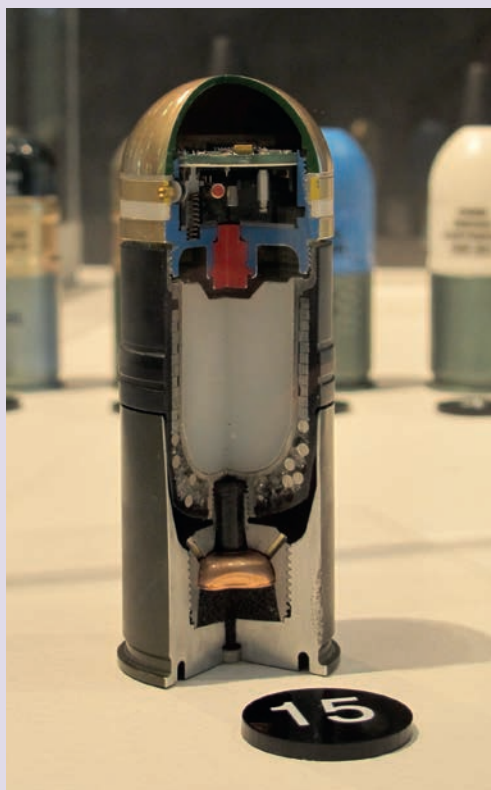

Image 5.12 Nammo MK 285 programmable pre-fragmented high-explosive (PPHE) 40 × 53SR mm ABM

Source: N.R. Jenzen-Jones/ARES

Light and medium mortars

Light and medium mortars are portable, indirect-fire infantry support weapons. Modern mortar designs date back to the early 20th century and consist of a simple smooth-bore barrel (sometimes called a 'tube') with a fixed firing pin at the base that fires the round when it is dropped into the tube. The tube is generally attached to a baseplate and supported by a bipod (see Image 5.13). This light-weight, tactically flexible design has proved useful, and weapons of the same basic type have been in use ever since (Bull, 2004, pp. 181–82; ARES, 2017).¹⁰⁹

¹⁰⁹ There are a few rare exceptions, such as breech-loading mortars which can be employed in the direct-fire role. Alternative propulsion systems have also been developed, notably the German Rheinmetall 'FLY-K' system and its copies, which effectively suppress both sound and infrared signatures (Jones and Ness, 2013).

Image 5.13 A British Stokes 3-inch 'light trench mortar'



Source: Imperial War Museums

Image 5.14 Serbian M69 82 mm mortar (foreground) and M57 60 mm mortar (background)



Source: Wikimedia Commons

The main advances in mortar technology since 1918 have been in projectile and propellant design. Recently-produced mortar rounds have an aerodynamically shaped warhead with an additional finned propulsion tail section, which together increase range, accuracy, and precision.

Like machine guns, mortars are commonly classified by their intended role, which correlates with calibre and portability. Generally, the larger the projectile, the longer its range. 'Light mortars' (50–60 mm) have typical ranges of one to three kilometres; a 60 mm mortar is the upper practical limit in size for a crew of three, largely due to the weight of the ammunition. NATO and other 'Western' military forces generally use 81 mm calibre weapons for 'medium mortars', while former Warsaw Pact countries primarily employ 82 mm equivalents (ARES, 2017; Jones and Ness, 2013; see Image 5.14). Generally speaking, these systems have effective ranges of three to six kilometres and require a crew of four or five to carry and operate. 'Heavy mortars' are similar in function and capabilities to larger towed mortars and other artillery pieces; several common heavy mortars have ranges in excess of seven kilometres, with very large systems reaching as far as ten kilometres (Jones and Ness, 2013).

When firing a typical mortar, the range of the projectile and the point of impact can be adjusted both by angling the tube and, generally, by using different sizes or quantities of auxiliary propellant charges, which increase the range of the mortar round (Hogg, 2001). Firing in a very high, arcing trajectory, mortars require specific sighting and laying systems. Conventional mortars do not have recoil mechanisms, with the main recoil force being transmitted directly to the ground via the baseplate. Most mortars are only capable of firing at high-angle trajectories (above 45 degrees), precluding their use as direct-fire weapons. There are exceptions, including rifled mortars, direct-fire mortars, and self-loading mortars (Dullum et al., 2017, pp. 27, 30), but these systems are limited in number.

It is now possible to employ Global Positioning System (GPS) and laser-guided projectiles from existing mortar systems. These guided mortars are now produced and employed by several states, and offer significant advantages over traditional systems, most notably greatly enhanced precision. Often, no modifications are necessary to the mortar itself, since the guidance system is located within the projectile or is part of a bolt-on upgrade kit for existing rounds (see Image 5.44) (Jenzen-Jones, 2015b, pp. 1–2).

Recoilless weapons

Recoilless weapons are generally sorted into two subcategories: crew-served recoilless weapons and shoulder-fired recoilless weapons (alternatively called hand-held recoilless weapons; see Image 5.15).¹¹⁰ Common crew-served recoilless weapons include the American 106 mm M40, and the Soviet-designed 82 mm B-10 (1954) and SPG-9 (1962) (Tucker, 2015; see Image 5.16). The second subcategory of recoilless weapons includes the widely proliferated RPG-7-pattern launchers (1961) (see Box 5.2) and the Swedish 84 mm Carl-Gustaf (1946). These weapons are usually carried and fired from the shoulder of a single operator. Even though these weapons were developed decades ago, many are still in use, and despite numerous upgrade programmes, key operating principles have changed very

¹¹⁰ The first recoilless weapon adopted for military service used an operating principle which employed a counter-mass of lead balls to equalize the otherwise high recoil generated on firing a large and heavy projectile. Later designers realized that it was possible to utilize less hazardous counter-mass materials such as powders or liquids, or even to rely upon the propellant gases alone (Jenzen-Jones, 2015c, pp. 1, 3–4). Some recoilless weapons feature an auxiliary co-axial gun (often termed a ‘spotting rifle’) to facilitate aiming (ARES, 2017).

little since they were first introduced. Manufacturers, however, have introduced several new types of ammunition, including rounds with tandem charges to defeat reactive and bar armour, multipurpose ('bunker-buster') rounds, along with anti-personnel, illumination, smoke, and training/practice (TP) rounds (ARES, 2017; Jenzen-Jones, 2015c).¹¹¹

Image 5.15 A Swedish Saab AT4 shoulder-fired recoilless weapon



Source: Saab

Image 5.16 A Russian SPG-9 crew-served recoilless gun



Source: Small Arms Survey

¹¹¹ Smoke is primarily used as an obscurant to mask the location or movement of military units, but also for signalling and diversion purposes. Different smoke compounds and release mechanisms are designed to provide smokescreens of specific size, duration, and effect (US Army, 1991, p. 12). Some smoke compositions (for example, white phosphorous) can have an incendiary effect.

Rocket launchers

The first anti-tank rocket launcher to be widely fielded was the US M1 Bazooka (1942). The Bazooka and its successors are sometimes referred to as 'man-portable anti-tank systems' (MANPATS or MPATS). However, they are also frequently used to engage other types of vehicles, infantry, structures, and occasionally even aircraft.¹¹² The rocket launch tube may be reloadable, or disposable, in which case only one round is fired and the tube is then discarded (see Image 5.17). Rocket launchers should not be confused with recoilless weapons (see Box 5.2) despite their overlapping role and some similar operational characteristics (ARES, 2017).

As with recoilless weapons, rocket launchers are divided into two broad categories: crew-served and shoulder-fired (or 'hand-held') (ARES, 2017). Crew-served rocket launchers are almost invariably reloadable. Some shoulder-fired launchers are reloadable while others are disposable.

Image 5.17 American Talley Defense Systems M72 light anti-tank weapon (LAW) series shoulder-fired disposable single-shot 66 mm rocket launchers



Note: (a) M72A3 in extended (ready-to-fire) position; (b) M72 in stowed position.

Source: Bear Arms Firearms Reference Collection via ARES

¹¹² Some variants of rocket launchers designed for use against structures are known as 'anti-structure munitions' or 'ASM' (ARES, 2017).

Box 5.2 Myths and misconceptions: ‘rocket launchers’ versus ‘recoilless weapons’

The difference between rocket launchers and recoilless weapons is a consistent source of confusion. The confusion stems in part from the fact that rocket launchers such as the M72 LAW are sometimes described as recoilless, in the sense that the operator perceives very little recoil. The key difference, however, is that rocket launchers do not propel rockets, which incorporate their own source of propulsion and would still fire successfully if ignited outside their launch tube (Newhouse, 2011). In contrast, recoilless weapons have a functional barrel that contributes directly to the acceleration of the fired projectile, which is propelled out of the barrel by the expanding gases generated by burning propellant.

Several common light weapons employ a combination of recoilless and rocket propulsion principles. Typically, these systems use an expelling charge to launch a projectile a short distance from the weapon, at which point a rocket motor ignites and propels the projectile towards the target. A well-known example of such a system is the RPG-7 (see Image 5.18). A typical RPG-7 round, such as the PG-7V, uses an expelling charge—often erroneously referred to as a ‘booster section’—to launch the projectile several metres from the barrel before the rocket motor engages and provides most of the required acceleration (US Army TRADOC, 1976). This ‘two-stage’ launch protects the operator from the rocket’s back blast. The most common ammunition fired from RPG-7-pattern launchers employ a combination of recoilless and rocket propulsion principles, while some projectile types, including the widely proliferated OG-7V anti-personnel round, operate purely on the recoilless principle. Other hybrid systems include the German Panzerfaust 3 and the Swedish AT4 (Jenzen-Jones, 2015c, p. 2; see Image 5.15).

Image 5.18 A Russian RPG-7V shoulder-fired recoilless weapon



Source: Small Arms Survey

Anti-tank guided missile systems

As the name implies, man-portable anti-tank guided missile (ATGM) systems are distinguished from unguided anti-tank systems such as the RPG-7 or Carl-Gustaf by the incorporation of targeting and guidance systems. ATGMs, which are also referred to as anti-tank guided weapons (ATGWs), were originally designed to

disable armoured vehicles, but are frequently employed against other targets, such as personnel, light vehicles, and hardened structures (Jenzen-Jones, 2017a, p. 1).¹¹³

First-generation ATGM systems, including the widely proliferated Russian 9K11 Malyutka, operate on the ‘manual command to line-of-sight’ (MCLOS) principle, requiring an operator to manually guide the missile onto the target. The operator uses a joystick-like control that sends signals to the missile through thin wires trailing behind it (Fulmer, Jenzen-Jones, and Lyamin, 2016; Jenzen-Jones, 2017a, p. 1). This guidance system requires a high degree of skill to operate (Jenzen-Jones, 2017a). Many first-generation missiles were fired from rails or boxy metal housings.

Second-generation missiles, such as the US-designed BGM-71 TOW (adopted in 1970), typically feature reusable launchers and missiles in self-contained launch tubes. These missiles are much easier to use than their predecessors due to the introduction of semi-automatic command to line-of-sight (SACLOS) guidance systems (see Image 5.19). The operator simply has to keep the target in the crosshairs of the weapon’s sight, and the missile does the rest (Fulmer, Jenzen-Jones, and Lyamin, 2016). Some second-generation missiles are wire-guided while others have radio, laser, and optical guidance systems. These missiles often have effective ranges of between 2,500 and 5,500 m with warhead armour penetration of up to 900 mm—almost twice the range and effectiveness of first-generation models (Ness and Williams, 2007, pp. 445–509; Jenzen-Jones, 2017a, pp. 1–2).¹¹⁴

Because the operator of most first- and second-generation ATGMs stays in one location while guiding the missile to the target, they are vulnerable to counter-attack. Some later systems, such as the US-designed FGM-148 Javelin (1996),¹¹⁵ are ‘fire and forget’ weapons, using an advanced suite of electro-optical sensors to store the designated target location and automatically steer the missile to it. Fire and forget systems are often lighter and capable of being broken down into smaller component parts for transportability (Jenzen-Jones, 2017a, p. 2).

113 The term ‘anti-tank guided weapons’ also includes other guided anti-tank systems, such as guided artillery projectiles, guided mortar projectiles, and others (ARES, 2017).

114 Armour penetration is often measured in ‘rolled homogeneous armour equivalency’ (RHAe), which is not directly equivalent to the thickness of a given vehicle’s armour.

115 Currently manufactured by Raytheon/Lockheed Martin. The Javelin was originally developed by a joint venture of Texas Instruments and Martin Marietta (Chait, Long, and Lyons, 2006).

Image 5.19 A Russian 9K135 Kornet-E SACLOS ATGM with 9M133 series missile



Source: Vitaly V. Kuzmin

The latest generation of ATGMs also tend to employ a top-attack profile in which the missile executes a ‘pop-up’ manoeuvre just prior to impact, targeting the top of the vehicle, which is often its weakest point (Jones and Ness, 2013).¹¹⁶ Such systems are capable of hitting targets from long distances; some modern ATGMs have ranges of eight kilometres or more. Recent warhead designs include multipurpose and anti-personnel warheads, and tandem charges to defeat modern vehicle armour (ARES, 2017; Jenzen-Jones, 2017a, pp. 2–3).

Man-portable air defence systems

Man-portable air defence systems (MANPADS) are a class of relatively light-weight, short-range surface-to-air missile (SAM) systems designed to engage low-flying aircraft (ARES, 2017; Jenzen-Jones, 2017b, p. 1; see Image 5.20).¹¹⁷ They are derived from earlier and larger SAM systems conceived during the Second World War. When operated by a crew rather than an individual, these systems are sometimes referred to as crew-portable air defence systems (CREWPADS) (ARES, 2017).

The first MANPADS to be fielded was the US FIM-43 ‘Redeye’, introduced during the Vietnam War (1967). The Redeye was the predecessor of the FIM-92 Stinger, which is famous for its use in Afghanistan in the 1980s (Phillips, 2011). A year later, in 1968, Russia issued the 9K32 Strela-2, known to NATO as the SA-7a Grail. This system and the updated 9K32M Strela-2M (SA-7b) proliferated across the globe in the decades that followed (see Image 5.20) (ARES, 2017).

¹¹⁶ A top-attack profile is sometimes called overfly top-attack (OTA) capability. Top-attack profiles are sometimes used against targets other than vehicles.

¹¹⁷ MANPADS and other short-range SAMs generally have maximum ranges of less than 10,000 m. Medium- and long-range SAMs have maximum ranges more than ten times those of short-range models (Jenzen-Jones, 2017b, p. 3).

Image 5.20 A 9K32M Strela-2M MANPADS and its 9M32M SAM



Source: US Department of Defense

Most MANPADS consist of four main components: a missile in a disposable launch tube, a gripstock, and a battery (see ‘Barrels and launch tubes’ section). The vast majority of these systems are ‘fire and forget’ weapons, meaning that, after the missile is launched, it guides itself to the target with no input from the operator. In most cases, the missile’s seeker detects the infrared energy emitted by the targeted aircraft. Early systems were only effective when fired from behind the aircraft, when the target’s hot engines and airframe are easiest to detect and track. So-called second- and third-generation systems such as the Russian 9K38 Igla (SA-18) are capable of ‘all-aspect’ tracking, meaning that the missile can engage the target from the front, sides, or rear. Some of these systems are able to differentiate between the target and simple countermeasures, such as flares. Later-generation MANPADS are also faster and more manoeuvrable, and have longer ranges and more effective warheads than the older systems (ARES, 2017).

A small number of MANPADS employ other types of guidance systems. These weapons are guided by either radio signals, such as the British Javelin,¹¹⁸ or laser beams, such as the Swedish Bofors RBS 70 (Jenzen-Jones, 2017b).¹¹⁹ MANPADS with infrared seekers are by far the most common, however (PM/WRA, n.d.). Some of the newer models of these systems feature ‘all-target’ warheads, which have a limited capability to engage ground vehicles (Saab, 2016; see Image 5.21).

118 The British Javelin MANPADS is not to be confused with the ATGM of the same name, described in the previous section.

119 Bofors is now part of Saab.

Image 5.21 A Swedish Saab RBS 70 NG CREWPADS firing BOLIDE ‘all-target’ SAM



Source: Saab

Physical features

The physical features of light weapons are much more varied than small arms. Some types of light weapons, such as HMGs and cannon, share many features with small arms, whereas other weapons, including recoilless weapons and mortars, follow wholly different design philosophies and architecture. Broadly speaking, many of the same physical characteristics and markings present on small arms are also present on light weapons. There are some additional considerations, however, which are outlined below.

Bodies and receivers

HMGs and cannon feature what are essentially scaled-up machine gun receivers (ARES, 2017). HMG receivers are unmistakably larger and more robust than their smaller counterparts (see Image 5.22). In many cases, substantial rivets, bolts, and welds are visible (see Image 5.23). The patterns of rivets and welds may prove a useful feature for differentiating between visually similar light weapons, such as the NSV and Kord HMGs.¹²⁰ Most mortars, rocket and missile launchers, and some recoilless weapons do not have a receiver in the conventional sense.

¹²⁰ See, for example, Ferguson (2014c).



Image 5.22 A Browning M2 HMG and its close relative and small arms equivalent, the M1919A6

Note: The M1919A6 (b) is smaller but similar to the Browning M2 (a) in appearance.
Source: Jonathan Ferguson/ARES

Image 5.23 The rear of the receiver of a Romanian copy of a KPV HMG

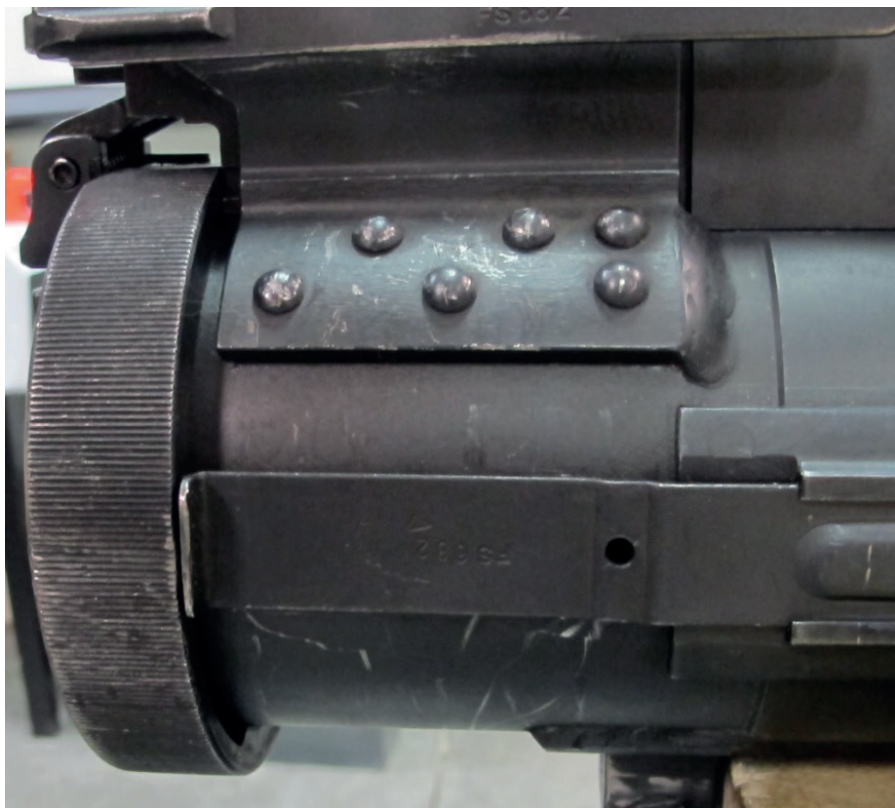

Note: The receiver has a substantial weld and large rivets.
Source: N.R. Jenzen-Jones/ARES

Baseplates

As noted above, most mortar systems consist of a stabilizing baseplate, a barrel, and a bipod. The baseplate transmits recoil forces to the ground or other supporting surface, reducing their effects on the aim of the weapon (see Image 5.24). It is possible that a mortar baseplate might be found in isolation, if the intent is that a position will be reused, or if a mortar team has been disrupted or killed in action. It is worth noting that baseplates may themselves be affixed to concrete floors or vehicle flatbeds.

Image 5.24 The circular baseplate of a British L16 81 mm mortar



Note: The large bipod is used to support and adjust the angle of the barrel, and to provide a mount for the optical sight bracket.

Source: Wikimedia Commons/Hisamikabunomura

Barrels and launch tubes

Although similar in some respects, barrels and launch tubes are distinct components. A barrel is designed to bear significant internal pressures and is sealed at one end to prevent the escape of gas. Launch tubes are not subject to substantial pressures, and act primarily as a guide. Barrels may be rifled or smooth-bore, and light weapons with barrels may be breech- or muzzle-loading (though muzzle-loading is now rare, aside from mortars).

HMGs and cannon generally employ medium-calibre (12.7 mm to >57 mm) rifled barrels that are noticeably larger and heavier than small arms. Barrels for HMGs are likely to be readily detachable, but cannon barrels are not (due to their significant mass and slower rate of fire). Automatic grenade launcher barrels are most often larger in calibre but shorter in length and may be rifled or smooth-bore. Most are not quickly detachable. Barrels for recoilless weapons and mortars are typically more robust than rocket or missile launch tubes, as they are pressure-bearing parts more akin to the barrel of a firearm or artillery piece.

Feed devices

Feed devices for HMGs and cannon are often similar to the feed devices of small arms. Most commonly, these devices consist of a belt-feed system of cartridges in disintegrating or non-disintegrating links that are stored and fed from metal ammunition boxes (see Image 5.25). In some cases, light weapons firing conventional cartridge-based ammunition—including AMRs, light cannon, and grenade

Image 5.25 Examples of belted ammunition

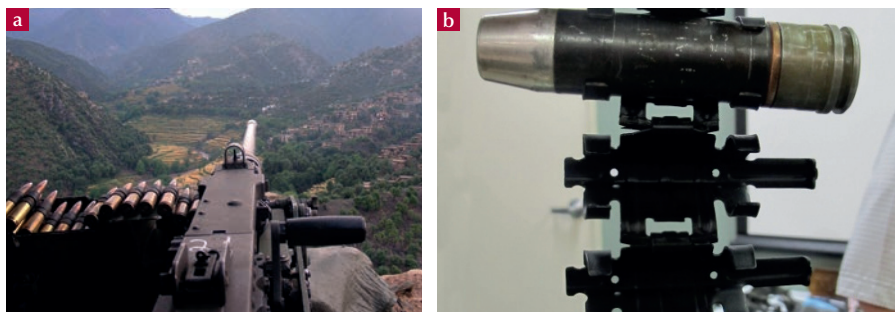

Note: (a) Belted ammunition loaded into a Browning M2 HMG from a metal storage or transit box attached to the weapon's soft-mount. (b) A 30 × 29B cartridge for AGS-17 type grenade launchers loaded into a belt, with two empty links.

Sources: US Department of Defense; N.R. Jenzen-Jones/ARES

launchers—feed from oversized box magazines. Recoilless weapons and rocket launchers are either disposable or reloadable, as described above. Generally speaking, reloadable recoilless weapons and rocket launchers do not feed from external feed devices, although there are exceptions.

Accessories

The range of optional accessories for light weapons is significantly smaller than that for small arms. Some are encountered with optical sights (see Image 5.26), and HMGs and cannon are often found with spare barrels, parts kits, and specialized load-bearing and/or storage equipment for the weapon and its ammunition. These items sometimes help with the identification of an absent weapon.

Image 5.26 An M2 type HMG fitted with various optical sight systems



Source: NIOA

Markings

The patterns and formats of light weapons markings are similar to those on small arms (see Chapter 3), but their format, size, and location are more varied. Like small arms, the markings on most light weapons are stamped or engraved on the receiver and other key components. The information conveyed by the markings often includes the make, model, calibre, production year, and serial number (see Images 5.27–5.30).

Image 5.27 Markings on a Polish DShKM

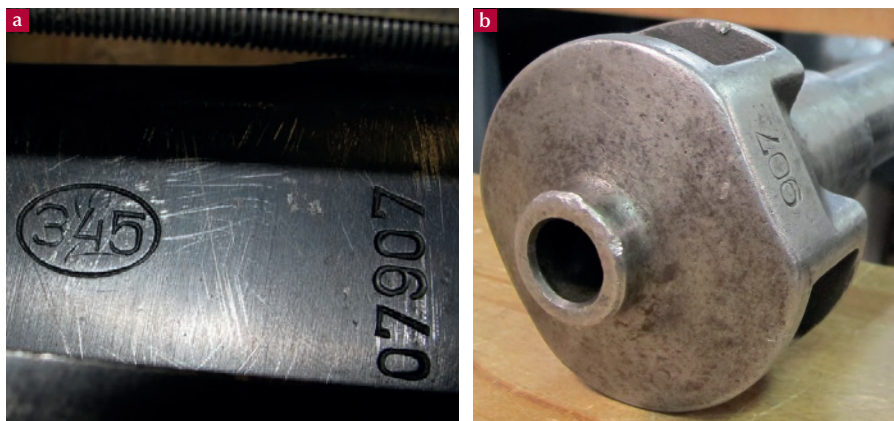

Note: (a) Factory marking, serial number, and inspection mark on a Polish DShKM. (b) Partial serial number (907) reproduced on the muzzle device of the same weapon.

Source: N.R. Jenzen-Jones/ARES

Image 5.28 Markings on a Russian RPG-7V launcher

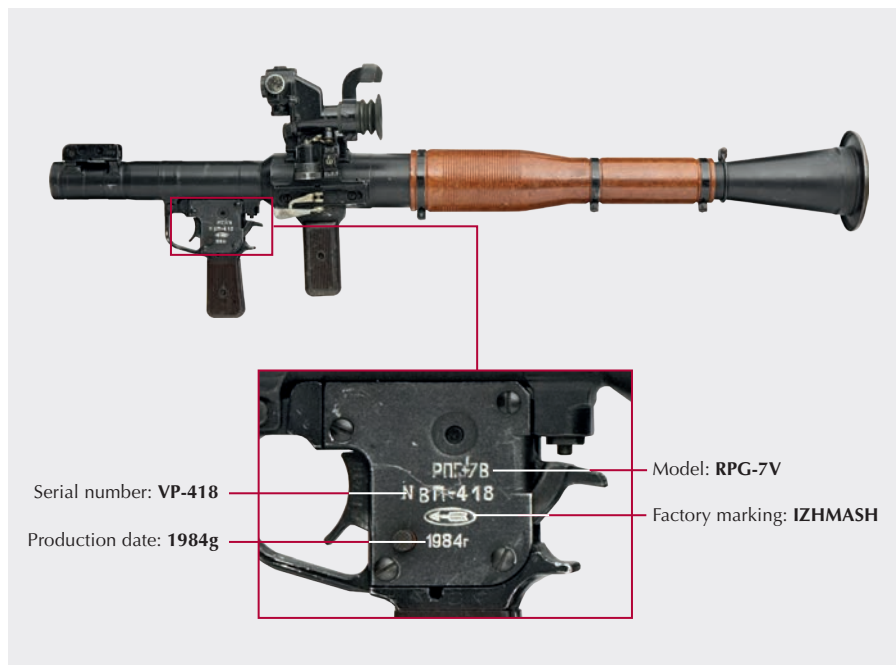

Serial number: **VP-418**

Production date: **1984g**

Model: **RPG-7V**

Factory marking: **IZHMASH**

Source: Small Arms Survey

Image 5.29 Markings on the rear of an M40A1-pattern recoilless gun



Note: The markings reveal several key details such as the type of weapon (CAÑON S/R; for cañon sin retroceso, or 'recoilless gun'), calibre (106MM), model (M40A1), and year of production (AÑO 1973).

Source: Peter Bouckaert/HRW



Image 5.30 A safety/operation warning marked on a Serbian Zastava M93 self-loading crew-served grenade launcher

Note: The warning reads 'ПРВИ ЧЛАНАК НА РЕДЕНИКУ МОРА БИТИ ПРАЗАН', which means 'first link in belt must be empty'.

Source: N.R. Jenzen-Jones/ARES

Some markings are stencilled or hand-painted onto light weapons. This practice is particularly common with regards to MANPADS and ATGW missile tubes, as well as various rocket launchers and recoilless weapons. These items often have additional markings that are stamped or engraved.

Markings on some light weapons are stamped or printed onto a metal plate (see Image 5.31).¹²¹ Such plates, which are riveted or screwed onto a key component, are often easily and untraceably removed. Image 5.32 shows a markings plate on a sighting unit for a US-designed TOW ATGM system.



Image 5.31 Marking plate on a 9P58 gripstock for the 9K32M Strela-2M MANPADS

Source: ARES (n.d.)

Image 5.32 Marking plate on an American Hughes Aircraft Co. TOW ATGM launch unit

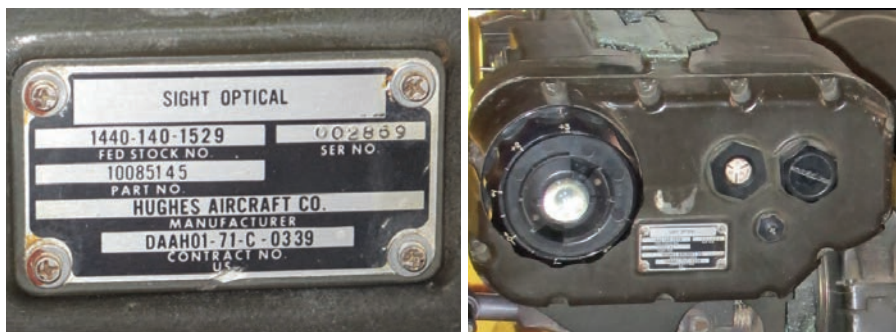

Source: N.R. Jenzen-Jones/ARES

¹²¹ Sometimes called a 'marking plate' or 'data plate'.

Mortar barrels, baseplates, and mounts are sometimes marked, but may also be unmarked, or only have a serial number (see Images 5.33 and 5.34). Additionally, the serial number on the baseplate may not match the number on the barrel. Some marking indicating the model of weapon to which a baseplate or mount belongs is likely, but not present in all cases.

Image 5.33 Markings on the muzzle end of a British L16A2 81 mm mortar barrel



Note: These markings show the calibre (81MM), model/military designation (L16A2), and registration number ('REG №...' partially obscured). The complete markings also include the year of manufacture and other details.

Source: N.R. Jenzen-Jones/ARES



Image 5.34 Fire selector markings (S, F) on a Vektor Y3 crew-served 40 × 53SR mm automatic grenade launcher

Note: The Vektor Y3 is now marketed as the Denel GLI-40.

Source: N.R. Jenzen-Jones/ARES

Ammunition for light weapons

Cartridges for HMGs, anti-tank rifles, and AMRs (20 mm or less)

Ammunition for HMGs is, by definition, small-calibre ammunition (see Chapter 4). Among the most common cartridges in this category are the American 12.7×99 mm, also known as the .50 BMG (Browning Machine Gun), and the Soviet 12.7×108 mm, both of which were fielded prior to the Second World War and remain in widespread service today (Williams, 2000; see Table 5.1 and Image 5.35). While intended primarily for use against armoured vehicles such as tanks, as well as aircraft and other targets, it quickly became apparent that the rapidly increasing thickness of tank armour rendered these rounds ineffective in the anti-armour role. Ammunition for anti-tank rifles (ATRs) and AMRs is often interchangeable with that used by HMGs.¹²² As a result, these weapon systems were subsequently fielded for use against personnel, light structures, unarmoured vehicles, helicopters, and other materiel. HMGs are still widely used against these targets today (ARES, 2017).

Table 5.1 Selected HMG cartridges in military service

Cartridge designation	Country of origin	Projectile type	Projectile weight (g)
12.7×99 mm	United States	API	43
12.7×108 mm	Soviet Union	API	52
14.5×114 mm	Soviet Union	API	64

Note: All figures are approximations and vary according to cartridge type and loading, and other factors.

Sources: Koll (2009); Williams (n.d.; 2000)

¹²² The final generation of ATRs adopted special ammunition. The German and Polish armies chose a small-calibre projectile fired at very high velocity, enabled by a large cartridge case (the 7.9×94 mm Panzerbuchse and 7.92×107 mm Maroszek cartridges, respectively) (Williams, 2000). Other nations developed bigger and much more powerful rounds, particularly the Soviet 14.5×114 mm cartridge as used in the PTRD and PTRS rifles, which towards the end of the Second World War was adopted for use in a large HMG, the KPV, variants and derivatives of which remain in widespread service worldwide (ARES, 2017).

Image 5.35 Some sample cartridges used with HMGs, ATRs, and/or AMRs



Note: (a) 7.62 × 51 mm (for scale); (b) 13 × 92SR mm TuF; (c) 7.9 × 94 mm Panzerbuchse; (d) 12.7 × 99 mm (.50 BMG); (e) 12.7 × 108 mm; and (f) 14.5 × 114 mm.

Source: Anthony G. Williams/ARES

Physical features

Most ammunition for HMGs closely resembles the small-calibre cartridges used in standard infantry rifles and light and general-purpose machine guns, albeit scaled-up considerably (see Chapter 4). These cartridges are commonly produced from drawn brass or steel cartridge cases and typically employ full metal jacket ('ball') bullets, with cores that are usually made of steel. Other commonly encountered functional types includes armour-piercing incendiary (API) rounds and semi-armour-piercing high-explosive incendiary (SAPHEI) rounds. API bullets

normally have hardened steel cores with a small quantity of incendiary material in the jacket tip. Multipurpose SAPHEI bullets have a more complex internal structure, including tungsten alloy penetrators, HE composition, and a jacket nose filled with incendiary material (ARES, 2017; Williams, 2000).

Markings

Ammunition for HMGs and AMRs is typically marked in a manner consistent with other small-calibre ammunition, including the headstamp and tip colour code (see Chapter 4).

Light cannon cartridges (20 mm – <57 mm)

Light cannon fire medium-calibre cartridges. As noted above, these are, in practice, largely restricted to cartridges of 20 mm in calibre (see Table 5.2 and Image 5.36).

Table 5.2 Dominant light cannon cartridges in global military service

Cartridge designation	Country of origin	Sample 'AMR' light cannon	Sample autocannon	Projectile type	Projectile weight (g)
20 × 82 mm / 20 × 83.5 mm	Germany / South Africa	Denel NTW20	Denel GA-1	HE	115
20 × 102 mm	United States	Anzio Ironworks models	Nexter 20M621	HE	101
20 × 110 mm	France	H Alaan RT-20	Hispano- Suiza HS.404	HE	130
20 × 128 mm	Switzerland	None known	Oerlikon KAA	HE	120
20 × 138B mm	Switzerland	Solothurn S18- 1000	Breda Model 35	HE	119
20 × 139 mm	Spain	None known	Rheinmetall Rh 202	HE	120
23 × 152B mm	Soviet Union	Craft-produced AMRs	ZU-23-2	HEI	184

Notes: All figures are approximations and vary according to cartridge type and loading, and other factors. Several of the example autocannon given would not be classified as light weapons, and are provided only for context.

Sources: Hays and Jenzen-Jones (2018); Koll (2009); Williams (2000; 2007)

Image 5.36 Examples of cartridges used with light cannon

Note: (a) 12.7 × 99 mm (for scale); (b) 20 × 83.5 mm (near copy of 20 × 82 mm); (c) 20 × 110 mm; (d) 20 × 102 mm; (e) 20 × 128 mm; (f) 20 × 139 mm; (g) 20 × 138B mm; and (h) 23 × 152B mm.

Source: Anthony G. Williams/ARES

The first issued light cannon, the 20 mm Becker, was introduced by Germany during the First World War. During the Second World War, combatants used a wide range of cannon in different calibres from many manufacturers. Principally, these weapons were employed by or against aircraft, but they were also used in ground fighting roles, particularly when mounted on vehicles (Williams, 2000). In recent decades, there has been a gradual increase in the size and power of light cannon mounted on armoured vehicles, but 20 mm guns remain popular for many purposes (ARES, 2017). As noted above, most cannon are not categorized as light weapons because of their weight.

Traditional light cannon cartridge types include:

- High explosive (HE) and high explosive incendiary (HEI): these cartridges feature a hollow steel projectile filled with high-explosive and, in some cases, incendiary composition (see Image 5.37a).

- Semi-armour-piercing high-explosive (SAPHE) or SAPHEI: these cartridges feature a stronger projectile with a hard point, generally employing a base fuse (see Image 5.37a).
- Armour-piercing (AP, a hardened projectile) and APHC/APCR (armour-piercing hard core (US) or armour-piercing composite, rigid (UK)): a hardened, often tungsten, penetrator within a light alloy body.

HE and HEI types are employed against a range of targets including personnel, light vehicles, structures, and materiel. SAPHE and SAPHEI types are similarly multipurpose in nature, with improved effectiveness against light armoured vehicles and structures. AP and APHC are specifically used against armoured targets, primarily vehicles (ARES, 2017; Williams, 2000).

Light cannon cartridges fielded more recently include armour-piercing discarding sabot (APDS) rounds, which feature hardened, typically tungsten, penetrators, with discarding plastic sabots (see Image 5.37b); frangible armour-

Image 5.37 Selected light cannon ammunition

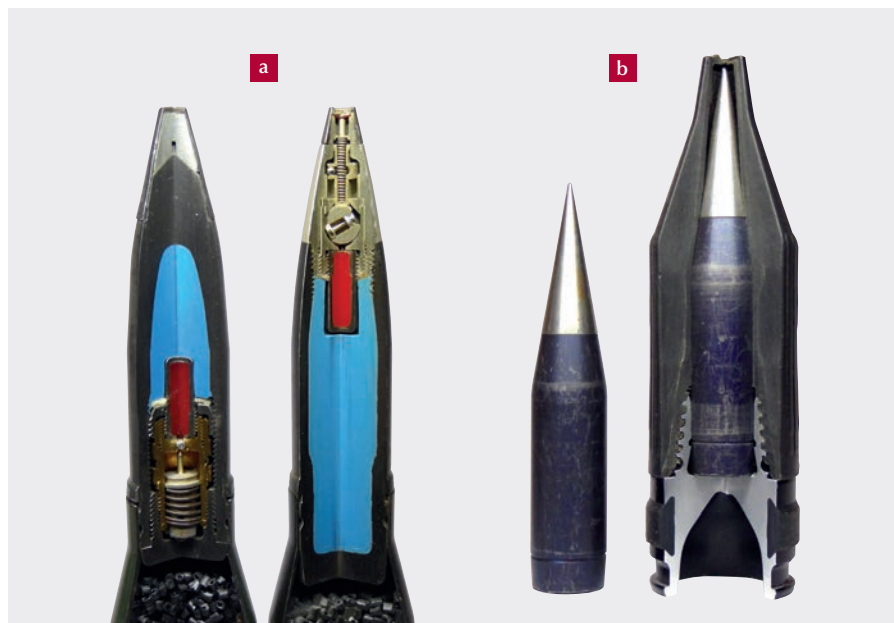

Note: (a) Two sectioned 20 × 128 mm cartridges showing the typical arrangement of SAPHE/SAPHEI (left) and HE/HEI (right) projectiles; (b) A sectioned APDS projectile, with an additional penetrator at left for comparison.

Source: Anthony G. Williams/ARES

piercing (FAP), which have tungsten penetrators designed to break up into high-velocity fragments after penetration; and penetrator with enhanced lateral effect (PELE), also lacking high-explosive contents, and designed to fragment after penetration. These projectiles are typically available in 20 mm cartridges. Larger calibre ammunition features additional types of projectiles (ARES, 2017; Ness and Williams, 2007; Williams, 2000).

Physical features

Most light cannon ammunition is similar to small-calibre ammunition, only larger; however, there are a number of key differences. Cannon projectiles rarely feature a jacket as they have separate driving or rotating bands which engage the barrel rifling to spin the projectile. These bands vary in number, location, material, crimping, and colour, and thus are often useful identification features. Typically, the bands are made of iron, plastic, or copper, and most commonly one or two such bands are present. The number of crimps at the mouth of the cartridge case is another useful diagnostic feature (see Image 5.38) (ARES, 2017; Williams, 2007).

Image 5.38 A Soviet 23 × 152B mm cannon cartridge



Note: This cartridge has double crimping at the case mouth, a copper driving band, and a silver-coloured nose fuse with pink tip marking.

Source: Confidential/ARES

Another notable difference between small-calibre cartridges and many medium-calibre cartridges is the presence of a fuse. In some light cannon ammunition, the fuse will be integral to the projectile and will not be externally visible. In other cases, however, the fuse will be externally visible and may be one of several types available for a given projectile. Fuses will have their own physical characteristics, including their composition, shape, and location. Fuses are generally fitted to the nose of the projectile, but some are located in the base or midsection.¹²³ Most are simple impact fuses, but time and proximity fuses are also in limited use (ARES, 2017; Williams, 2000).

Markings

Light cannon ammunition is typically marked in a similar way to small-calibre ammunition, but often features additional elements. Light cannon cartridges often feature a headstamp and/or case wall marking, as well as a tip colour code. NATO cannon projectiles are painted to reflect their nature. Standard NATO colours include yellow (HE), black (AP), and blue (TP—training/practice), with red bands or lettering to indicate a tracer or incendiary content. Externally visible fuses may also be marked. Russian projectiles are often not painted, and are usually differentiated by physical features (ARES, 2017).

*Grenade launcher cartridges*¹²⁴

As noted above, grenade launchers fire a variety of relatively low-velocity projectiles that are sometimes referred to as ‘projected grenades’ (see Image 5.39).¹²⁵ Early models were of the simple high-explosive type, but high-explosive dual-purpose (HEDP) rounds have become much more common because their shaped-charge warheads are effective against some lightly armoured vehicles while retaining the ability to engage personnel.

123 For more information on types of fuses used with cannon ammunition, see also Dullum et al. (2017).

124 This section does not address cartridges developed primarily for riot control weapons, such as those in 37/38 mm calibre.

125 Grenade launchers typically use a high/low pressure system. The primer in the cartridge ignites the propellant contained within a small high-pressure compartment, from which gas is bled into a low-pressure compartment, accelerating the grenade gradually up the barrel. In some designs, both compartments are contained within the cartridge case; in other, semi-caseless designs the high-pressure compartment is in the base of the projectile, and the low-pressure compartment is essentially the chamber of the launcher (ARES, 2016a; Williams, 2017).

Image 5.39 Some sample cartridges used with grenade launchers



Note: (a) 40 × 46SR mm (40 mm NATO LV); (b) 35 mm DFS10 semi-caseless; (c) 40 mm VOG-25 semi-caseless; (d) 30 × 29B mm; (e) 35 × 32SR mm; and (f) 40 × 53SR mm (40 mm NATO HV).

Source: Anthony G. Williams/ARES

The militaries of NATO member states (and, increasingly, other states) typically employ 40 mm calibre ammunition (see Table 5.3). These rounds are generally divided into two common types: low-velocity (LV) and high-velocity (HV) cartridges. LV cartridges are generally used with under-barrel and shoulder-fired systems, which typically have a range of up to 400 metres. HV cartridges are generally used in belt-fed automatic launchers and have a range of up to 2,200 m (Williams, n.d.). Several companies offer additional types of ‘uprated’ ammunition, including:

- low-velocity extended-range (LV-ER) rounds, which have a range of about 600 metres; and
- medium-velocity (MV) rounds, which fire heavier and higher velocity projectiles out to some 800 metres (Williams, 2017).

LV extended range rounds can generally be fired from under-barrel launchers, while the more powerful MV rounds require a more substantial launcher, such as some six-shot revolver-type grenade launchers (ARES, 2017).

Table 5.3 Selected grenade launcher cartridges in global military service

Cartridge designation	Country of origin	Projectile type	Projectile weight (g)
43 × 30 mm	Russian Federation	Thermobaric	250
40 × 46SR mm	United States	HE	170
40 × 53SR mm	United States	HE	245
40 mm VOG-25	Soviet Union	HE	250
35 × 32SR mm	China (PRC)	HE	240
35 mm DFS10	China (PRC)	HE	170
30 × 29B mm	Soviet Union	HE	280
20 × 42B mm	South Africa	HEI	110
20 × 30B mm	South Korea	HEAB ⁱ	110

Note: All figures are approximations and vary according to cartridge type and loading, and other factors.

ⁱ HEAB stands for 'high-explosive airburst'.

Sources: Jenzen-Jones and Popenker (2015); Poongsan (2016); Yan (2015); Williams (n.d.; 2016; 2017)

In former Warsaw Pact countries, other calibres dominate (see Table 5.3). Low-velocity cartridges for the Soviet/Russian 40 mm VOG-25 and Chinese 35 mm DFS10 are similar in performance to their NATO equivalents, but they are semi-caseless projectiles which are loaded from the muzzle. Both nations use conventional cased rounds for their longer-range HV systems (the Soviet/Russian 30 mm VOG-17 and Chinese 35 mm DF87) (ARES, 2017; Williams, 2017).

Several manufacturers have recently fielded grenade launcher rounds in new calibres and with new capabilities (see Image 5.40). Among the most notable are the programmable airburst rounds for the US XM25 (25 mm) and the Korean K11 (20 mm) weapons (see Box 5.1). Another round worth mentioning is the 43 × 30 mm thermobaric (see Box 5.3) cartridge for the Russian GM-94 grenade launcher. The cartridge is made almost entirely of polymer, which minimizes fragmentation and allows for use at very short ranges during combat in enclosed areas (Jenzen-Jones and Popenker, 2015, p. 7). The South African Denel PM iNkunzi PAW and Strike systems fire 20 × 42B ammunition that consists of standard 20 mm cannon projectiles fired from shorter cases at a subsonic velocity (ARES, 2017; Williams, 2017).

Perhaps the most significant development in ammunition for grenade launchers is the advent of small missiles that can be fired from standard under-barrel $40 \times 46SR$ mm launchers. An example is the laser-guided Raytheon Pike, which has a range of 2,000 m, and was the first guided missile designed to be fired from an under-barrel grenade launcher (Raytheon, 2018; see Image 5.41).

Image 5.40 Examples of recent grenade launcher cartridges



Note: (a) $40 \times 46SR$ mm (40 mm NATO LV; for comparison); (b) $20 \times 30B$ K-11; (c) $20 \times 42B$ iKunzi; (d) $25 \times 40B$ XM25; and (e) 40 mm Balkan semi-caseless.

Source: Anthony G. Williams/ARES

Image 5.41 The Raytheon Pike 40 mm guided missile



Source: Anthony G. Williams/ARES

Box 5.3 Common types of explosive warheads used in light weapons ammunition

At their most basic, explosive warheads are comprised of a fuse, an explosive fill, and a warhead case. Some of the key types of warheads are described below; there are many other more specialized types.¹²⁶

Many light weapons make use of explosive warheads to deliver the desired effects on target. There are three primary ways an explosive weapon can cause damage: through blast, fragmentation, and heat (thermal effects).

High-explosive

High-explosive (HE) warheads are the most common type of warhead for most light weapons ammunition. HE warheads cause damage primarily through the blast wave that they generate, but also through fragmentation and, to a lesser extent, thermal effects. When fragmentation is desired, HE warheads may be constructed with a relatively heavy casing. When the warhead detonates, the casing breaks apart into small pieces, or fragments, which travel at high speeds away from the blast, causing kinetic (impact) damage to whatever they strike. HE warheads are used to engage targets of all types (Cross et al., 2016).

High-explosive fragmentation

High-explosive fragmentation (HE-FRAG) warheads primarily cause damage by generating high-velocity fragments and are employed against personnel and unarmoured vehicles. HE-FRAG warheads may rely on 'natural' fragmentation of warhead materials (which are sometimes brittle, such as cast iron or steel) or include pre-formed fragmentation (for example, steel spheres or cubes). In some cases, a 'fragmentation sleeve' (often a pre-scored piece of metal or a polymer matrix containing pre-formed fragmentation) is attached to the outside of a munition's body (Dullum et al., 2017, pp. 79, 83). Typically, fragmentation warheads use some 30 per cent of the energy from a detonation to disperse fragmentation, with the rest of the energy causing blast effects as described above (NSWC, n.d., p. 8). It is not always readily apparent whether a munition is an HE or HE-FRAG type; different users may classify similar rounds differently.

High-explosive anti-tank

High-explosive anti-tank (HEAT) type ammunition is designed to penetrate armour. Most HEAT warheads are 'shaped charges', meaning they feature a cone-shaped cavity that is lined with a thin metal sheet (typically copper). When the warhead functions, the metal liner collapses into a thin jet that travels at an extremely high velocity. The metal jet 'punches through' armour and penetrates into the target vehicle, causing injury to personnel and damage to the interior of the vehicle. HEAT ammunition is not particularly useful against personnel outside of vehicles since their casings are usually thin and fragmentation is comparatively minimal (Cross et al., 2016, pp. 22–23).

High-explosive dual-purpose

High-explosive dual-purpose (HEDP; sometimes called 'HEAT-FRAG') warheads are designed to provide both anti-armour and anti-personnel effects. Generally, this is achieved by pairing a HEAT warhead with a pre-fragmented (scored) casing or fragmentation sleeve.

Thermobaric

Thermobaric warheads contain certain explosive compositions that exploit oxygen in the air to generate blast effects that last longer than those of conventional explosives; they increase in duration from a few milliseconds to tens of milliseconds. The characteristics of these weapons make them suitable for use against targets in enclosed spaces, such as buildings, caves, or tunnel systems. Thermobaric weapons may be used to ensure sufficient blast effects for lethal use while minimizing or obviating fragmentation (Cross et al., 2016, p. 25).

126 For a basic overview of explosive munitions, see Cross et al. (2016).

Physical features

Ammunition for grenade launchers is designed for low chamber pressures and, as such, has certain distinctive characteristics. The rounds have thin walls and a relatively large explosive capacity, and are often made out of lightweight alloys, such as aluminium. Semi-rimmed (SR) and rimless designs are common. These rounds are generally fed into the grenade launcher via box or drum magazines, or belts. Belted cartridge cases are used with several grenade launchers. Belt-fed cartridges frequently feature projectiles that are larger than their cases, typically with rounded noses (see Figure 5.1).

Fuses are typically located inside the projectile but some impact fuses are fitted to the nose of a projectile. When the fuse is externally visible, its physical characteristics, including its material composition, shape, and where it is located, should be noted.

Figure 5.1 Some of the key physical features of grenade launcher ammunition



Note: In this case, the ammunition is a US 40 × 46SR mm M406 HE model.

Source: Jim Geibel via ARES

Some grenade launcher projectiles feature driving or rotating bands, which can serve as a useful identification feature, based on their location, material, crimping, and colour (see Image 5.42).

Other types of ammunition for grenade launchers include illumination and signal flares, smoke, anti-personnel, thermobaric, and less-lethal impact and riot control agent (RCA) rounds. Many are distinguishable by their physical features. Less-lethal impact rounds, for example, often have a spongy projectile, while most illumination cartridges have a substantially greater overall length than high-explosive rounds. Similarly, anti-personnel rounds often look like large metal-cased shotgun cartridges (ARES, 2017; Williams, n.d.).

Image 5.42 Two US M385 40 × 53SR mm practice cartridges in links, as used with belt-fed grenade launchers such as the MK 19 series



Note: This image shows the copper driving bands, different coloured metal finishes, and markings.

Source: Drake Watkins/ARES

Markings

Markings on grenade launcher ammunition, which are often stencilled, typically identify the manufacturer, functional type, year of production, and/or the lot or batch number (see Figure 5.2). While projectiles are frequently marked with an identifying colour scheme, manufacturers and users use a number of different formats. Some rounds have headstamps and/or additional markings on the cartridge case. Fuses also usually feature their own markings.

Figure 5.2 Sample markings on a Bulgarian Arsenal RLV-HEF-1 40 × 46SR mm HE-FRAG cartridge



Bulgarian GLV-HEF

GLV-HEF

Projectile model designation

['double-circle-ten' symbol]-01-12

Manufacturer code (Arsenal JSCo., Bulgaria) – lot number – year of production (2012) (for projectile)

40×46 mm

Calibre (40 × 46SR mm)

RLV-HEF

Cartridge model designation

['double-circle-ten' symbol]-01-12

Manufacturer code (Arsenal JSCo., Bulgaria) – lot number – year of production (2012) (for completed cartridge)

Source: Arsenal JSCo via ARES (n.d.)

Light and medium mortar projectiles

Mortar projectiles are traditionally simple designs that are very cheap to manufacture. They typically consist of a projectile, ignition cartridge, and (optionally) one or more auxiliary charges (see Figure 5.3). Most high-explosive rounds have cast iron or cast steel bodies, high-explosive fillings, and simple impact fuses (Jenzen-Jones and Paunila, 2017).¹²⁷ Other commonly available mortar projectile types include smoke (including white phosphorus), illumination, TP, incendiary,¹²⁸ guided, and cluster munitions. Guided projectiles are usually readily identified by complex, movable control surface assemblies and advanced fuses (see Image 5.43) (Dullum et al., 2017; ARES, 2017).

The typical mortar projectile is fitted with an ignition cartridge (sometimes known as a 'base charge' or 'propelling cartridge') that is either integral to the round or removable. The ignition charge features a primer similar to those used in small-calibre cartridges. The primer is located inside the tail of the round. When the round is dropped down the mortar tube, the firing pin at the bottom

Figure 5.3 Arrangement of a typical mortar projectile

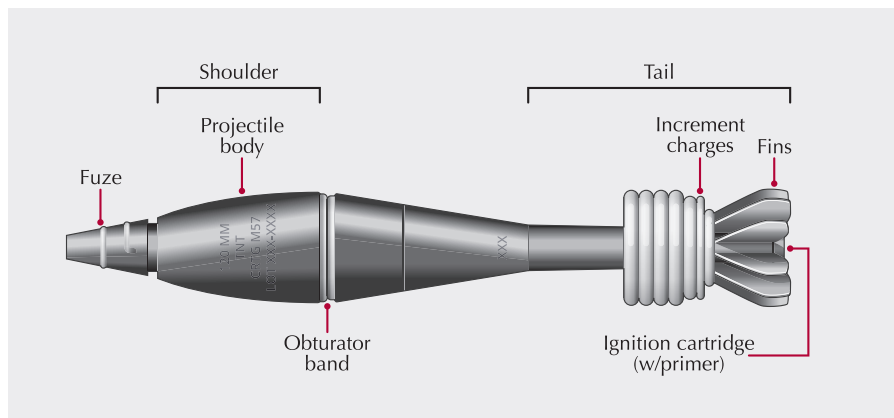

Adapted from: US Department of Defense (2007)

¹²⁷ In some cases, forged steel bodies are used; however, cast metals tend to produce more effective fragmentation for anti-personnel purposes (Jenzen-Jones and Paunila, 2017).

¹²⁸ Incendiary weapons cause primary and secondary fires to destroy materiel. Incendiary ammunition for light weapons typically use solid incendiary compositions such as thermite, magnesium, and/or white phosphorus. Traditional liquid incendiary fills such as napalm or kerosene are generally not used in light weapons ammunition.

Image 5.43 XM395 precision guided mortar projectile



Source: Anthony G. Williams/ARES

of the tube impacts the ignition cartridge, detonating the primer, which ignites the propellant (Dullum et al., 2017). The expanding gases generated by the burning propellant push the projectile out of the tube and towards the target.

In some designs, the ignition charge alone can propel the projectile at a low velocity and is suitable for engaging targets at very close ranges. For longer range targets, the operator affixes a number of ring-shaped propellant charges to the projectile (Dullum et al., 2017, p. 28). These charges, which are called 'increments', 'propelling charges', 'auxiliary charges', or 'augmenting charges', are commonly attached to the tail of modern mortar projectiles, and to the fins of older rounds.

Recent improvements to mortar rounds include better materials, more aerodynamic designs (to achieve longer ranges), and more sophisticated fuses.¹²⁹ GPS conversion kits for 120 mm rounds are now available, and kits for light and medium mortar calibres are likely to follow. Purpose-designed guided mortar bombs have also been developed in 81 mm, with 60 mm likely to be fielded in the near future (Jenzen-Jones, 2015b; Williams, 2016).

129 The improvements to materials include bodies designed for more efficient fragmentation, the addition of pre-formed fragments, and the use of insensitive explosive fillings. See, for example, Williams (2016).

Physical features

The typical mortar projectile is widest behind the shoulder of the body and at the tail. Mortar projectiles must be slightly narrower in diameter than the bore of the weapon from which they are fired. They, however, also need to block some of the gas produced by the propelling charge, because if this escapes past the body of the projectile it reduces its range (ARES, 2017). The most common way of preventing these gases from escaping is to employ a series of ‘gas check’ bands that are cast or machined into the body. Some mortar projectiles are fitted with an obturator band (or obturating ring) instead of gas check bands. Obturator bands are often made of hard nylon (Jenzen-Jones and Paunila, 2017, p. 28). The number, location, and character of gas check or obturator bands are a key physical identification feature.

The functional type of a mortar projectile can often be determined from its physical features. For example, many cargo (carrier) projectiles, such as certain smoke and illumination types, have a greater overall length, and a more cylindrical shape than conventional HE types (see Image 5.44). Mortar projectiles are almost invariably fitted with a nose fuse.¹³⁰ Fuses have their own physical characteristics, including distinctive shapes and components. Increment charges should also be documented since their composition, shape, type, and colour are often useful for identification purposes.

Image 5.44 A range of 60 mm, 81 mm, and 120 mm mortar projectiles



Note: 60 mm projectiles (L-R: smoke, HE, illumination) at left; 81 mm (L-R: illumination, smoke, HE) in foreground (all sectioned); and 120 mm projectiles (L-R: HE, smoke, illumination) at rear. Increment charges are present on all examples.

Source: Anthony G. Williams/ARES

¹³⁰ Most mortar rounds have impact fuses, but some have time or proximity fuses. Increasingly, multifunction fuses are being employed.

Markings

Mortar projectiles, like many other types of large-calibre ammunition, are typically painted in accordance with a specific colour marking scheme, often to indicate different functional types. Different armed forces and manufacturers use different colour schemes. The US colour marking scheme, which is similar to the scheme used by many NATO states and other allies, is presented in Box 5.4 (ARES, n.d.). Information about the functional type of the projectile is normally stenciled on the body. Other markings that indicate the manufacturer, year of production, and lot or batch number may also be present (see Image 5.45). Ignition cartridges, fuses, and increment charges may also be marked. Ignition cartridges (see Image 5.46) often have a headstamp visible at the base of the projectile. Fuses are generally marked to indicate model or type, and often bear other markings as well.

Image 5.45 Markings on a British L19A2 white phosphorous (WP) smoke 81 mm mortar projectile



Note: There is a colour-coded body, obturating band, and differing stamped and stenciled (painted) markings.

Source: Peter Bouckaert/HRW

Image 5.46 Markings on various ignition cartridges



Note: (a) Plastic body; (b) and (c) sealant-impregnated cardboard/paper bodies.

Source: Diehl and Jenzen-Jones (2012)

Box 5.4 US ammunition marking colour scheme

Munitions are painted primarily to inhibit the formation of rust, identify the functional type of the ammunition, serve as camouflage, or identify hazardous fillers. Some of the more common marking colours are presented in Table 5.4 (US DoD, 2009). It is important to note that schemes may be combined with a camouflage colour (typically olive drab) or other marking colours to indicate additional effects (for example, incendiary).¹³¹

Generally speaking, the US colour marking scheme outlined in Table 5.4 applies to ammunition in US service which is larger than 20 mm in calibre. US allies often use the same or similar marking schemes. While marking colour schemes provide important information about the round, it is important to identify ammunition by assessing physical features and markings as well.

Table 5.4 Selected marking colours on US ammunition

Colour	Ammunition type
Olive drab	No significance (camouflage purposes)
Yellow	High explosive
Brown	Low explosive
Grey	Chemical
Light green	Smoke
Light red	Incendiary
White	Illuminating (pyrotechnic)
Black	Armour-defeating
Aluminium (silver)	Countermeasure

Source: US DoD (2009)

¹³¹ For an expanded list, including details regarding the specific colouration of markings on the body, text, coloured bands, etc., see US DoD (2009).

Recoilless weapon projectiles

Projectiles for recoilless weapons vary significantly. This variation reflects:

- differences in the design and operation of reloadable versus disposable recoilless weapons;
- their many and varied battlefield roles; and
- developments in technology.

While the most common projectile types are high explosive (HE) and high explosive anti-tank (HEAT), a wide range are produced (ARES, 2017).

Recoilless weapons were primarily intended for use against tanks and other heavily armoured vehicles; rounds with warheads designed to penetrate armour (HEAT types) are therefore most common. Other projectiles are designed for use against personnel (HE/HE-FRAG), and buildings and other concrete structures (often known as anti-structure munition (ASM), and multipurpose (MP) warheads) (ARES, 2017).¹³² Several ASM/MP warheads are able to penetrate walls before detonating inside a building. More advanced variants of both HEAT and ASM rounds have tandem warheads: the initial warhead blows a hole in the wall or armour, through which a second warhead enters the target before detonating.¹³³ Some recoilless weapons are able to fire a wide variety of ammunition types (see Image 5.47).

Some recoilless weapons fire conventional cartridge-based ammunition, while others use ammunition more similar in form to mortar projectiles or rockets. Rocket-assisted projectiles (RAPs), particularly those fired from disposable shoulder-fired systems, are sometimes readily confused with 'true' rockets, for example. Some recoilless projectiles feature an ignition cartridge and auxiliary charges similar to those used in mortar projectiles (ARES, 2017). Other types, particularly RAPs such as those fired from the RPG-7 series of weapons, are fitted with a type of propellant charge known as an expelling charge. This charge, which is fitted to the munition before it is fired (see Image 5.48), expels the projectile from the barrel of the weapon. When the projectile is a safe distance from the operator, a sustainer rocket motor ignites and propels the projectile towards the target (Jenzen-Jones, 2015c).

¹³² Multipurpose types are sometimes known as 'multi-target' (MT).

¹³³ See, for example, Warwick (2008).

Image 5.47 A range of cartridges produced for use with the Carl-Gustaf shoulder-fired 84 mm recoilless weapon



Note: (a) HEDP; (b) ASM; (c) multi-target (MT—a term sometimes used instead of multipurpose); (d) HEAT; (e) tandem HEAT; (f) HEAT; (g) TP; (h) smoke; (i) illumination; (j) anti-personnel (APERS); (k) HE; and (l) training/practice-tracer (TPT). Some cases are marked to indicate RAPs.

Source: Anthony G. Williams/ARES

Image 5.48 Bulgarian PG-7 projectiles in the process of being assembled



Note: The image shows the expelling charge cases (see also Image 5.53), thread protectors, and other packaging.

Source: Confidential/ARES

When a recoilless weapon is fired, high-velocity exhaust gases exit the weapon from the rear of the gun. The energy generated by these gases must be released in order to counteract the recoil of firing the weapon. The gases, which are often readily observable by the enemy as they kick up dust and debris, can injure personnel and damage objects behind the weapon; such weapons cannot therefore be fired from inside enclosed spaces. To overcome this issue, some recoilless weapons expel a liquid, shredded material, or powder instead of high-pressure gas. These weapons are generally known as confined space (CS) variants because they can be used in confined spaces (the user can fire the weapon out of a window from inside a room, for example) (ARES, 2017; Jenzen-Jones, 2015c). Some of these systems may leave evidence of their firing on the battlefield in the form of the expelled material.

Physical features

Some recoilless weapons fire cartridge-based ammunition similar in form to other cartridges, including small-calibre ammunition. These rounds often comprise a cartridge case, projectile, primer, and other features seen on other cartridge-based ammunition. Case type, case shape, and case and projectile composition should all be noted.

A careful examination of a recoilless projectile's physical features can often reveal much about the projectile. Certain projectiles with tandem warheads, for example, are readily distinguishable from conventional high-explosive types by their distinctive profile (see Image 5.49). Driving and rotating bands on some recoilless projectiles also serve as useful identification features. The location, material, crimping, and colour of these bands varies from model to model. Most commonly these bands are made of copper, iron, or plastic.

Propellant charges, including expelling charges, may also be encountered and can often be used to identify a model of weapon in the absence of other evidence. For example, the propelling charge in Image 5.50 would suggest the RPO series of recoilless projectiles, which is commonly encountered in certain conflict zones.

Recoilless projectiles are frequently fitted with an externally-visible fuse in the nose of the projectile, most commonly an impact fuse, but occasionally a time or proximity fuse. Fuses have their own distinctive physical characteristics, including where they are located on the weapon, their material composition, and their shape.

Some types of recoilless projectiles are difficult to distinguish from other types of ammunition, such as mortar projectiles and rockets. Certain Eastern Bloc recoilless projectiles, for example, closely resemble mortar projectiles (see Image 5.49). Similarly, some recoilless projectiles fired from disposable, shoulder-fired weapons share physical characteristics with rockets fired from similar weapons (see Image 5.50). Finally, certain recoilless projectiles can be fired from vehicle-mounted launchers, with only minor modifications.¹³⁴

Image 5.49 Soviet BK-881M type 82 mm recoilless HEAT projectile



Source: US Department of Defense

Image 5.50 An early Soviet RPO-A shoulder-fired 93 mm recoilless weapon showing the projectile and distinctive propelling charge below the gun



Source: Wikimedia Commons/Magapixie

¹³⁴ For example, some recoilless projectiles fired from light weapons such as the SPG-9 are identical or nearly identical in form and function to those fired from smooth-bore 73 mm guns fitted to armoured vehicles, such as the 2A28 Grom. In some cases, the same projectile may be fitted with different expelling charges depending on the weapon it is being fired from (IDA, 1995).

Markings

Markings on recoilless projectiles often reveal the functional type, manufacturer, year of production, and the lot or batch number (see Image 5.51 and 5.52). The markings on the body of the projectile are often stencilled. The colour of these markings often indicates the functional type of the projectile. Fuses are generally marked in a similar way to indicate mode or type. Expelling charges, ignition cartridges, and increment charges may also feature markings indicating their model, type, propellant, year of production, and other details (see Box 5.5).

Image 5.51 Markings on a Bulgarian PG-7M projectile for the RPG-7 series of shoulder-fired recoilless weapons

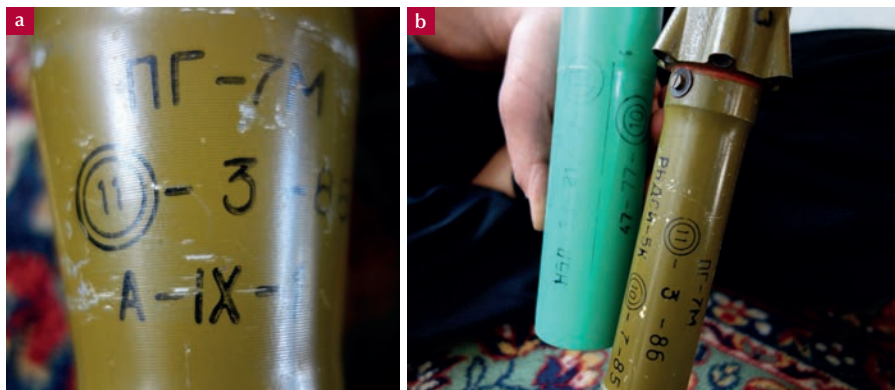

Note: (a) Markings in this case include the designation ('PG-7M'), factory code ('double-circle 11'), lot number ('3'), year of production ('86'), and composition of the explosive fill ('A-IX-1'). (b) Further markings on the same projectile with information about the projectile and the rocket motor which assists in accelerating it. Markings are also visible on the PG-7P expelling charge (left), in a similar format.

Source: C.J. Chivers/*The New York Times*



Image 5.52 Markings on the base of a 106 mm HESH cartridge case

Note: There are three distinct sets of markings: a 'conventional' head-stamp, stamped into the material of the cartridge case itself; painted markings giving the most critical data; and markings stamped onto the primer.

Source: Confidential/ARES

Box 5.5 RPG-7 projectile designations

Projectiles designed by producers in the Soviet Union, the Russian Federation, and many other former Eastern Bloc countries typically have a 'V' in the designation (for example, PG-7V, PG-7VR, etc.); this stands for *vystrel*, or 'round', which refers to the combination of the projectile and the expelling charge.¹³⁵ The expelling charge, sometimes referred to as a 'booster section', launches the projectile out of the barrel. When the projectile is at a safe distance from the operator, the rocket sustainer motor kicks in, accelerating the projectile towards its maximum velocity. Hence 'PG-7', refers specifically to the projectile alone, while 'PG-7V' refers to the round in its entirety including the expelling charge (in this case, PG-7P, see Image 5.53), whether assembled or not (Jenzen-Jones, 2012b).

Image 5.53 PG-7P expelling charges for the RPG-7 shoulder-fired recoilless weapon



Note: Markings indicate manufacturer, date of production, lot number, and other details.

Source: Confidential/ARES

Unguided rockets

Rockets vary significantly in size, range, technological sophistication, and role. In its simplest form, a rocket consists of a tube in which fuel is burned, with an opening at one end. The escaping gases cause an equal and opposite reaction on the closed end of the tube, propelling the rocket forwards (Ryan, 1982).

Rockets in common usage are either spin-stabilized or fin-stabilized. Spin-stabilized rockets are generally of a shorter overall length than their fin-stabilized counterparts. Spin is achieved through a series of obliquely-mounted nozzles placed off-centre at the rear end of the rocket. Fin-stabilized rockets also rotate

¹³⁵ In other ammunition types, components of a 'round' may also include propellant, cases, wadding, and/or other items.

Figure 5.4 Arrangement of a typical fin-stabilized rocket

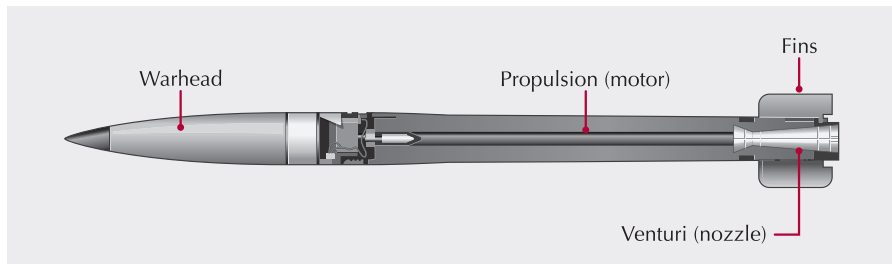

Adapted from: Dullum (2009)

but at a much slower rate (only a few revolutions per second). Most fin-stabilized rocket designs feature wrap-around or fold-out ('pop-out') fins which deploy a few metres after launch (Dullum et al., 2017, p. 31; see Figure 5.4). Unguided rockets are sometimes known as free-flight rockets (FFR). There are a wide variety of warheads for rockets, although HEAT, HE, and cargo types are most common.¹³⁶

Physical features

For identification purposes, the key features of rockets include the following:

- The general dimensions, especially the diameter at the widest point of the body.
- Visible seams between the warhead and motor sections.
- Size, type, and number of fins.
- Rivets, bolts, welds, or other joining features.
- General profile of nose ogive.
- Visible exhaust ports (venturi) and other protrusions.

All of these features should be examined and recorded.

Externally-visible fuses are another important feature. Rockets have impact, time, or proximity fuses depending on their functional type and purpose. Some multifunction fuses are in service. Fuses have their own physical characteristics, including their composition and shape, and location.

¹³⁶ Cargo munitions carry their payload to the target location and then control its dispersal. Cargo warheads may carry submunitions (which can themselves be HE, HEI, HEDP, etc. types), illumination candles, smoke units, propaganda leaflets, or other payloads. Cargo munitions most often use a time fuse.

Markings

Markings on rockets are often stencilled on the side of the body. The markings often identify the make, model, and type of rocket, as well as the year of production, lot or batch number, and safety information (see Image 5.54). Some rockets are marked in a certain colour to indicate functional type. Fuses, where present, will generally be marked to indicate model or type, and often bear other markings as well.

Guided missiles

As noted above, there are two primary and very different families of guided missiles fired from light weapons, which are employed for different battlefield roles: anti-armour or anti-aircraft. Anti-aircraft missiles (known as MANPADS when light weapons) have a much harder task, needing to accelerate to super-

Image 5.54 Markings on an Iranian 107 mm rocket and another rocket's inner packaging



Note: The markings identify the type of round (HEI), diameter (107 mm), date of production (2007), lot number (6), net weight (19.250 kg), and registration numbers (0185 and 186). Note also the distinctive colour markings, including the red band signalling an incendiary fill.

Source: Israel Defense Forces

sonic velocity quickly in order to hit very fast-moving targets. Wire guidance is not an option. Manual radio guidance has been tried but proved unsatisfactory in combat. Most MANPADS rely on infrared seekers.

The earliest ATGMs were low-speed rockets guided manually through wires which unwound from the missile as it flew. Since then, ATGMs have become significantly more sophisticated, with guidance systems that only require the operator to keep the sights trained on the target (the missile automatically follows the line of sight). Increasingly, ATGMs use wireless communication to transmit guidance commands. Some missiles are designed to fly a couple of metres above the line of sight and fire their warheads at a downwards angle to penetrate the much thinner top armour of armoured fighting vehicles. ATGMs most commonly feature HEAT warheads; however, so-called anti-structure munition (ASM) and multipurpose (MP) warheads are increasingly being introduced (ARES, 2017).

Physical features

Guided missiles are typically rather easy to identify. There are a relatively small number of systems in existence and most have a distinctive appearance. While the specific make and model are not always readily apparent, the pattern and capability of a weapon can usually be easily determined. Many ATGMs and MANPADS are readily distinguishable from other types of light weapons and from other guided missiles, due to their particular shapes and sizes, and frequently clear markings. Most portable guided missiles are contained within launch tubes which protect them while in transit and storage. ATGMs and their launch tubes tend to be comparatively short and fat, whereas MANPADS need to have a small (aerodynamic) frontal area to achieve high speeds, and so are relatively long and slim. Fins, most of which either fold out or wrap around the missile body, vary substantially from model to model; this makes them useful for identification purposes.

Markings

Markings on missiles for MANPADS and ATGMs are often stencilled on the side of both the missile and the launch tube. Markings usually indicate the make, model, and type of missile, as well as the year of production and lot or batch number (see Image 5.55 and Figure 5.5). Many missiles are also marked with a unique serial number, which can be particularly useful for tracing purposes.



Image 5.55 Examples of markings on ATGMs

Note: (a) Russian 9M131 missile for the 9K115 Metis (AT-7) ATGW. (b) Markings on a 9M14M Malyutka ATGM.
Source: Peter Bouckaert/HRW

Figure 5.5 Markings on a Russian 9M113 Konkurs ATGM

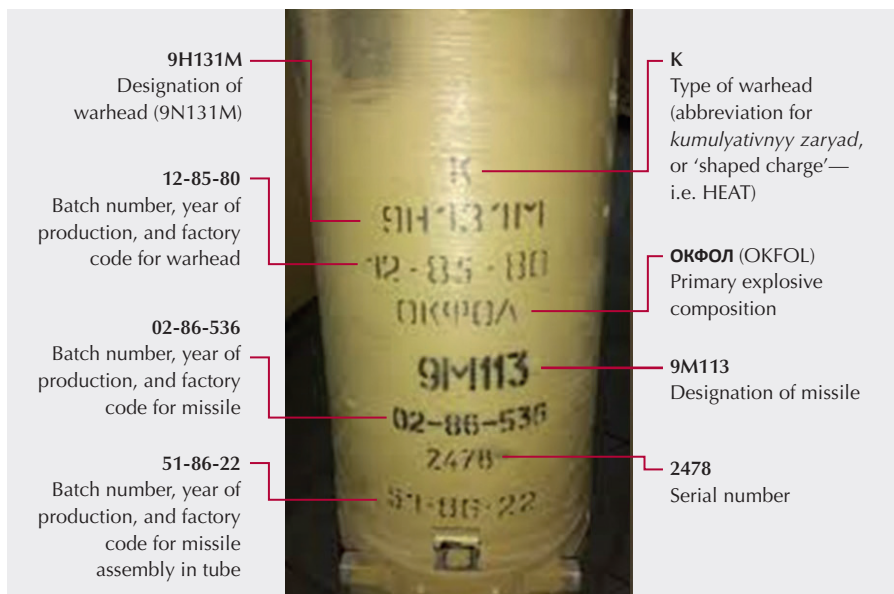

Source: Fulmer, Jenzen-Jones, and Lyamin (2016)

Packaging and documentation

As with small arms, many light weapons are encountered in the field with packaging and, to a lesser extent, documentation. There are two types of packaging: outer packaging and inner packaging. Outer packaging typically consists of wooden or plastic shipping crates (see Image 5.56) or plastic or metal storage containers. Inner packaging includes storage tubes, plastic packaging, and grease-proof paper.



Image 5.56 External packaging crates and internal packaging tins containing Russian 14.5 × 114 mm B-32 API cartridges produced in 1989

Source: ARES (n.d.)

Packaging often provides valuable clues as to the origin, date and place of production, and type of the arms in question (see Figure 5.6).

Packaging may also reveal the destination, ports of transit, dates of transfer, and other important information about the transfer and chain of custody of the weapon. Image 5.57, for example, shows a crate with markings indicating the intended port of delivery ('Tripoli, L.A.R.'), unique case number ('Case No. 695'), and total number of cases ('No of Cases: 16667').

Figure 5.6 Markings on outer packaging for a Russian 9M113 Konkurs ATGM

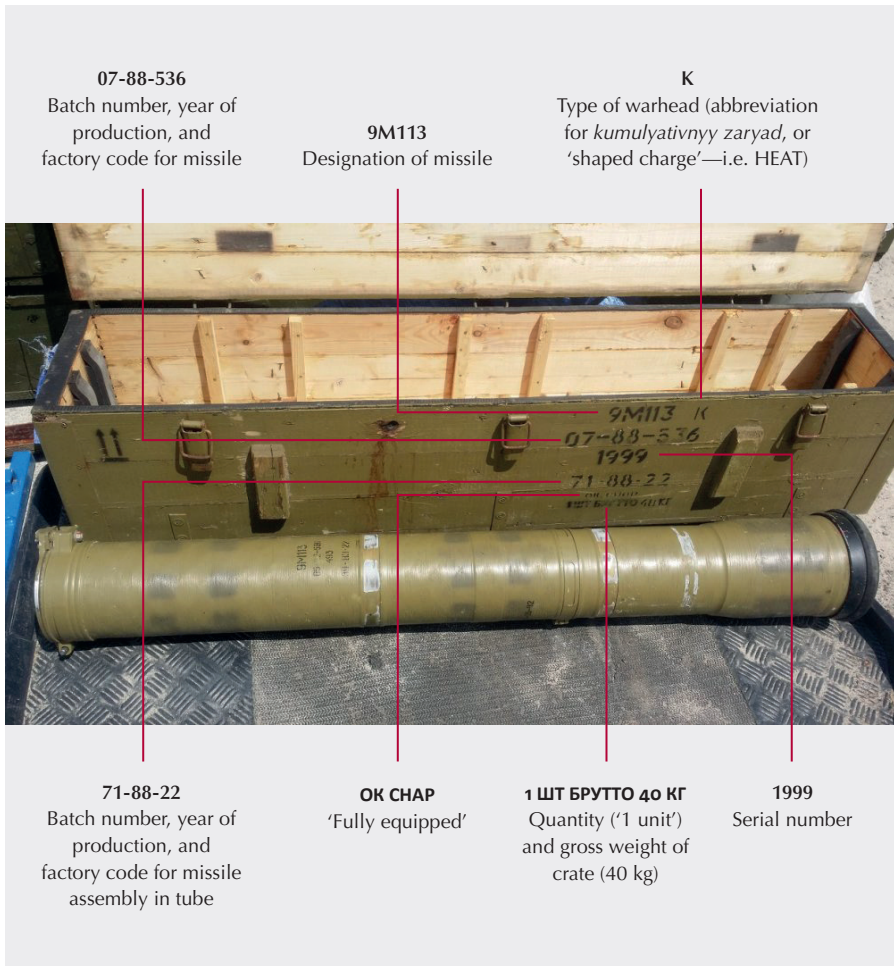

Source: Fulmer, Jenzen-Jones, and Lyamin (2016)

Image 5.57 External packaging containing Yugoslavian M72 81 mm mortar projectiles with fuses



Source: Peter Bouckaert/HRW

Image 5.58 Packing list attached to the inside of a wooden crate containing Russian PG-7 projectiles and PG-7P expelling charges



Source: Confidential/ARES

Image 5.59 Deliberately mislabelled crate marked 'Parts of bulldozer', actually containing an artillery rocket manufactured in North Korea



Source: Peter Bouckaert/HRW

Crates of illicitly-exported weapons are sometimes deliberately mislabelled to conceal their actual contents. Image 5.59 shows a packaging crate labelled 'Parts of bulldozer' that actually contained a rocket. The crate was exported to Libya in violation of a UN embargo on arms transfers from North Korea. Mislabelling weapons crates is a common practice among traffickers of North Korean weapons and arms exporters located in other embargoed countries (Jenzen-Jones and Noakes, forthcoming).

Packaging for light weapons ammunition is often very useful for identification purposes, particularly when the ammunition (or the corresponding weapon) is no longer present. Most packaging follows the pattern established for small arms ammunition, though due to the size and robust nature of most light weapons ammunition, these items are often packaged in sturdier crates. Some more expensive, comparatively delicate types of ammunition, such as missiles, are packaged in containers with padding or other protective material.

Some types of ammunition are frequently found belted or otherwise ready for immediate use. For example, 40 × 53SR mm projectiles are almost exclusively fired from belt-fed AGLs and so typically come linked together. Many guided missiles are similarly provided ready to fire, and packaging containing such ammunition may be marked with 'fully equipped', 'completely loaded', or similar wording (see Figure 5.6 and Image 5.60). Projectiles and expelling charges for the RPG-7

Image 5.60 Wooden outer packaging (shipping crate) containing two 9M32M type MANPADS



Source: Peter Bouckaert/HRW

Image 5.61 Markings on a Bulgarian PG-9P expelling charge for projectiles fired from the SPG-9 recoilless gun



Source: Peter Bouckaert/HRW

and similar weapons are frequently unpacked, assembled, and carried as complete rounds, and thus the potentially useful packaging is often left elsewhere (see Image 5.48 and 5.61).

It is also important to note that smaller, seemingly inconsequential items, such as expelling charge cases and warhead thread protectors for RPG-7 rounds, may be left behind by operators who systematically collect other evidence. These operators may be unaware of the potential utility of these items for identifying weapons and ammunition. Such items are particularly important where light weapons are uncommon, for example in a domestic law enforcement environment; in conflict zones they may be so numerous that they are of comparatively limited use.

Documentation is one of the finest sources of information uncovered in

the field. Import, export, or in-country transfer documentation often reveals key information not only about individual weapons but also about the shipments of which they were a part. This information includes contract dates, order quantities, ports of transfer, and country of origin (see Figure 5.7 and Image 5.58).

Figure 5.7 Delivery documentation (packing list) for 9P135M-1 ATGW launchers delivered to Libya in the late 1980s

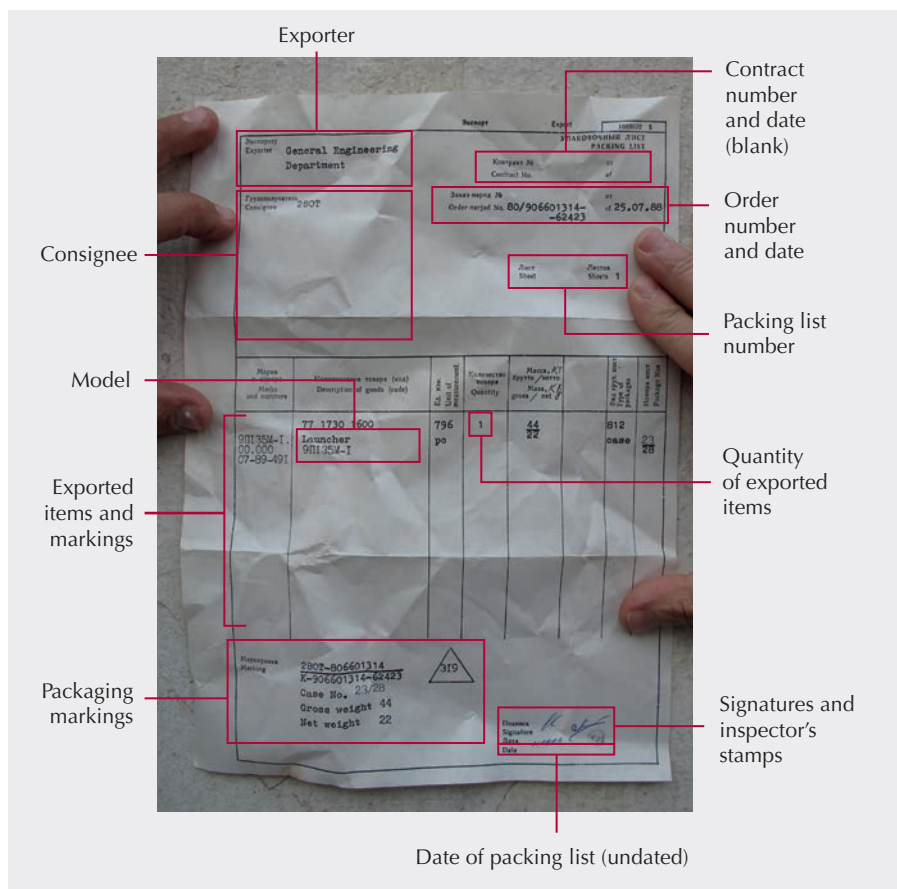

Note: The authors of the document have used deliberately vague details.
 Source: Confidential via ARES

— **Authors: N.R. Jenzen-Jones with Jonathan Ferguson and Anthony G. Williams**

CHAPTER 6

Weapons Identification: Other Small Arms and Light Weapons

Introduction

This chapter examines various types of small arms and light weapons that differ from conventional, modern examples. It begins with an overview of improvised and craft-produced small arms and light weapons, including the various sub-categories of these weapons. The chapter then examines the capabilities of improvised and craft-produced weapons and explores various means of identification. It goes on to present an overview of converted and reactivated arms, and of improvised and craft-produced ammunition. Finally, the chapter sets out the main characteristics of muzzle-loading firearms.

Improvised and craft-produced weapons¹³⁷

Improvised and craft-produced small arms and light weapons comprise a sizable percentage of weapons seized in domestic law enforcement operations in many countries, and have appeared in numerous conflict zones. Consequently, it is important for journalists and researchers to have a solid understanding of these weapons and how to identify and track them. They are commonly acquired and used by individuals, criminal gangs, and insurgent groups when commercial alternatives are not available. They vary in sophistication and quality from crude, improvised, single-shot guns to semi-professionally manufactured copies of conventional firearms. While craft producers are not manufacturing advanced guided light weapons, such as man-portable air defence systems (MANPADS) or anti-tank guided weapons (ATGW), other types of light weapons are produced with some regularity. These weapons include mortars, anti-materiel rifles, recoilless guns, and grenade launchers.

Many craft-produced and improvised weapons offer illicit users the added advantage of being difficult to trace. A lack of registration, misleading or absent markings, and an unusual forensic profile impede or obviate the various methods for tracing illicit small arms and light weapons commonly employed by authorities. Most improvised weapons have no serial numbers or other markings used to identify and trace their factory-built counterparts, and few, if any, are registered

¹³⁷ This section draws extensively upon the Small Arms Survey report *Beyond State Control: A Guide to Improvised and Craft-produced Small Arms and Light Weapons* (Hays and Jenzen-Jones, 2018). Please refer to this publication for more information.

Image 6.1 A crude improvised 'zip gun' with a barrel fashioned from a length of car antenna

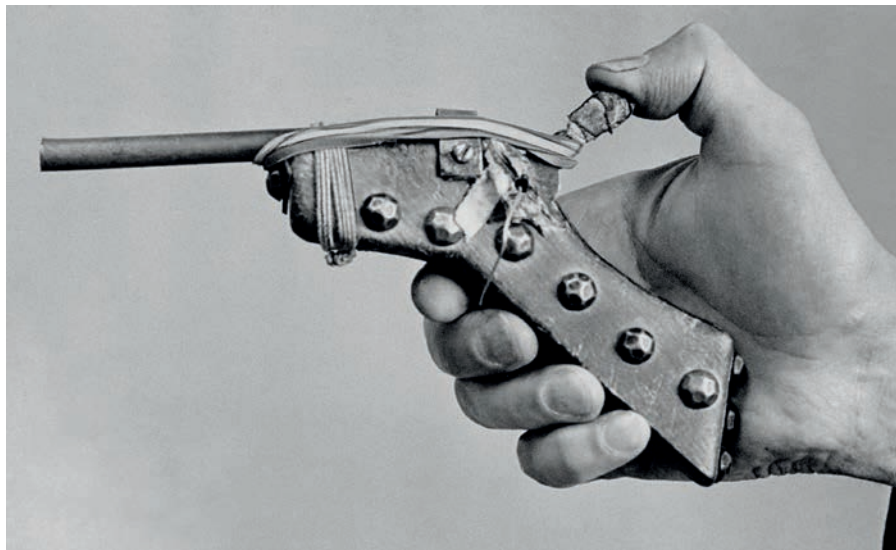

Source: Paul Bernius/*New York Daily News* archive via Getty Images

with authorities. Others are marked with false serial numbers; this and the unusual forensic profile of many improvised and craft-produced weapons complicate criminal investigations.

The barrels of many improvised weapons lack rifling, or have internal diameters that are too large to reliably leave firing marks on discharged projectiles. This makes it difficult or impossible to establish that bullets or pieces of shot recovered at a crime scene were fired from a specific weapon. Indeed, given the challenges in producing rifled barrels with limited tooling or expertise, many such firearms are constructed using readily available household products instead of purpose-built firearms barrels. Gas piping, motor vehicle aerials (antennae), and bicycle frame tubing are all regularly used as barrels for improvised firearms (see Image 6.1). Well-connected groups may be able to obtain barrel blanks with pre-cut rifling (see Box 6.4), but for many criminal purposes, rifling is unnecessary.¹³⁸ Shotguns are generally smooth-bore weapons by design, and even pistol

¹³⁸ Barrel blanks are unfinished barrels which are already rifled, allowing a craft producer to avoid a difficult part of the manufacturing process.

barrels, which are routinely rifled by commercial manufacturers, do not actually require rifling for effective use at very short ranges. Producers of improvised weapons may not consider the additional accuracy afforded by rifling worth the time, effort, and additional cost.

The use of so-called ‘ghost guns’ is now perceived by some as an effective method of evading law enforcement, even that of developed nations (CBS Sacramento, 2016). Detecting manufacturing or conversion activity is also difficult. Since essentially anyone can produce components or even complete improvised or converted firearms in their home, using innocuous materials and common machinery that lack a ‘paper trail’, they often remain undetected until long after their products reach their prospective users. While conventional tracing requests are almost never successful for these types of weapons, there are alternative means of identifying and tracking such weapons. Identifying distinctive characteristics shared by craft-produced weapons can help to identify particular illicit gunsmiths or manufacturing operations, for example (Hays and Jenzen-Jones, 2018).

It should be noted that not all users of improvised weapons are criminals. For example, in the United States, unlicensed ‘backyard gunsmith’ hobbyists operate within the law (provided they do not transfer their products); engaging in the same activity in the United Kingdom, however, would be a criminal offence.¹³⁹ There is little direct crossover between licit and illicit users other than the potential sharing of designs via the Internet or print publications. However, the most viable methods for designing and building improvised firearms tend to prevail in both spheres, giving rise to a degree of commonality across user groups (Hays and Jenzen-Jones, 2018).

Types of improvised and craft-produced small arms and light weapons

Broadly speaking, these weapons can be broken down into three subcategories. In ascending order of sophistication, these subcategories of small arms and light weapons are: improvised and homemade; craft-produced; and semi-professionally produced (Hays and Jenzen-Jones, 2018).

¹³⁹ This is, of course, a matter of context and politics. Improvised and craft-produced firearms were extensively produced and used by resistance groups in Nazi-occupied Europe in the Second World War, but also by terrorist groups operating in Northern Ireland in the late 20th century. See, for example Hays and Jenzen-Jones (2018).

Improvised and homemade small arms and light weapons

This subcategory is defined primarily by the scale of production and the limited expertise and resources available to the maker. These are the simplest weapons that expel a projectile that an investigator is likely to encounter, and will be visibly crude and mechanically simple (see Image 6.2 for a particularly crude example). Improvised weapons are typically conceived and fabricated at home or under field conditions, and without access to modern machine tools. As a result, they are much less capable than their factory-built counterparts. Generally speaking, improvised and homemade small arms and light weapons are limited to single-shot firearms, and simple mortars, grenade launchers, and recoilless weapons (Hays and Jenzen-Jones, 2018).

A firearm can be reduced to two critical components: a barrel and a firing mechanism. At its most basic level, a barrel is simply a tube that is able to accept a projectile or cartridge of a particular size and is capable of withstanding the pressure of the expanding gases that are generated when the weapon is fired.¹⁴⁰ Some improvised firearms are very crude. For example, a ‘slam-fire gun’ consists of two metal pipes (a ‘barrel’ piece and a ‘breach’ piece), one of which slides within the other, and a fixed firing pin at the rear of the breach piece (see Image 6.3).¹⁴¹ When the user pulls the barrel piece sharply back against the breach, the cartridge inside is fired. In this case, the crude weapon is simply the host for the more advanced technology embodied in the ammunition. Ammunition needs to be of a sufficient quality to repeatedly, reliably, and safely discharge shots. Many of these simple weapons fire shotgun cartridges because they are cheap and widely available. They are also relatively safe, as they generate relatively low gas pressures (Hays and Jenzen-Jones, 2018).

¹⁴⁰ The first hand-held firearms were forged or cast metal tubes with a sealed rear end (‘breach’) and a drilled vent (‘touch-hole’) to permit ignition of the black powder charge inside. The propellant was muzzle-loaded along with a spherical lead ball, and a hand-held piece of slow-match was used to ignite the charge. Some improvised firearms continue to follow this antiquated pattern (ARES, 2017; Hays and Jenzen-Jones, 2018).

¹⁴¹ The fixed firing pin is equivalent to the firing pin or striker found in a conventional firearm. This is normally ‘cocked’ to the rear against a spring and released by pulling the trigger to fire the cartridge. In the mechanically simple slam gun, the whole rear portion of the weapon is manually slid back and then quickly forward to achieve the same effect.

Image 6.2 An especially crude improvised muzzle-loading handgun, featuring a barrel crafted from a heavy machine gun cartridge case



Note: The weapon is fired by touching a match to a hole toward the top rear of the case. This weapon was seized by British forces during the Cyprus Emergency in the 1950s.

Source: Jonathan Ferguson/ARES

Image 6.3 Slam-fire shotguns seized from a makeshift workshop used by a gang in Buenos Aires, Argentina



Source: Minutouno.com/Buenos Aires Police



Image 6.4 A crude hand-made percussion lock mechanism fitted to a muzzleloading 'Dane gun' produced in Plateau State, Nigeria

Source: Small Arms Survey

Other improvised weapons are somewhat more sophisticated and effective. Producers in Nigeria and Ghana combine smooth-bore barrels with various breech mechanisms to make break-open cartridge shotguns. Such weapons are often referred to as 'Dane guns', although this term is applied to a range of similar weapons. The barrels on some of these weapons are made from repurposed metal tubing, such as motorcycle suspension forks. A skilled craftsman is often able to make multiple weapons a day from readily available, locally-sourced material. Many 'Dane guns' straddle the 'improvised' and 'craft-produced' categories. Some are simple, comparatively ineffective muzzle-loading percussion weapons (see Image 6.4) while other weapons identified as 'Dane guns' are higher-quality firearms that more closely resemble factory-produced shotguns (CAST et al., 2003; Hays and Jenzen-Jones, 2018).

Identifying the origins of improvised firearms is often difficult. As illustrated by numerous images in this chapter, some superficially resemble their conventionally-produced counterparts, while others look nothing like firearms. A cursory inspection of their components, which often include pieces of pipe, lumps of metal, and a variety of found objects such as tools or toys, is often sufficient to reveal their improvised origin, but tracing them to a particular producer can be challenging. Most lack markings of any kind, and spotting distinctive production patterns often requires technical expertise and familiarity with the materials and production practices used by local improvised firearms makers. It is best to engage the services of a specialist when in doubt (ARES, n.d.; Hays and Jenzen-Jones, 2018).

Craft-produced small arms and light weapons

Some individuals and small groups produce weapons that are more advanced than the improvised weapons described above. These craft-produced weapons require a higher level of skill and access to specialized tools and equipment. They are closer approximations of their commercial counterparts than improvised weapons, but are still visibly crude. They are likely to be roughly made, with sharp edges and crude means of construction including large nuts, bolts, rivets, welds, etc. (see, for example, Image 6.5). These features are occasionally found on facto-

Image 6.5 A conventionally-produced M3 sub-machine gun (top) and a Luty style sub-machine gun (bottom)



Note: The Luty style sub-machine gun was produced without the use of any original-purpose firearm components. Note the comparative similarity of many of the features of these two sub-machine guns.

Source: N.R. Jenzen-Jones/ARES

ry-made firearms, notably wartime expedient designs such as the British Sten, or on ‘last-ditch’ military weapons produced by factions with limited or dwindling access to critical resources (for example, Nazi Germany and Imperial Japan). However, such weapons are relatively rare and well known, and thus are readily distinguishable from ‘true’ craft-produced weapons (Hays and Jenzen-Jones, 2018). Many craft-produced weapons are cruder even than the most basic military firearm mass-produced in a properly-equipped factory. Even with access to basic machine tools, edges of craft-produced weapons are likely to remain indistinct, with uneven angles and undulating surfaces where they ought to be flat. Markings, when they are actually applied, are often roughly stamped to unequal depths using individual letter stamps (see, for example, Image 6.10).

In recent years, craft producers have gained access to relatively high-quality materials and equipment that were formerly the preserve of the commercial firearms industry or other specialized sectors. These items include high-strength steel tubing, bar, and sheet metal stock; computer numerical control (CNC) machining tools; and additive manufacturing (3D printing) technologies (see Box 6.1) (Hays and Jenzen-Jones, 2018; Jenzen-Jones, 2015d). As a result, individuals and groups with basic online research skills and access to basic tools are able to manufacture viable homemade small arms. These weapons range from single-shot firearms to shotguns, sub-machine guns, and rifles. Some light weapons, such as mortars, are also relatively easy to craft produce since they are based on relatively simple operational principles (Hays and Jenzen-Jones, 2018).

Box 6.1 3D printing and improvised firearms

Although still a relatively new technology, 3D printing—also known as additive manufacturing—has opened up new possibilities for craft-produced firearms. It is now possible to produce a viable, multi-shot firearm using polymer (plastic) 3D printing alone, though most homemade 3D-printed firearms are still bulky and inferior to their conventionally-made counterparts (Hodgkins, 2015). More promising firearms designs combine 3D-printed components and assemblies with traditionally-made metal components. This approach minimizes the number of complex components that need to be machined while retaining strength and durability where these attributes are needed most.¹⁴² In the future it may be possible to completely bypass traditional manufacturing, producing viable firearms entirely from metal components made on 3D printers. While additive manufacturing technology for ‘printing’ metals exists, prices are currently prohibitively expensive and the firearms produced via this method to date offer no substantial practical advantage over conventional firearms (see Image 6.6) (Jenzen-Jones, 2015d).

142 That is, in pressure and/or load-bearing parts such as the barrel, bolt, and upper receiver.

- **Image 6.6** A copy of the 1911A1 self-loading pistol produced using the direct metal laser sintering (DMLS) method of 3D printing



Note: While a perfectly functional handgun, it costs substantially more than a conventionally-produced equivalent.
Source: Solid Concepts

There are several ways to distinguish 3D-printed firearms and components. Weapons and other objects produced from polymers using additive manufacture are light in weight by comparison with the very robust glass-reinforced plastics used in commercial firearms production. Firearms which are 3D-printed come in a wide array of colours, but pure white and black are the most common. Depending on the printing process used, some 3D-printed firearms have tell-tale lines where the layers of polymer are laid down by the printer, although the lines will be hard to detect in properly finished weapons.¹⁴³

Low-level craft production is widely employed by non-state actors and criminals. Sub-machine guns are an example of craft-produced firearms that are frequently encountered in many parts of the world. These guns are frequently seized by police and military forces throughout Latin America and Africa, and in Australia, Israel, and elsewhere (Hays and Jenzen-Jones, 2018). Some craft-produced sub-machine guns are semi-professionally produced

¹⁴³ Examples include 3D-printed firearms in which the exterior surface has been heat-treated in order to strengthen the otherwise weak and brittle plastic.

Image 6.7 A still from an Islamic State propaganda video showing a craft-produced light cannon chambered for 23 × 152B mm being used against Shia militia targets¹⁴⁴



Image 6.8 A Soviet S-5 rocket (top) and an improvised shoulder-fired rocket launcher (bottom)



Note: A PGO-7V type optical sight from an RPG-7-pattern shoulder-fired recoilless weapon has been added.

Source: US Army, National Ground Intelligence Center (NGIC)

.....
144 Source withheld.

(see Box 6.2) and are standardized to some degree, while others are made by individuals or small groups in residential properties and are consequently of lower quality. In Brazil, the proliferation of these weapons has been substantial. In a 2011 study of weapons seized in São Paulo, 48 per cent of recovered sub-machine guns were homemade rather than commercially manufactured (Hays and Jenzen-Jones, 2018; Instituto Sou da Paz, 2014, p. 27).

Box 6.2 'Artisan' production

The term 'artisan production' may be thought of as a useful modifier in describing particularly high-quality firearms which are produced outside of regular industrial manufacturing. The lack of skill and quality control evident in craft-produced weapons found in the field distinguishes them from high-quality weapons made by professional artisans and firms specializing in producing made-to-order firearms in small quantities for commercial sale (which would otherwise be considered 'craft produced').¹⁴⁵

The distinction is not always clear-cut, however. In less economically developed countries, 'artisan' gunsmiths produce arms of many kinds, some high quality, but others indistinguishable from the 'craft-produced' weapons described in this chapter. The reason for the overlap is that firearm production is still—despite advances in mass production and materials—essentially based on 19th century engineering techniques. These weapons can be replicated or approximated by anyone with access to a small machine shop, or even in some cases by hand.

The relative ease of production means that artisan craftsmen in developing and newly-industrialized nations often make firearms which resemble craft-produced arms, for profit and/or as part of local historical and cultural heritage (Hays and Jenzen-Jones, 2018). Manufacture of such arms typically takes place in areas without local or national regulations governing the production and sale of firearms, or where regulations are difficult to enforce.

Individual gunsmiths may be skilled local blacksmiths and engineers, or may be brought up manufacturing firearms as a family trade. They typically work from a dedicated manufacturing workshop which may be equipped with common workshop equipment capable of producing simple craft-produced firearms chambered for modern cartridges. In the case of traditional black powder weapons, primitive forge facilities may instead be found (ARES, 2017; Hays and Jenzen-Jones, 2018).

Individual craftsmen of the Khyber Pakhtunkhwa region in Pakistan, famous today for their copies of modern designs, have been copying and hybridizing firearms of all types for nearly 200 years, and still sell copies of obsolete weapons (Ahmad, 2012; Jenzen-Jones and McCollum, 2015).

These workers produce a wide variety of firearms, from crude weapons akin to those described above, to well-finished handmade examples, to close copies of commercial self-loading arms (see Image 6.9).

¹⁴⁵ These commercially-made craft-produced weapons are also distinguished by being subject to legal registration and tax requirements, strict marking practices, and proof testing (or at least some form of corporate accountability for quality and safety assurance) (Hays and Jenzen-Jones, 2018). As such, these weapons are not considered in this chapter.

At the more prolific and skilled end of the spectrum, workers in regions such as the Khyber Pakhtunkhwa and Danao, in the Philippines, represent part of a larger scale semi-professional activity (Hays and Jenzen-Jones, 2018). Many artisan makers produce weapons for illicit purposes as well as for licit (or at least legally tolerated) ones.

It thus becomes clear that the difference between 'artisan-made' and other craft-produced weapons is, in many respects, contextual. While the term is not particularly useful for classifying weapons, it remains a useful descriptor.

Image 6.9 A Pakistani craft-produced bolt-action rifle chambered for the 7 × 57 mm cartridge, which superficially resembles an AK-type rifle



Source: N.R. Jenzen-Jones/ARES

Semi-professional production

Semi-professional manufacturing operations are defined by their ambition as much as by any technical sophistication. Semi-professionally produced weapons are sometimes considered a subset of craft-produced examples, representing the higher end of the complexity spectrum, and blurring the lines between craft-produced and industrially-produced weapons. Some of the end products may be similar or even identical to craft-made equivalents, but the production process is more complex, the pace of production faster, and the scale larger. The range of semi-professionally produced weapons is also often broader and the quality superior to that of other improvised and craft-produced weapons.

Semi-professional production operations typically employ multiple skilled workers capable of producing relatively modern firearms, including high-quality copies of commercial weapons. Some larger operations make use of standard industry techniques and equipment, while smaller workshops do most work by hand using relatively primitive equipment. Both types of operation produce a large number of firearms which are usually supplied in bulk to one or more

distributors, often for profit. One exception, noted in a number of conflict zones, is non-state actors who manufacture light weapons: these are typically intended for use in combat, and profit is rarely a primary motive.

While there is no sharp distinction between traditional commercial manufacturing and semi-professional production, the latter is usually not licensed by local and national authorities and is thus generally considered illicit. Weapons made by semi-professional producers are not often registered with national authorities and sales of these items are not usually reflected in government records (Hays and Jenzen-Jones, 2018). Such weapons end up on both illicit and legitimate local markets.

Commercial finishing techniques such as bluing or Parkerizing, hardening of components, and the presence of (often falsified or counterfeit) markings are typical of weapons in this category. Barrels may also be rifled, or, as with artisan-level production, may be cut from commercial barrel stock. Many of these

Image 6.10 Markings on an AK-type self-loading rifle craft produced in Pakistan



Note: The general fit and finish is quite good, and a superficial inspection would suggest that most toolmarks are fairly typical. A closer inspection, however, reveals questionable markings, including poor alignment and spacing of characters (a common sign of hand-stamped markings), unusual phrasing (PAKMADE), and a calibre marking ('CAL222') not normally associated with AK-type rifles.

Source: N.R. Jenzen-Jones/ARES

Image 6.11 An AK-type self-loading rifle craft produced in Pakistan, without the typical fire selector markings



Source: N.R. Jenzen-Jones/ARES

weapons are effectively high-quality copies of their commercial counterparts, produced without a licence, registration, or other requirements. As a result, it may be difficult or impossible for inexperienced researchers to identify these weapons as craft-produced. It is best to contact specialists if the weapons bear any signs of craft production. Such evidence includes rough finish, unusual markings, crude furniture, lack of rifling, an irregular shape, and proportions that differ from factory-built weapons of the same type. Other signs of craft production include short barrels, strangely shaped handguards, and non-standard selector markings.

The provenance of most semi-professionally produced firearms is also much more difficult to establish. As noted above, their production and sale are not typically recorded in a way that is accessible to authorities, and they are not likely to be licensed. Conventional markings are likely to be absent, false, or misleading, and the significance (if any) of other locally-applied markings may be difficult or impossible to establish (see Box 6.3).

Box 6.3 Counterfeit weapons

Many semi-professionally-produced craft weapons are counterfeits of commercial arms, intended either to pass as real and dupe the unwary, or simply to provide a more readily available or affordable alternative to factory-built firearms. In either case, these weapons are frequently marked with false or misleading manufacturer and model markings (Hays and Jenzen-Jones, 2018).

Semi-professional production, including the production of counterfeit weapons, is commonplace in and near the Pakistani town of Darra Adam Khel. Weapons produced in the region include copies of modern self-loading service rifles, many of which are said to be useful in combat. Darra-made weapons have been used by Taliban insurgents as well as by private militias and government personnel in both Pakistan and Afghanistan (Ahmad, 2012; ARES, n.d.).

Aside from Darra, the Philippine city of Danao is perhaps the best-known hub for counterfeit firearms. These weapons are sufficiently well made to deceive local law enforcement, and to attract buyers on the international market (Pavlovich, 2016, p. 8; see Image 6.12). The illicit industry in Croatia is similarly prolific, though its products are far from direct copies (ARES, 2015b; ARES, n.d.). Croatian weapons such as the Zagi M91, and the spuriously-marked ‘TEC9’ derived from it, are nonetheless made to an extremely high standard, equivalent to that of many commercial factories (Hays and Jenzen-Jones, 2018). Many of the gunmakers in these regions might also be regarded as artisan makers (see Box 6.2). The scale of their operations also likely varies, from hand manufacture to organized low-level mass production.¹⁴⁶

Image 6.12 Exposed slide portion of a craft-produced copy of the Colt 1911 produced in Danao, the Philippines (right), displaying characteristic toolmarks compared with a genuine factory-made example (left)

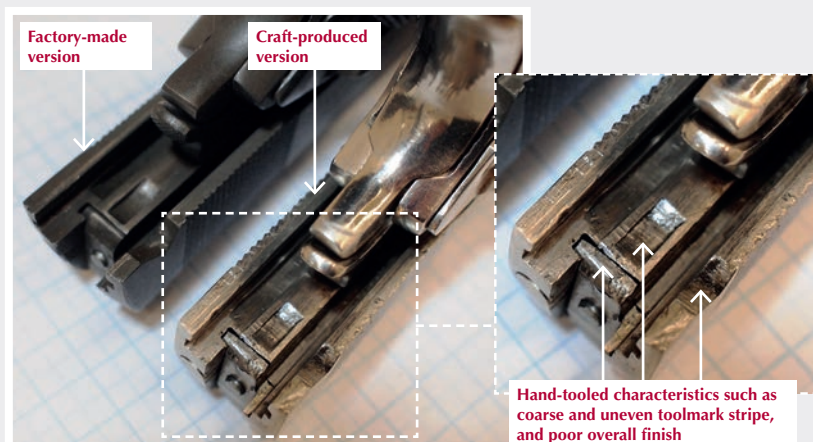

Source: Steven Pavlovich

¹⁴⁶ Interviews with confidential law enforcement and intelligence sources.

Image 6.13 An example of the illicit Croatian design typically marked 'Intratec TEC9', seized in the United Kingdom



Source: Jonathan Ferguson/ARES

Identifying improvised and craft-produced firearms

Designers and producers of improvised and craft-produced small arms and light weapons (such as producers of converted weapons, see below) make use of a wide variety of original-purpose (factory-produced) firearm components (both lethal and less-lethal in nature). They also convert non-firearm components such as lengths of pipe and other plumbing supplies into parts for firearms. Many parts and even complete weapons are fabricated from supplies that are readily available at hardware stores or other commercial and domestic suppliers (Ferguson and William, 2014; Hays and Jenzen-Jones, 2018).¹⁴⁷ As with 'real' firearms, the most important components are the pressure-bearing parts, primarily the barrel and bolt. It is imperative that these items be sufficiently robust to prevent the weapon

¹⁴⁷ As seen in the designs of Philip A. Luty, which have proliferated across the globe for nearly 30 years (Ferguson, 2017b). Luty described his designs as 'expedient', but this should not be taken to imply ease of manufacture or status as an 'improvised' weapon. They are sufficiently sophisticated to require considerable skill to produce, and are definitively 'craft-produced' weapons.

from failing catastrophically and potentially injuring the user (Ferguson and Jenzen-Jones, 2014a; Ferguson, 2017b). This may be an issue with host weapons made from alloys and plastics not intended for use in firearms. Zinc alloy and ABS plastics are commonly used in blank-firing weapons due to their lower cost. When live ammunition is used, breech pressures increase dramatically, and the component parts may fail—often critically—after only a few shots (King, 2015, p. 3).

For use with sufficiently low-pressure ammunition, barrels and bolts are also adapted from commercially available tubing, typically steel or even copper alloy. Loyalists in Northern Ireland made improvised sub-machine guns out of square-shaped steel tubing commonly used in the furniture industry.¹⁴⁸ The use of unmarked furniture tubing made it difficult for authorities to identify and dismantle the facilities at which these and other weapons were manufactured. Less commonly, makers and especially converters obtain pre-rifled barrel blanks from the commercial trade. Barrel blanks require a certain level of skill to install, even in a simple blowback-operated pistol, as a chamber must be precisely machined and hand-finished (Ferguson and Jenzen-Jones, 2014a; Hays and Jenzen-Jones, 2018).

Rarely, designers may also devise accessories that are similar to commercially-manufactured items. As previously noted, accessories are items that are attached to small arms or light weapons and increase the weapon's effectiveness or usefulness, but they are not essential for the basic, intended use of the weapon (Grzybowski, Marsh, and Schroeder, 2012, p. 245). The most common improvised accessories are simple sound suppressors (see Image 6.14), which often comprise only a single expansion chamber, unlike more complex commercial designs. Like the improvised weapons to which they are attached, these items are relatively ineffective and arguably mainly for 'show' (Ferguson and Jenzen-Jones, 2014a). Prominent examples of improvised sound suppressors are those supplied with so-called 'assassination kits' that European authorities have seized with converted Baikal pistols. The kits consist of a pistol with a threaded barrel, a sealed sound suppressor, and ammunition, often all contained in a plastic carrying case (Linning, 2016).

¹⁴⁸ They also created hybrid firearms from genuine Sterling sub-machine gun parts that were stolen from British authorities (Shea, 2007).

Image 6.14 A 6P42 series traumatic pistol, itself a design originally based on the lethal-purpose Makarov PM, illegally converted to fire 9 × 18 mm lethal-purpose ammunition and fitted with a sound suppressor



Source: Maxim Popenker

Converted and ‘reactivated’ weapons

Overview of converted weapons

In most cases, converted weapons are lethal-purpose weapons which have been made by modifying a replica firearm, a non-lethal firearm, or a less-lethal firearm (King, 2015, pp. 8–9). Converted weapons include those based on: blank-firing firearms; less-lethal weapons including ‘traumatic’ weapons and less-lethal launchers;¹⁴⁹ and flare guns, which have been modified to fire lethal-purpose (‘live’) ammunition. The term also includes some types of modification to deactivated weapons (see below) (Ferguson and Jenzen-Jones, 2014a). There is significant overlap between improvisation, craft-production, and conversion.

Blank-firing firearms include alarm guns and starter pistols, which are typically noise- and flash-producing replicas of real firearms. So-called ‘traumatic’ handguns are a type of less-lethal weapon that are designed for self-defence purposes and fire ammunition containing rubber balls or irritants, such as ‘pepper

¹⁴⁹ For example, 37 and 38 mm less-lethal launchers have been converted by several non-state actors to fire lethal-purpose 40 × 46 mm ammunition, such as high-explosive rounds (ARES, n.d.; ATF, 2010).

spray' (oleoresin capsicum) (Ferguson and William, 2014).¹⁵⁰ Traumatic handguns are, broadly speaking, the most suitable for conversion since they have barrels that permit the passage of a projectile (unlike many alarm guns and starter pistols). Gas alarm guns without barrel occlusions are also highly prized for conversion. For this reason, the Baikal IZH-79-8 and IZH-79-T handguns which have historically been readily available in the UK – where their sale or possession is in fact illegal – are commonly recovered there (Ferguson and William, 2014; King, 2015, p. 9).¹⁵¹

Traumatic pistols are functionally identical to the broader category of 'front-venting' blank-firing handguns, in which propellant gases are vented forward, out of the barrel of the device. Front-venting blank-firing types may prove more difficult to convert, as they are only required to vent propellant gases and often feature deliberate barrel occlusions to prevent the passage of solid projectiles. Generally speaking, top- or side-venting types, which typically feature a substantial metal occlusion permanently integrated into the barrel and extending back into the chamber area, are substantially more difficult to convert. There are other methods used to impede the conversion process (Florquin and King, 2018). These reflect a concerted effort to prevent illicit conversion (Ferguson and William, 2014; Hays and Jenzen-Jones, 2018).

It should be noted that given sufficient will and expertise, essentially any non-lethal or replica firearm can be converted to fire live ammunition. Whether criminals will go to the trouble of converting an item depends on the level of skill required to achieve the conversion, and the cost and risk of converting weapons versus acquiring conventional firearms. In the UK, for example, most converted blank-firing handguns used in crimes are traumatic and front-venting types (typically illegal there); the corresponding rarity of legal top-venting types shows these models are seriously challenging for criminals to convert (Hays and Jenzen-Jones, 2018).

It is also important to note that a very basic conversion can be effected simply by cutting the existing barrel off at the chamber, and relying upon the chamber itself to generate sufficient pressure to project the bullet (Ferguson and William, 2014). While traumatic guns altered in this way are wildly inaccurate and less

¹⁵⁰ Most are also capable of firing blank cartridges.

¹⁵¹ The Baikal IZH-79-8 and IZH-79-T are also known as the 6P42 series.

powerful than a conventional pistol firing a commercial bullet, they can cause severe injuries at short range.¹⁵²

Many of the technical requirements and manufacturing techniques used in the production of improvised and craft-produced small arms and light weapons also apply to the conversion of non-lethal and less-lethal weapons. However, converting blank-firing and traumatic pistols is often more attractive to criminals because the converted weapon, made largely of conventionally-manufactured components, may be of higher quality than available improvised and craft-produced weapons which have been built from scratch (Ferguson and William, 2014; Ferguson and Jenzen-Jones, 2014a). Blank-firing and traumatic pistols are also significantly less expensive than lethal-purpose weapons, in some cases costing ten per cent of the cost of a 'real' pistol (King, 2015, p. 8). Indeed, converted blank-firing and traumatic pistols are, worldwide, the most commonly recovered subcategory of converted or reactivated firearms (ARES, n.d.).

Globally, blank-firing weapons made in Turkey represent a substantial number of recovered converted firearms. Researchers have documented sales of converted Turkish-made blank-firing handguns, sub-machine guns, and rifles on illicit physical and online markets in six countries, and they have been used by criminal elements in dozens more, primarily in Europe and North Africa (ARES, n.d.; Jenzen-Jones and McCollum, 2017; Florquin and King, 2018). Blank-firing weapons produced in Croatia, Russia, Germany, and elsewhere are also still circulating globally, but in substantially lower numbers (ARES, n.d.).

In summary, the choice of conversion over improvisation or craft production is likely to be based upon the time and effort required to convert a given weapon, and the availability (licit or illicit) of the 'weapon' to be converted versus a conventional firearm. It is also contingent upon national laws, which may restrict the type of weapons available for conversion (Hays and Jenzen-Jones, 2018). There is also considerable psychological and prestige value attached to functioning weapons that closely resemble original purpose firearms. Not only do such weapons more easily pass as 'real' firearms to other criminals and potential victims, but they may better fit users' image of a firearm.¹⁵³

152 A bullet fired from a traumatic gun without a barrel can penetrate several inches of ten per cent ballistic gelatine at contact distance (Channel 4, 2016).

153 Author interviews with senior UK intelligence and law enforcement personnel, April 2016.

Identifying converted weapons

Generally speaking, blank-firing weapons, whether converted or not, are identified by the same types of physical characteristics and markings as conventional firearms. Most less-lethal and non-lethal weapons have markings that identify the make and model of the weapon, and often include a serial number as well. Other markings, such as a calibre designation, may also be present. It should be noted that some blank-firing weapons have ‘faux’ serial, batch, or lot numbers—that is, numbers that appear to be unique identifying marks, but that are actually identical across a batch, lot, or model of weapon (ARES, n.d.). It may be difficult for a non-specialist to determine whether a given example has been converted; possible indicators include visible toolmarks, ill-fitting or distinct barrels or barrel assemblies, welding or brazing, and the presence of lethal-purpose ammunition.¹⁵⁴

Overview of reactivated weapons

Reactivated weapons are deactivated weapons that have been wholly or partly returned to an operational state. Deactivated weapons are original-purpose (typically lethal) firearms that have been rendered ‘permanently’ inoperable, that is, incapable of discharging a projectile.¹⁵⁵ These weapons are often sold to collectors (EU, 2017; Jenzen-Jones, 2015f).¹⁵⁶ Deactivated weapons are frequently drawn from surplus stocks and are often old, incomplete, worn-out, or otherwise unsafe to fire, making it especially important to prevent a live round being easily chambered. The process of adapting properly deactivated weapons to lethal-purpose use is often called reactivation or conversion. The term ‘conversion’ is sometimes used to indicate that a weapon may not be ‘reactivated’ to its full, original capabilities, but may still pose a lethal threat (for example, when a deactivated rifled barrel is replaced with a functional, smooth-bore barrel. The weapon is no longer a ‘rifle’ and is therefore less accurate at longer ranges, but it is still potentially lethal) (Jenzen-Jones, 2015f).

154 Brazing is a form of high-temperature soldering.

155 Such weapons may be described with terms such as ‘inert’, ‘drill-purpose’, ‘innocuous’, among others.

156 It is important to note that various armed forces retain weapons that have been rendered non-functional but that may not qualify in legal sense as ‘deactivated’. Typically, the intent here is to prevent soldiers from attempting to fire—or accidentally firing—live rounds in a training environment where live ammunition is not used for safety reasons.

There are also other types of weapons which are sometimes thought to fall into this category, including lethal-purpose weapons converted to fire only blank ammunition (so-called ‘acoustic expansion weapons’) and those converted to fire very small, low-power cartridges (often known as ‘Flobert’ calibres).¹⁵⁷

Deactivation standards vary significantly, both by country and by type of deactivated firearm. Some national standards are much more rigorous than others. Prior to 2015, deactivation standards in Slovakia were lower than in other European countries (Jenzen-Jones, 2015f; Samuel, 2015).¹⁵⁸ The Slovakian government raised its standards after terrorists used deactivated Czech Sa vz. 58 self-loading rifles acquired in Slovakia in the 2015 Paris attacks, which also prompted changes in deactivation standards in other European countries (European Commission, 2016).¹⁵⁹

Identifying reactivated weapons

Non-specialists may readily confuse deactivated and ‘reactivated’ firearms with their original lethal-purpose equivalents (see Image 6.15). Signs that a weapon may have been deactivated include:

- the absence or modification of critical components, such as the bolt or barrel;
- working parts that are immobile;
- proof marks or other marking indicating that the item is a legally-compliant deactivated weapon; and
- welding or brazing.

Deactivated weapons that have been reactivated may be identifiable in a similar manner to converted blank-firing weapons. Signs of reactivation include visible toolmarks, welding or brazing, and the presence of lethal-purpose ammunition. In most cases, inspection by specialists is advisable.

Image 6.15 shows three PM model self-loading handguns. No. 1 is a fully functional factory-produced pistol. No. 2 was deactivated before being converted to fire lethal-purpose cartridges. No. 3 is a craft-produced copy, made by skilled gunsmiths in Pakistan. At first glance, the weapons appear identical.

157 For more details, see Florquin and King (2018).

158 See, for example, HMSO (2010).

159 For further details, see Florquin and King (2018).

Image 6.15 Three versions of a PM-type self-loading handgun

Source: N.R. Jenzen-Jones/ARES

A closer examination of the physical features of the first and second handguns reveals key differences, especially when the two are disassembled. The most noteworthy difference is the barrel, which had been replaced with an unfinished copy. The third weapon can be differentiated from the other two by both its physical features and its markings, including irregularities in serrations on the hammer and safety/selector, differences in marking style and quality, looser tolerances, and inconsistent finish.

Box 6.4 Capability

All of these weapons are, by their very nature, less capable than their factory-made counterparts. Both craft-produced and improvised firearms are often unreliable, inaccurate, and unsafe. Accurate rifled firearms are rarely within the production capabilities of those producing improvised or craft-produced small arms and light weapons, and so the majority of these weapons feature smooth-bore barrels (though they are often incorrectly dubbed 'rifles') (Hays and Jenzen-Jones, 2018).

Improvised weapons and converted blank-firing weapons are often of particularly poor quality. In many cases, the metals used in these weapons are insufficiently strong for their intended purpose. Their weak construction obliges makers to employ low-pressure cartridges.¹⁶⁰ Use of these cartridges drastically affects the range, accuracy, and terminal effect of these weapons, though of course at close range these characteristics are less important. Even when carefully manufactured, the structural integrity of many improvised weapons remains a serious issue. Some remain intact for only a few rounds (Hays and Jenzen-Jones, 2018).

Image 6.16 A typical pen-type zip gun



Source: Stills from a YouTube video¹⁶¹

However, some craft-produced weapons approach modern factory standards. Traumatic or blank-firing pistols converted using genuine barrel blanks compare favourably with lethal purpose equivalents, provided they are equipped with sights and thoroughly tested for function and accuracy

¹⁶⁰ Examples of low-pressure cartridges include 12 bore shotgun, .32 ACP, and .22 LR.

¹⁶¹ Video details withheld on security grounds.

(Hays and Jenzen-Jones, 2018; Forgotten Weapons, 2017a). Their barrels are inherently far stronger than improvised barrels, since they are made for use in factory-made guns. Producers of converted firearms that use these materials are also likely to chamber the weapon for commercially available ammunition rather than improvised ammunition. The end result is a relatively potent, long-lasting weapon (Ferguson and William, 2014; Ferguson, 2014a). In other words, improvised, craft-produced, and converted weapons range in capability from practically useless to near parity with commercially available types. They should therefore be assessed on a case-by-case basis.

One significant complication of reliance on handmade components is a total lack of the interchangeability of parts, which makes it difficult for most users to carry out repairs. If a major component fails, the user is obliged to seek a craft-produced replacement, or to replace their weapon with a new one. This also affects the practice of disassembling a weapon before it is smuggled, which is a common technique employed by arms traffickers (Pavlovich, 2016, p. 11). When multiple weapons are disassembled and their parts become mixed in transit, a user may find themselves with a poorly functioning, non-functional, or even unsafe weapon when the parts are reassembled.

Firing improvised ammunition can be particularly dangerous to the user, especially as it may be used with factory-made weapons that are otherwise considered safe. While some hand-loaded cartridges are safe and reliable, others are outright dangerous. Out-of-specification cases and projectiles are likely to cause feeding issues, especially in self-loading firearms. The use of match heads and other unconventional propellants may result in the weapons not firing or other malfunctions.¹⁶² An improperly loaded and/or chambered round may destroy a weapon and injure or even kill the operator. The combination of improvised ammunition and an improvised or craft-produced firearm is particularly dangerous, compounding the problems inherent in both (Ferguson and Jenzen-Jones, 2014a; Hays and Jenzen-Jones, 2018).

Improved and craft-produced ammunition

The greatest activity in the area of ammunition improvisation or craft production is with light weapons. Non-state armed groups, which expend large quantities of ammunition for grenade launchers, mortars, recoilless guns, and rocket launchers in a typical conflict, are particularly likely to turn to craft production (Hays and Jenzen-Jones, 2018; see Image 6.17). Improvised mortar projectiles are fairly common in the Middle East and North Africa, and are manufactured and employed by a variety of groups (ARES, n.d.). Notably, the Islamic State has manufactured ammunition for mortars and other weapons on a quasi-industrial scale. Colombian militant groups (especially the Revolutionary Armed Forces of Colombia (FARC)) are also known for their activities in this area, which were directly influenced and facilitated by members of the Provisional Irish Republican Army (PIRA) (Hays and Jenzen-Jones, 2018).

¹⁶² An example is 'hang fire', which is when there is an unexpected delay between the functioning of the trigger mechanism of a gun and the ignition of the propellant.

Image 6.17 Improvised mortar projectiles converted from gas cylinders, Syria, 2013



Source: Molhem Barakat/Reuters

Given the wide range of improvised and craft-produced light weapons, the forms and natures of improvised light weapons ammunition are vast. Cartridges for cannon are rarely improvised due to their complex production requirements. Larger ammunition, including projectiles for grenade launchers, mortars, and recoilless weapons, are often crudely improvised, as are rockets. The accuracy of improvised ammunition produced for all types of light weapons is generally limited, and securing the required materials can be difficult. Producers of improvised light weapons ammunition often have to be able to produce or repurpose both high-explosives (either from commercial or bulk explosives, or from ‘harvesting’ explosives from military munitions or other sources) and low-explosive propellants (for use in propellant charges, rocket motors, etc.) (Ferguson and Jenzen-Jones, 2014a; Hays and Jenzen-Jones, 2018). More specialized functional types of ammunition are sometimes also improvised, including smoke, incendiary, and chemical weapons (ARES, n.d.).

In the case of small arms, there is a clear criminal preference for factory-made or reloaded ammunition, even where the street value for such ammunition is very

high (sometimes many times higher than commercial pricing).¹⁶³ Improvised firearms are typically designed around readily available cartridge types, due to the substantial difficulties inherent in producing functional cartridge cases, projectiles, and primers from scratch (Hays and Jenzen-Jones, 2018).¹⁶⁴ One alternative to lethal-purpose ammunition is converted non-lethal and less-lethal ammunition. Ammunition used in blank-firing and traumatic firearms, as well as in some nail guns, is sometimes modified with the addition of a projectile.¹⁶⁵ In many countries, blank cartridges are readily available (and often unlicensed), and contain charged and primed cases that require only the addition of a viable projectile for lethal applications. However, most available blank ammunition is made for purpose-built blank-firing weapons and is deliberately manufactured to different specifications than lethal-purpose ammunition. Generally speaking, this ammunition requires specific modifications to be fired from weapons other than converted blank-firing firearms (Ferguson, 2014a). Similarly, some blank ammunition for lethal-purpose firearms, including the blanks used in film and television, will not chamber in a blank-firing weapon without extensive modifications to the weapon.

For these reasons, craft production of ammunition and the modification of existing cartridges is often a last resort. Instead, local users may employ various crude methods to reload fired cartridge cases.¹⁶⁶ Reloading ammunition is relatively straightforward. The reloader simply punches out the expended primer cup from a cartridge case and reloads it with an improvised composition made from match heads, small percussion caps from a child's toy, or another impact-sensitive mixture. These improvised primers are reasonably reliable ignition sources. The reloader then makes a projectile and an improvised propellant charge from materials such as match heads or black powder extracted from fireworks (Hays and Jenzen-Jones, 2018). Projectiles are improvised in different ways, including

163 Author interviews with confidential UK and European law enforcement sources, 2015–17.

164 Common calibres used globally include 12 gauge or .410 bore shotgun cartridges, .22 rimfire rifle cartridges, and centrefire calibres in the .38/9 mm range (Hays and Jenzen-Jones, 2018).

165 Powder-actuated tools make use of controlled chemical combustion in much the same way as a firearm, employing specially-designed blank cartridges to act on either the head of a fastener (such as a nail) or a piston (which, in turn, strikes the head of a fastener), driving the fastener into the target material at very close range (Frank et al., 2012).

166 This is especially the case where certain calibres or types are in short supply, such as suitable big game hunting ammunition (Y-Man, 2013a; 2013b).

Image 6.18 Improvised ammunition made by modifying conventional cartridge cases, signal blanks, and charges used by powder-actuated tool cartridges



Source: EkoCzao

the traditional methods of casting in a two-piece mould, or drop-forming from lead (Carman, 1955, pp. 173–74). Alternatively, they may be formed from metal, primarily steel, brass, or copper alloy, and may exhibit tell-tale toolmarks.¹⁶⁷ Projectiles are also made from, among other items, ball bearings, air rifle pellets, and steel reinforcement bar for concrete ('rebar') (see Image 6.18). The presence of these items may assist in identifying improvised ammunition (Ferguson, 2014a; Hays and Jenzen-Jones, 2018).

In developing nations, fired shotgun cartridges, which are designed to be disposable, are commonly reloaded with lead shot produced locally. The shot is typically made from existing sources, including discarded household items such as battery cells, and is sometimes poured into moulds or drop-formed using trees as substitute shot towers (Hays and Jenzen-Jones, 2018).

Improvised ammunition is often crude. Small-calibre improvised ammunition may feature:

- projectile types which do not match the case;
- cases or projectiles made from industrial or household materiel (for example, nail gun cartridge cases; ball bearings);
- crudely cast or machined projectiles;
- obvious signs of reloading or modification (cuts, solder, adhesives, etc.).

Improvised ammunition for light weapons also often appears crudely finished. Visibly hand-applied welding or brazing; extensive use of non-specialized external fasteners such as common bolts and nuts; low-quality or absent paintwork; repurposed industrial or household items (for example gas cylinders or industrial piping); and other rough and ready measures are signs that ammunition may be improvised.

¹⁶⁷ Some commercial hunting projectiles are also turned from copper alloy and other metals (Pergrine, 2015a; 2015b).

Muzzle-loading firearms

Overview of muzzle-loading firearms

Until the 19th century, the most common firearms were single-shot muzzle-loading weapons. Strictly speaking, ‘muzzle-loading’ simply refers to any gun that is loaded from the muzzle (front) of the barrel, or in the case of revolvers, the cylinder.¹⁶⁸ This category of weapons includes those that are loaded with rounds of ammunition other than self-contained cartridges, such as propellant powder and a bullet wrapped in paper or other combustible material (ARES, 2017). However, it also includes modern arms such as the Russian GP-series grenade launcher, which uses semi-caseless ammunition but is loaded at the muzzle, and ‘in-line’ muzzleloaders (see Image 6.19). Practically speaking, the term ‘muzzle-loading firearm’ is most often used to describe weapons that may be lethal, but are obsolete and rarely encountered in the field, such as muskets.

Muzzle-loading firearms remained common for decades—in economically less-developed countries—until the mid-20th century. Gunflints for flintlock arms (a type of muzzle-loading firearm) were exported from Britain to African nations until the 1960s (Whittaker, 2001). Even today, muzzle-loading firearms are still sometimes encountered in the field (ARES, n.d.). These weapons are typically craft-produced (see above) and used for hunting (including poaching), self-defence, and militia activity in economically less-developed countries (Hays and Jensen-Jones, 2018).

Image 6.19 An American Michigan Arms Wolverine in-line muzzle-loading rifle



Source: Chuck Madurski via ARES

168 Muzzle-loading firearms are often colloquially referred to as ‘muzzle-loaders’ or ‘muzzleloaders’.

Elsewhere, antique muzzle-loading firearms and replicas are rarely used beyond recreational shooting by collectors and by hunters. In-line muzzle-loading guns were pioneered in the United States in the 1980s and targeted at the recreational hunting market (Sigler, n.d.).¹⁶⁹

Identifying muzzle-loading firearms

Muzzle-loading firearms may be either rifled or smooth-bore weapons, using various initiation methods including flintlock and percussion lock designs.¹⁷⁰ Fundamentally, they consist of the archetypal 'lock, stock, and barrel'. The 'stock' and 'barrel' are similar to those found on modern firearms. The 'lock' is the functional equivalent of the receiver in contemporary firearms, acting as a baseplate and housing for the mechanical parts of the weapon (see inset in Figure 6.1). In muzzle-loading designs the flint or percussion cap is separately located on the lock. While most muzzle-loading small arms make use of black powder, some modern commercial muzzle-loaders use smokeless propellant (Fadala, 2004).

Figure 6.1 The parts of a muzzle-loading flintlock rifle

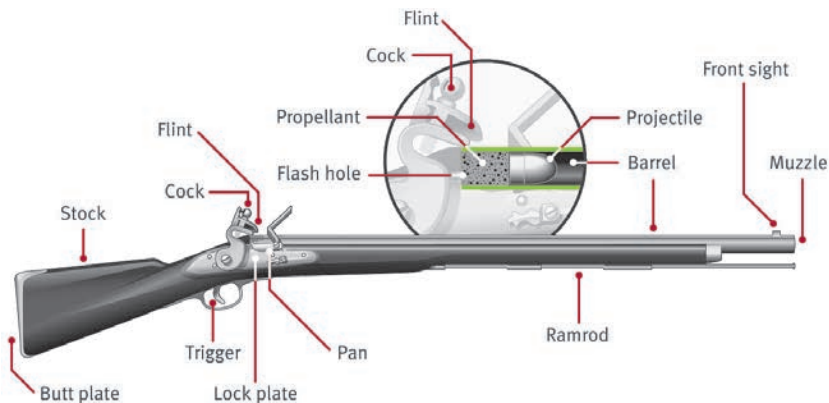

Note: The inset shows parts of a percussion lock.

¹⁶⁹ In-line muzzle-loading guns superficially resemble single-shot centrefire firearms, as they typically break open for priming, but not for loading of the main charge or projectile (these being loaded from the front of the barrel). They also employ a striker mechanism in line with the barrel of the weapon, rather than the traditional external lock (Sigler, n.d.).

¹⁷⁰ For a discussion of early firearms designs see also Butler (1971).

Image 6.20 A producer's workshop with selected hand tools, Nigeria



Source: Gsell and Nowak (2018)

— Authors: N.R. Jenzen-Jones with Jonathan Ferguson

CHAPTER 7

Gathering Arms and Ammunition Data in the Field: Advice for Researchers

Introduction

Gathering data on arms and ammunition in the field is an important element of some types of investigation. Material proof of specific types of arms and ammunition can provide compelling evidence that specific stakeholders have (or have not) been involved in activities of interest, such as illicit arms trading, arms diversion, human rights abuses, or criminal acts. It can also help investigators understand what led to the events under investigation. Frequently, the collection of such evidence also provides insight into the military capabilities of belligerents.

Successful—and even, sometimes, unsuccessful—field investigations are rich sources of data. For journalists, field investigations often generate entirely new stories and support existing ones. Such work can capture the public imagination, bring attention to violations of international law, and highlight cases of arms diversion.¹⁷¹

Gathering data in the field has a number of inherent risks. The weapons themselves may pose a hazard. They may be loaded and ready to fire, in poor physical condition, or even booby-trapped. Additionally, the environment in which weapons of interest are encountered may be littered with explosive remnants of war (ERW), such as unexploded ordnance (UXO), abandoned or poorly stored munitions, landmines, and improvised explosive devices (IEDs). These hazards are often hidden, compounding the risk to field researchers. In some cases, journalists and other researchers may be subject to harassment, detention, or imprisonment by local authorities, who sometimes view the gathering of data on arms and ammunition as a threat to the state or to their own interests.

Thorough planning—particularly, developing a risk management plan—is therefore essential prior to deploying to a conflict-affected area. This planning includes becoming familiar with the groups involved in the fighting, the types of weapons and ammunition that are likely to be encountered, the orientation of the confrontation lines, and the acquisition and proper use of personal protective equipment (such as body armour) and communications devices. Therefore, verifiable consent and permission should be gained from the relevant persons prior to any data-gathering fieldwork.

¹⁷¹ See, for example, Chivers (2012a; 2012b).

Given the challenges of researching and reporting on arms and ammunition in the field, some organizations choose to deploy specialized teams, engage outside organizations or contractors, or train specialist personnel within existing teams.

While the ideal standard of evidence may be the physical retrieval of samples of arms and ammunition, this is often beyond the capabilities of many researchers, and of limited benefit to some organizations, such as news media. Moreover, there are often barriers to physically gathering samples, from simple safety matters, to national and international legislation, to the attitude of local authorities. Consequently, for many arms and munitions investigations (AMIs), it is essential to correctly record evidence in-situ.

Safety considerations

Journalists and researchers should, in general, avoid handling arms and ammunition wherever possible. Nevertheless, those involved in fieldwork should endeavour to learn the mechanical and handling characteristics of weapons likely to be encountered. Key safety considerations are:

- Treat all firearms as if they are loaded, and all ammunition as if they are live, until you have personally confirmed otherwise.
- Do not rely on a weapon's safety mechanism to prevent it from firing.
- Never assume that arms or ammunition are safe to handle until they have been inspected by a subject matter specialist such as an armourer, ammunition technical officer (ATO), or explosive ordnance disposal (EOD) technician. Armourers and other weapons specialists are generally best placed to advise on the safety of small arms and light weapons, as well as unfired ammunition. With live (fired or unfired) ordnance, EOD technicians and ATOs are often the best qualified people to advise.
- Anyone intending to handle arms or ammunition must receive appropriate safety training.

In addition to the safety considerations specific to arms and ammunition outlined below, there may be site-specific considerations. Journalists and researchers should conduct a full and informed appraisal of the local security situation before doing any field research related to arms. Factors to consider include:

- the presence of hostile state or non-state forces, criminals, or local populace;
- structural dangers (such as damaged buildings and engineering flaws);
- hazardous materials (such as chemical and radiological materials and devices, and toxic industrial chemicals and materials); and
- biohazards (such as toxins, decaying corpses and carcasses, and local diseases) (US Army, 2010).



Avoid handling arms unless absolutely necessary.

Small arms and light weapons

When possible:

- ensure that the ammunition source (magazine, clip, belt, or individual rounds) is removed from a weapon before handling it,
- ask the weapon's owner to unload the weapon for you, and confirm it is unloaded; and
- always ensure that the weapon is pointed in a safe direction (away from yourself and others) during all unload and clear procedures (see Box 7.1).

When handling firearms, remember, at a minimum, the four 'golden rules' of firearms safety:¹⁷²

1. Always treat the weapon as if it were loaded.
2. Always keep the muzzle of the weapon pointed in a safe direction.
3. Always keep your finger off the trigger unless you intend to fire the weapon or perform a required function check.
4. Always keep the weapon unloaded unless you intend to fire it. If you need to check the function of the weapon with ammunition, use drill or dummy rounds instead of live ammunition.¹⁷³

¹⁷² There are two key risks to handling a firearm of unknown provenance: (1) Risk of accidental discharge. Solution: Know how to make safe and/or unload weapon safely. (2) Risk of catastrophic event during firing due to poor build quality, damage, storage, condition, etc. Solution: Do not fire a firearm unless absolutely essential.

¹⁷³ The primer and propellant should be visibly absent or inert in drill and dummy rounds. They should consist of factory rounds with a fluted case, or inert rounds with a drilled case (see Chapter 4).

Box 7.1 Unload and clear procedures

The basic unload and clear procedure for unloading firearms and rendering them safe to handle is outlined below. It is important to note that this explanation is provided as a guide only: wherever practicable, unload and clear procedures should only be attempted by properly trained personnel. Unload and clear procedures for light weapons are not included in the text below, as they are often more complicated than comparable procedures for small arms and, in some cases, pose a considerably higher risk.

When possible, you should ask the owner of a weapon to unload it for you, and then confirm the weapon is unloaded before handling it. If it is necessary to unload a weapon yourself, ask the owner's permission before doing so. Always remember to make a visual and tactile inspection of the weapon to confirm it is safe to handle.

If you must unload and clear a weapon, and you do not have the correct, step-by-step instructions from the manufacturer or another credible source, remember these three basic steps:

1. Remove the ammunition source from the weapon. The ammunition source may be a magazine, clip, belt, or individual rounds.
2. Cycle the weapon's action (by using the cocking handle(s), bolt handle, or similar weapon feature) and, where possible, hold the action open.
3. Visually inspect the weapon's chamber, magazine housing, feed ramps, and other areas that feed live ammunition to ensure that they are clear.

If possible, these three steps should be followed with a weapon's safety mechanism(s) engaged.



Wherever possible, avoid handling arms unless properly trained.

Explosive ordnance

Munitions that contain a high-explosive (HE) fill are considered to be 'explosive ordnance'. Explosive ordnance includes many types of ammunition for light weapons (see Chapter 5). When in doubt, treat suspect ammunition as explosive ordnance, and act accordingly. Explosive ordnance is most commonly encountered in the form of projectiles (fired from a weapon system that has a barrel), rockets or missiles (that use a rocket motor for propulsion), or manually-employed ordnance such as hand grenades or landmines. In a conflict-affected environment, you may encounter ERW. ERW refers to both abandoned explosive ordnance and unexploded ordnance (IMAS, 2003). Other types of ordnance may be encountered, including emplaced landmines, booby traps, and IEDs.

- **Abandoned explosive ordnance (AXO)** is explosive ordnance that has not been used during armed conflict, has been left behind, and is no longer under the control of the party that abandoned it. Such ordnance may or may not have been primed, fused, armed, or otherwise prepared for use (UN, 1980; IMAS, 2003).
- **Unexploded ordnance (UXO)** refers to ordnance (rockets, projectiles, hand grenades, and others) that have been used but failed to detonate as intended (IMAS, 2003). Failure rates may be as low as one or two per cent, or as high as 30 to 40 per cent, depending on a range of factors, such as the quality of original manufacture, the age of the weapon, storage conditions, the method of employment, and environmental conditions.
- **Landmines and booby traps** are munitions that have been placed, buried, dropped, thrown, or otherwise deployed with the intention of harming or hindering personnel or vehicles near the device. Many landmines and booby traps are unintentionally triggered (or initiated) by the victim(s) (UN, 1980).
- **Submunitions** are smaller explosive munitions that are scattered from larger carrier/cargo rounds. The majority of cargo rounds are either fired from the ground or dropped from the air. Many submunitions have unreliable fusing systems and can remain hazardous for extended periods of time.
- **Improvised explosive devices (IEDs)** are ordnance items made in an improvised manner that incorporate explosive, noxious, pyrotechnic, or incendiary chemicals and are designed to destroy, incapacitate, harass, or distract. They may incorporate factory-produced ordnance but often include non-military components (NATO, 2018, 4.3).

Untrained and inexperienced persons should never touch or handle explosive ordnance. If the aim is to gather data that requires the handling of ordnance, the researcher should seek appropriate training or be accompanied by a suitably trained person or team.

Should you encounter ERW, remember the ARMS acronym:

AVOID the area.

RECORD all relevant information from a safe distance.

MARK the area to warn others.

SEEK assistance from the relevant authorities.

Ordnance and, in particular unexploded ordnance, is dangerous. Where possible, follow these rules:

- First and foremost, do not touch arms and ammunition unless absolutely necessary. Never handle unexploded ordnance.
- Try to avoid approaching ordnance encountered in the field wherever possible. Use optics to examine a suspected unexploded item from a distance. Camera zoom lenses, binoculars, and spotting scopes are all excellent tools for examining these items from a safe distance.
- If you must approach ordnance, do so at a 45 degree angle from the rear of the item.
- If you notice submunitions or landmines, assume that there are more in the area around you.
- If an item is fused and has been armed, fired, or damaged, it may be particularly hazardous. Many ordnance items include firing delays and sensors that could cause the item to detonate if approached.
- Do not be the first to open boxes or handle arms and ammunition found in combat zones, and beware of boxes and ordnance that appear to be altered, as they may have been placed as booby traps.
- Submunitions are particularly dangerous when encountered outside of packaging or their cargo munition. Do not approach or handle submunitions.

Cartridge-based ammunition

While small arms ammunition generally poses a lower risk than many other items you may encounter in the field, larger cartridge-based ammunition can be particularly dangerous. Do not approach or handle these items if:

- the cartridge has an overall length of more than 160 mm;
- the cartridge is larger than 14.5 mm in calibre;¹⁷⁴ or
- the projectile is completely painted (ARES, 2018).

¹⁷⁴ It is important to note that there are limited examples of smaller calibre ammunition containing high explosives, either as part of the projectile, or in a booby-trapped condition. See, for example, Jenzen-Jones (2014b). All ammunition should be handled with caution.

Principal tools and practices for field research on small arms and light weapons

Fieldwork takes place under a variety of conditions, from crime scenes to active conflict zones. While these circumstances all pose different challenges to an investigator, there are some general techniques that may prove useful under most conditions.

Fieldwork techniques

Depending on the area in which you are working, your affiliation, and the security situation, attempting to document arms may pose a security risk. You should make an informed assessment of the security situation before approaching combatants and seeking to document weapons. In many cases, such work is better conducted indoors, away from passers-by and civilians. However, you should not handle or move explosive remnants of war under any circumstances.

If you rely on the permission and assistance of combatants in order to conduct your work (as many journalists or non-governmental organizations (NGOs) conducting fieldwork do), you may need to convince these individuals of the importance of your work and of their assistance. If you record their name and details, or take a photo of them, you should clearly indicate how you intend to use the information or images. In most cases, there is no need to link information about arms or ammunition to their owners and it is thus possible to protect the identity of these individuals. This should be explained to anyone whose arms or ammunition you intend to record (photographically or otherwise).

If you are looking for particular arms or ammunition in a given area, you may find it useful to carry a 'scrapbook' (hard copy and/or electronic) of images of these items to show to people in the area who are less familiar with arms. Ahead of time, it is also a good idea to research local names and terminology for certain arms, and to familiarize yourself with the identification characteristics of weapons in the region. Several organizations produce reports and maintain blogs identifying arms and ammunition documented in current conflict zones, including the Small Arms Survey and Armament Research Services (ARES).

When documenting weapons, a good rule of thumb is to take twice as many photos as you need. This holds particularly true if you are under time pressure, as some images may be out of frame or focus. In the age of digital cameras and

the ready availability of storage media for them, there is rarely a need to limit the number of photos taken. If you see markings—any markings—photograph and write all of them down. Even seemingly insignificant markings often prove useful. Similarly, even if you are looking for specific arms or ammunition, you should document others you encounter, when practicable. These items may be significant for reasons that are not immediately evident.

Documenting the prices of arms and ammunition is another important facet of fieldwork. When possible, collect price data over an extended period of time (at least a few months, and preferably before the outbreak of hostilities or other key events). Data on pricing is often useful for analysing the availability and demand for various weapons. Where possible, collect price data for the same make, model, or type of items from multiple sources. Data on the unit cost of the items when sold in varying quantities, and the prices charged by different types of suppliers (individuals, professional arms dealers, businesses or groups, etc.), is also useful.

Remember to account for local idiosyncrasies in language, including how arms are classified and described. For example, the lack of a ‘p’ in the Arabic alphabet can result in ‘RPG’ becoming ‘RBG’, or ‘PKM’ becoming ‘BKM’, etc. Additionally, local fighters frequently give arms nicknames for one reason or another. For example, Syrian rebels referred to the Steyr AUG as the ‘B44’, a reference to keystrokes used to purchase this weapon in a popular computer game. In Libya in 2012, the AK-103-2 that was seen in service with both sides of the conflict was referred to as the ‘Israeli AK’, due to a mistaken belief that Israel had supplied or produced the weapons.¹⁷⁵

Site exploitation

Site exploitation (SE) is a systematic search and collection effort designed to gather primary intelligence based on information, material, and persons found at a designated location (US Army, 2010).¹⁷⁶ Site exploitation is conducted to produce a news article or intelligence report, facilitate customs or law enforcement seizures

¹⁷⁵ Interviews with ARES personnel.

¹⁷⁶ Sometimes differentiated as ‘tactical site exploitation’ (TSE) and ‘sensitive site exploitation’ (SSE) in military and law enforcement usage. TSE is sometimes considered to be a field expedient, rapid approach in comparison to the more nuanced procedures followed under SSE (Dawson, 2009).

of arms and ammunition, or support criminal prosecutions, among other reasons (ARES, 2016d).

There are a number of site exploitation and field investigation training courses that are provided to investigators within professional and governmental organizations, or from private companies. Even a short three-day course can greatly enhance investigative skills by introducing the participants to key evidence, privacy, and safety considerations; and by bolstering personal or institutional credibility.

The procedures applied during site exploitation will vary with the purpose of the field research. Chain of custody standards relating to the transfer of possession of evidence (along with other legal considerations), for example, are much stricter for criminal prosecutions than for most intelligence outputs, or for general research and reporting purposes.¹⁷⁷ The timeline for exploitation may also change substantially, depending on circumstances. Law enforcement often has several days to process a crime scene, whereas the time available for site exploitation in conflict areas may be limited to hours or minutes. While site exploitation is best conducted by a team of investigators, individuals may sometimes need to collect evidence on their own. As noted above, researchers should obtain appropriate training from their organization or elsewhere before engaging in site exploitation.

Researchers should be aware of the possible ramifications of contaminating a crime scene or disturbing evidence. Anyone engaging in these activities will ultimately need to take personal and, as relevant, organizational responsibility for the decision to access crime or conflict areas and document arms and ammunition. If items are moved—either to allow for better photography, or for evidentiary or other purposes—additional factors must be considered.

The following basic principles of site exploitation are adapted from an ARES training module, and are presented as an introductory overview only.

Searching the site

Site exploitation provides access to three broad categories of primary intelligence:

- **information** gathered from physical documents, books and manuals, computer hard drives, external storage devices, and other media;

¹⁷⁷ See, for example, van Ginkel (2012); Roach (2009).

- **materiel**, including weapons, ammunition, equipment, chemicals, and supplies; and
- **persons** including witnesses, victims, and others.

These primary sources are known by the acronym IMP (information, materiel, and persons) (US Army, 2010).¹⁷⁸

Basic site searches consist of the following steps:

- Conduct a risk assessment.
- Identify safety hazards.
- Search the area to locate primary intelligence sources (IMP).
- Document the site and evidence.
- Question human intelligence sources.
- Conduct further forensic collection, if applicable (ARES, 2016d).

Before applying invasive search techniques, investigators should thoroughly document the site. The purpose, sensitivity, and significance of the site should be assessed. In addition to extensive photography of the site and the gathering of relevant intelligence, the following four practices may also be helpful.

A **sketch** of the area under investigation can prove very useful when attempting to recreate the scene from photographs at a later date, and for recording important dimensions (see Image 7.1). Sketches are used to assist in recalling the layout of a scene. The sketch should support the photographs, with items drawn appropriately sized, but not necessarily exactly to scale. A sketch should show where evidence was found in relation to the area of investigation, including the physical address and GPS coordinates of the area. The researcher may also consider drawing a grid, so as to quickly identify areas of the scene in question. Reference landmarks may also be included. Sketches should always be digitized (scanned or photographed in high resolution) in case the original is lost or damaged. Under field conditions, even a quick photograph of a site sketch is better than none at all. Alternatively, some mobile devices have softwares that can be

¹⁷⁸ Other specialists with experience in technical intelligence (TECHINT) exploitation, post-blast analysis, EOD, human intelligence collection/interrogation, or forensic collection may be present or available in some circumstances, and this may expand the scope and goals of the collections effort accordingly.

Image 7.1 A hand-drawn site exploitation sketch

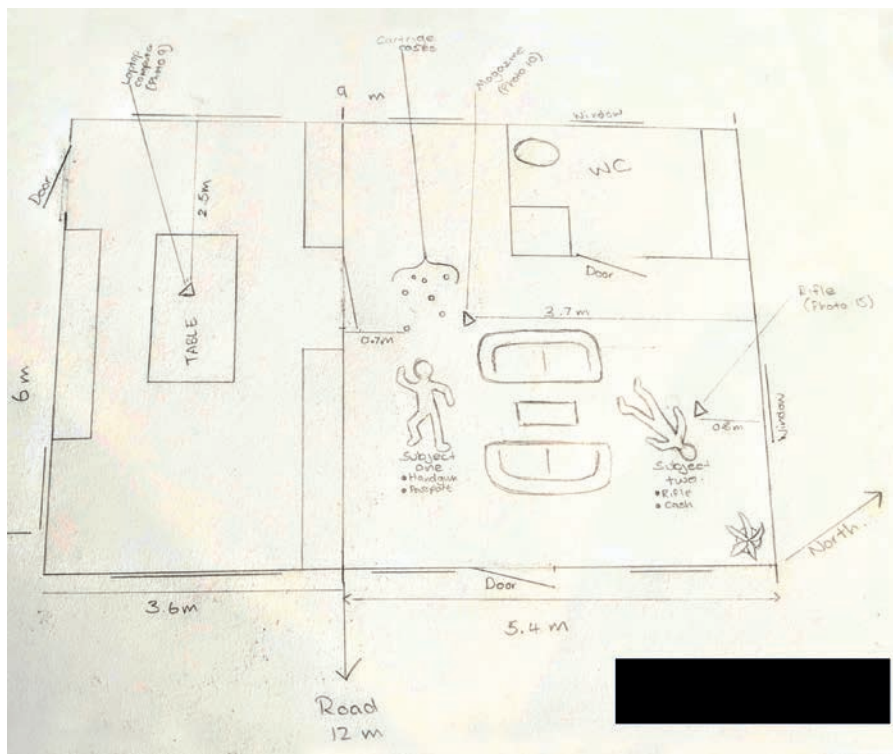

Source: Bethany Granton/ARES

used for this purpose, although sketching on phone or computer screens is often more time consuming and less accurate than a quick, hand-drawn sketch.¹⁷⁹

In Image 7.1, an investigator has sketched a site where two bodies and relevant intelligence sources (firearms, a magazine, fired cartridge cases, passports, cash, and a laptop computer) were recovered. The sketch is quite good, including a cardinal direction (north), reference walls (walls of known/measured length), doors and windows, locations of recovered evidence (including the distance from nearest reference wall), distance to landmarks (road), and references to photos of the evidence items. The redacted (blacked-out) portion at bottom right also contained information on location, including GPS coordinates, and identified the

¹⁷⁹ For further information on data recording during site exploitation, see ARES (2016d).

author of the sketch (ARES, 2016d). The sketch could be improved by linking it more closely to photographs of the scene. For example, if photographs were taken from each corner of the rooms, the photograph numbers could be labelled on the sketch, and photographs of all evidence items and bodies could be listed.

In addition to a sketch, taking a **digital video** of the scene is an excellent way to show the relationship between evidence items, and serves as a backup inventory of the items. The video does not need to be overly long or attempt to identify the weapons in a single cut, but should capture all items present. A digital video also helps to show that investigators have sought to preserve the scene. Generally, the same principles apply to videography as to photography: items should be clear, in focus, and well lit where possible. Ideally, video should be shot in landscape format.

Interviews with relevant persons ('human intelligence sources') are another important source of information about arms and ammunition. Interviews are often conducted through an interpreter, who may need to be briefed on relevant arms-related terminology, if they are not already familiar with it.

Context is essential when documenting arms and ammunition. Some relevant information can be inferred by examining your surroundings, but it is often useful to ask the possessor or owner of a weapon for details about the weapons (assuming it is safe to do so). Possible questions include the following:

- How, where, and when did the possessor/owner obtain their weapon?
- How, where, and when was the weapon used?
- How common are arms of this type?
- How common are magazines or ammunition for the weapon?
- What are weapons like this worth in the conflict zone? Are they available for purchase?
- Do they know of weapons being supplied from or sent to other countries?
- What kinds of weapons are popular, and why?

Legal and forensic considerations

In addition to the safety and intelligence gathering considerations outlined in this chapter, there are often legal and forensic considerations which must be taken into account before documenting arms and ammunition under field conditions. Researchers are advised to make a full and informed appraisal of the local secu-

rity situation—including potential legal or administrative restrictions—before conducting any research related to arms or ammunition. These considerations will vary with the nature of the research and the area in which it is being conducted. In many jurisdictions, entering any crime scene without permission, for example, may be prohibited and carries a hefty penalty. In certain conflict situations, however, field researchers may be the only way that investigators can document particular items or events. In all cases, researchers should follow the policies and procedures established by their organization, and adhere to applicable local, national, and international laws and regulations.

As a general rule, refrain from touching or removing items. If items must be moved, wear non-porous gloves (latex or nitrile are commonly available; nitrile is less prone to causing allergic reactions). Evidence should be placed in sealed bags, and steps should be taken to preserve it. If items are to be used as evidence, then chain of custody and evidence storage procedures should be established and followed. While these procedures are largely beyond the scope of this Handbook, the following information should at least be collected:

- time, date, and location where evidence was gathered;
- reason evidence was collected (case file number, etc.);
- other administrative data (item number, investigator ID, etc.);
- description of the item in question;
- information on the chain of custody (ARES, 2016d).

At any point, one individual will have control (custody) of a given piece of evidence. When any change in custody occurs, the individual in control of the evidence at that time should note the change in custody on a form accompanying the item and, ideally, on a master chain of custody record sheet. Acknowledging the change with the signatures of both parties is good practice. Evidence should also be stored in a secure location. Under field conditions, this may include a hotel safe, locked vehicle, or a similarly expedient solution.

Potential sensitivities regarding arms and ammunition information gathering

Gathering information about arms and ammunition can be a sensitive and potentially perilous undertaking. Of particular concern are situations in which:

- parties in possession of the items in question assume that a researcher is acting as an intelligence gatherer for opposing forces or other hostile parties;
- the item in question is part of a covert nation state programme to arm the recipients, making the possessor reluctant to allow documentation of the item;
- possession of the item in question is a violation of ceasefire terms or arms limitations negotiated between the parties in question;
- subgroups of an armed party to the conflict have access to limited stocks of more effective or prestigious items than the parent organization, potentially causing friction between the groups if the parent organization learns of these stocks;
- the item in question is related to activities that the possessor wishes to conceal, such as criminal acts or covert operations;
- the quality or lack of certain arms and ammunition is interpreted as a lack of resourcing and causes a group to lose a tactical advantage, prestige, or negotiating position.

In such cases, investigators should carefully consider whether interviewing the source in question is advisable.

Photographic considerations

In broad terms, most modern digital cameras will suffice for taking images of arms and ammunition. Photographs should:

- be clear, sharp, and free of distortion;
- be taken from a stable position;
- include the date, time, and location when photographs were taken (digital cameras should be correctly programmed for the date and time) (ARES, 2016d).

At the most basic level, you should attempt to photograph items in areas where the light is even throughout, so as not to render part of your composition too light or too dark. Direct sunlight should be avoided, where possible. You should be familiar with the macro function, where present, for taking images of small details such as cartridge headstamps.

Where necessary, you may want to use a tripod, or, when a tripod is unavailable, brace your camera against a suitable item to steady it. Steadying the camera is particularly helpful in low light situations. Your camera's flash may be useful

in some circumstances but may wash out items if improperly employed. When in doubt, take several photos both with and without the flash. If using a digital camera, always check your images after taking them to ensure they are clear and in focus.

Photographic record checklist

Below is a checklist for photographing small arms and light weapons for the purposes of identification. This list is not in order of priority, nor is it exhaustive or specific to certain weapons. If you have limited time or opportunity to photograph a particular weapon, the most important photos to take are a profile shot, and a photograph of markings on both sides of the main body (receiver, frame, or housing) of the weapon (see Figure 7.1).

- Profile shot (left side)
- Profile shot (right side)
- Magazine(s)
- Muzzle and barrel (especially muzzle attachments)
- Weapon model/type markings
- Factory markings
- Serial number markings
- Selector markings
- Sight markings
- Proof marks
- Any additional markings on the weapon
- Any accessories or mounts
- Any markings on accessories or mounts
- Packaging
- Contextual photos of the user, storage facility, or surroundings

When photographing ammunition, the most essential photo to take is of the headstamp. An image of the profile is the next most useful, followed by photographs of other markings, packaging, and contextual photos of the user, storage facility, or surroundings. Photographs of ordnance should include a profile shot, as well as any markings (including coloured bands or symbols) or obvious phys-

ical characteristics (fins, fuses, etc.). Photos of packaging should include the interior and exterior, with particular attention paid to markings. When items of interest are located in a container, hiding place, or vehicle, images should be taken to provide proper context (CALL, 2007, pp.63–68; ARES, 2016d).

To document scale, a photographic point of reference such as a small ruler with high-contrast markings is ideal.¹⁸⁰ Other household items that are useful for this purpose include, but are not limited to, common cigarette lighter designs, packs of cigarettes, and CDs. Regardless of which item is used, the photographer should record the measurements of the item. It is best to take several photos both with and without the points of reference.

In addition to photographing the arms, ammunition, and other items identified above, take photos of:

- the entire area or room containing evidence (when possible, take a 360-degree exposure of the four corners of the room);
- each piece of suspected evidence, with and without the point of reference (small ruler etc.);
- a reference point for calculating the physical dimensions of the site, building, and any items collected,¹⁸¹ and
- a broad point of view that establishes the location of arms and ammunition by including landmarks or reference points (ARES, 2016d; CALL, 2007, pp. 63–68).¹⁸²

Storing your images

It is essential that you keep a backup copy of your images to ensure that valuable data collected in the field is not lost because of misplaced storage devices or hard disk failure. Three copies of important information is generally a good standard—one saved on your primary computer or device, a second on a portable hard drive or similar device, and a third on resilient media such as a DVD or ruggedized

180 This is sometimes known as a ‘photographic fiduciary’ or ‘forensic reference’.

181 Such images may prove useful for photogrammetry and other purposes. See, for example, Jespersen (forthcoming).

182 In certain circumstances you may also want to take photographs of people; however, this comes with attendant privacy protection and legal considerations. Your organization should provide guidance in this matter.

Figure 7.1 Markings on AK-type rifles

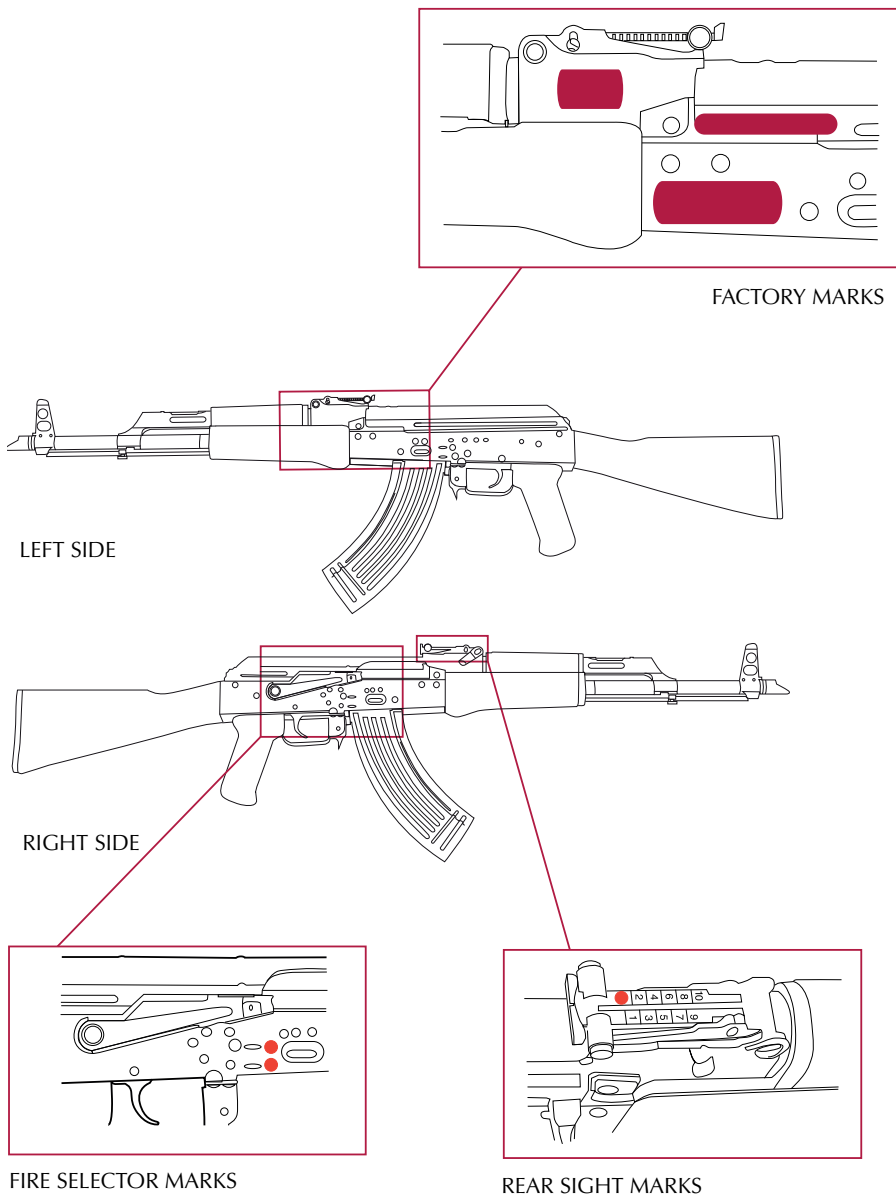

Source: ARES

USB drive. Data can also be backed up to the Cloud, but doing so may pose security concerns that should be carefully assessed. If you are working with digital images, make as few changes as possible. Changes to colour and perspective, for example, can impede the identification process. In any case, you should always keep copies of the original, unmodified images for data verification purposes.

Case study: AK-103 and F2000 self-loading rifles in Gaza¹⁸³

1. Lead generated from open-source intelligence

On 2 October 2012, the al-Quds Brigades, the armed wing of Palestinian Islamic Jihad, held its annual military parade in Southern Gaza to mark the 17th anniversary of the assassination of the group's founder, Fathi al-Shaqaqi. The group often uses these parades to display its latest arms and ammunition acquisitions. In 2012, among the usual assortment of Soviet- and Chinese-designed rifles and machine guns were two self-loading rifles not previously documented in Gaza: the Belgian F2000 (see Image 7.2) and the Russian AK-103. These two rifles, which are relatively modern and had rarely been seen together in the hands of a single fighting force, constituted significant 'flag items'—items that are likely to provide ready indicators of diversion or other illicit activity.

2. Preliminary identification

Analysts from ARES became aware of these rifles shortly after the parade and conducted a preliminary analysis. The F2000, being visually distinct from other self-loading rifles, proved easy to identify. While there are airsoft and non-firing replicas of these weapons, physical characteristics of the F2000 rifles—and the group displaying them—made it likely that these were lethal-purpose weapons. The AK-103 required additional analysis. The rifle is one of the so-called 'AK-100' series of rifles, designed and introduced by the Russian company IZHMAASH (now Kalashnikov Concern) in the early 1990s.¹⁸⁴ Its mechanical design—and

¹⁸³ This case study is adapted from Jenzen-Jones (2015e) and Jenzen-Jones (2016c).

¹⁸⁴ The so-called AK-100 series is generally considered to be comprised of the AK-74M, AK-101, AK-102, AK-103, AK-104, and AK-105. There is no rifle designated the 'AK-100' (Ferguson and Jenzen-Jones, 2014b). Further developments include rifles such as the AK-9, chambered for 9 × 39 mm (Jenzen-Jones, 2012a).

Image 7.2 Palestinian Islamic Jihad al-Quds Brigades member with Belgian FN Herstal F2000 self-loading rifle, fitted with LG1 under-barrel grenade launcher, in Gaza, 2 October 2012



Source: Palestinian Islamic Jihad al-Quds Brigades

general appearance—is very similar to the AKM, an updated AK series rifle introduced in 1959, and other AK-type rifles (Jenzen-Jones, 2012a; Ferguson and Jenzen-Jones, 2014b).

None of the markings on the AK-103s were visible in the early images from Gaza, so analysts had to identify the rifles by their physical characteristics alone. The AK-100 series rifles are visually distinctive from earlier models of AK-type rifles, allowing analysts to rule out all but six models: the AK-74M, AK-101, AK-102, AK-103, AK-104, and AK-105. These models share several key physical characteristics, including the same black synthetic furniture and magazines, and black phosphate finish on metal parts. Analysts then compared the barrel length and muzzle devices of the six rifles, which shortened the list of possible matches to three models: the AK-74M, AK-101, and AK-103. These models have barrels that are roughly 100 mm longer than the AK-102, AK-104, and AK-105, which also have distinctive muzzle devices (Jenzen-Jones, 2012a).

Distinguishing between the three remaining models was more difficult. All are full-length rifles in the AK-100 series and are fitted with the same muzzle

brake, side-folding solid polymer stock, and left-hand side optical sight rail (Ferguson and Jenzen-Jones, 2014b). A feature-by-feature comparison was required to identify the model of the rifle.

3. Achieving positive identification

The key feature that readily distinguishes the AK-103 from other AK-100 series rifles is the distinctive profile of its magazines (see Image 7.3). Unlike the AK-101 (top) and AK-74M (centre) which are chambered for cartridges with minimally-tapered cases, the AK-103 (bottom) is chambered for the 7.62 × 39 mm cartridge, which are held in a magazine with a much more curved profile. Note the relative proximity of the blue and green lines, compared to the pink, and the distinctive ‘banana’ shape of the AK-103 box magazine.

Image 7.3 Comparative study of AK-101 (top) with magazine profile marked in purple, AK-74M (centre) with magazine profile marked in yellow, and AK-103 (bottom) with magazine profile marked in grey¹⁸⁵



Sources: Rob Stott; Concern Kalashnikov

¹⁸⁵ There is minor image distortion and perspective difference between the three source images, so this image should not be considered perfectly precise. Nonetheless, it remains indicative of the difference in magazine profiles between the three rifles.

Available images did not allow analysts to determine whether the rifles were the more common AK-103 model, or AK-103-2 variants. Distinguishing an AK-103 from an AK-103-2 requires an examination of a rifle's markings or internal components, which were not visible in the earliest available images from Gaza (ARES, n.d.). The analysts needed more information about the rifles but there was no guarantee that Gazan militants would post additional photos, let alone photos of the markings. With limited resources to reach out to sources in Gaza, the analysts had to look elsewhere. The most likely source of the additional information was Libya, where both the AK-103-2 and the F2000 had recently been documented.

4. Identifying the variant of the AK-103, and the source of the rifles

Analysts then sought to conclusively determine whether the F2000 and AK-103 rifles in Gaza had been trafficked out of Libya. To that end, ARES attempted to: (1) confirm the variant of the AK-103 rifles in Libya; (2) determine whether Libya was the source of the AK-103 and F2000 rifles spotted in Gaza; and (3) identify the point at which the rifles were diverted into the illicit sphere.

Analysts, including a native Libyan Arabic speaker, sought more information regarding these weapons from well-placed individuals in Libya. They conducted numerous interviews with these and other sources, including international specialists, and obtained images of AK-103 and F2000 rifles from individuals connected to the black market arms trade, including the online black market. Several of these images showed detailed markings and serial numbers (ARES, n.d.). The markings revealed that the AK-103 rifles in Libya were the AK-103-2 variant.

The serial numbers were then compared to existing photographic and documentary evidence held by ARES. This allowed analysts to confirm that the photographed examples were part of the original contracts and shipments known to ARES. In the case of both rifle models, the weapons in question were part of authorized exports to the Libyan government (Jenzen-Jones, 2016c).

Analysts then attempted to determine whether the rifles in Gaza came from Libya and, if so, how they ended up in the hands of Gazan militants. Interviews with individuals in Libya were a key part of this process. Ali,¹⁸⁶ a former student who joined the rebel movement during the 2011 Civil War, told ARES how he and a group of young fighters he led came across a large, strange-looking rifle

¹⁸⁶ All names used in this case study are pseudonymous, to protect sources in Libya.

Image 7.4 Ali and his fellow fighters during the 2011 Libyan Civil War



Note: Left and centre: F2000 self-loading rifles; second from right: AK-103-2.

Source: ARES/confidential source

known to them as ‘the French FN’ (see Image 7.4). They had seized two of them from retreating loyalist forces on the southern outskirts of Sabha in September 2011. Ali explained:

We had a checkpoint just outside of Sabha. A car came up and the window rolled down. The man told us he was an officer from the 32nd Brigade and we were to let them past. We didn't have any revolutionary flags at the time, so maybe they thought we were with Gaddafi's forces.

In total, Ali's unit seized two F2000 and two AK-103-2 rifles.

At the end of the 2011 Civil War, some of the captured AK-103-2 and F2000 rifles found their way north, to the port city of Misrata. Ali handed over his F2000 to the new government, and another fighter named Marwan turned over two AK-103-2 rifles. However, many combatants kept their weapons, while others sold them or traded them for more concealable weapons such as handguns. Khaled, another individual interviewed by ARES, operated a successful black market arms business in Misrata. Khaled told ARES that he was directly responsible for the shipment of AK-103-2 and F2000 rifles to Gaza. ‘We sent them to help the people of Gaza,’ he said. The weapons in question were not sold, but gifted to a contact in Gaza to demonstrate solidarity against Israel. Just as the Belgian FN Herstal F2000 had been widely misidentified by Libyan rebels as the ‘French FN’, the AK-103-2 was widely known in 2012 as the ‘Israeli Kalashnikov’. The analysts had their answer: the rifles spotted in Gaza had indeed come from Libya.

5. Mapping the chain of custody

Earlier investigations into the presence of these weapons in Libya had turned up multiple images of packaging crates from different sources, including newspaper accounts, social media, and confidential sources in Libya. These images showed contract numbers and shipping information for the AK-103 rifles, which, in turn, allowed analysts to more fully map the chain of custody of the weapons.

Of particular interest were Russian and Belgian shipping documents obtained by Human Rights Watch in 2011 and provided to ARES in 2012. The contract numbers on the Russian shipping documents matched those on the packaging crates for AK-103 rifles. These sources reveal that the AK-103 rifles were part of a sizeable arms deal between Russia and Libya concluded in late 2003 or early 2004. The rifles were delivered from 2004 onwards. The F2000 rifles formed part of a smaller, but still significant, arms deal between Belgium and Libya, which was signed in May 2008 and completed in 2009. The shipping documents and images of the packing crates were the final pieces of the puzzle. Starting with a few photos of unusual rifles displayed during a military parade, the analysts were able to not only identify the make and model of the weapons but also trace their circuitous, multi-year journey from factories in the Russian Federation and Belgium to the streets of Gaza (see Map 7.1).

6. Assessing further proliferation and providing context

At the same time that analysts were conducting interviews to determine trafficking routes of the rifles displayed by the Palestinian Islamic Jihad, ARES was also gathering additional information about the proliferation of these rifles in Gaza and other parts of the Middle East and North Africa (see Map 7.1). This research revealed further proliferation of both the AK-103 and F2000 rifles.¹⁸⁷ Fighters from the armed wings of Hamas, the Democratic Front for the Liberation of Palestine (DFLP), and the Popular Resistance Committees (PRC) have also been pictured with AK-103 type rifles on numerous occasions (see Images 7.5 and 7.6). Several of the rifles were also identified in the hands of members of the Preventive Security Force of the Palestinian National Authority. In a small number of cases, AK-103-2 variant rifles were identified (ARES, n.d.).

¹⁸⁷ The Palestinian Islamic Jihad's al-Quds Brigade have continued to parade these weapons; both the AK-103 and F2000 were concurrently documented in their possession during a parade in August 2015, for example.

Image 7.5 An AK-103 rifle in the hands of a militant from the National Resistance Brigades of the Democratic Front for the Liberation of Palestine, Gaza, 2014



Source: DFLP

Image 7.6 The same model of rifle with militants from the 'naval commando' unit of the Izz ad-Din al-Qassam Brigades of Hamas in Gaza, 2014



Source: Mahmud Hams/AFP Photo

Image 7.7 AK-103 rifles in the hands of Islamic State fighters in Libya, 2015¹⁸⁸



Image 7.8 AK-103-2 rifle documented for sale via social media in Iraq, 2016



Source: ARES/confidential source

.....
188 Source withheld

Map 7.1 Mapping the proliferation of AK-103 type rifles connected to Libya

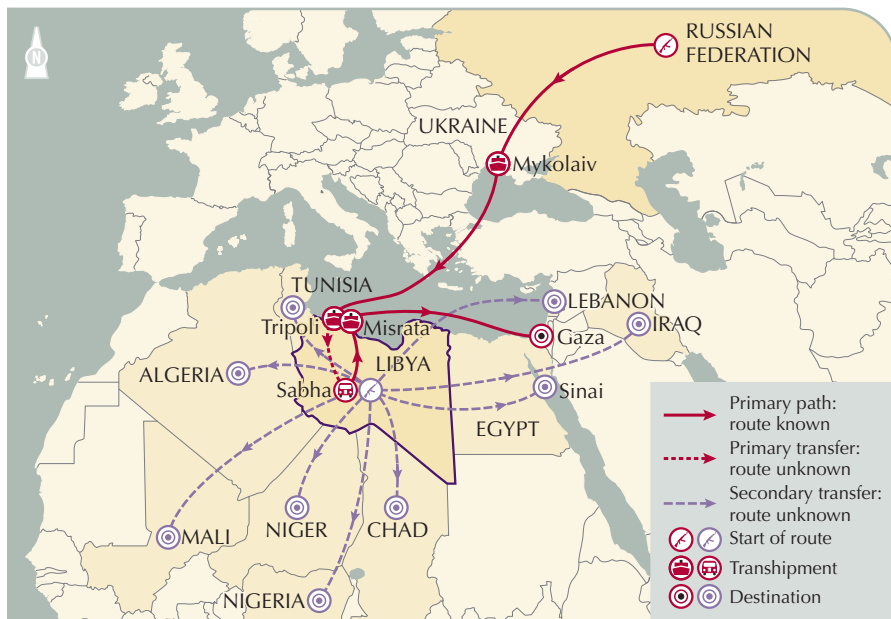

Source: Jenzen-Jones (2016c); ARES (n.d.)

Reports from the UN Panel of Experts on Libya indicate that AK-103 rifles have also been documented in Mali, Tunisia, and Niger (see Map 7.1). Islamic State forces in Libya have also made use of the AK-103; several were visible in a video showing the execution of Ethiopian Christians in Libya in 2015 (Image 7:7). Subsequent ARES investigations have turned up AK-103 type rifles, including AK-103-2 models, in Algeria, Chad, Egypt, Iraq, Lebanon, Mali, Niger, Nigeria, and Tunisia (ARES, 2016a; 2016b; Jenzen-Jones, 2016b; see Image 7.8). F2000 rifles were documented in the hands of militants in Egypt's Sinai Peninsula in 2015. As with the F2000 rifles documented in Gaza, they were fitted with 40 × 46SR mm LG₁ under-barrel grenade launchers. Given their distinctive physical appearance and relative scarcity in many areas, these rifles will continue to constitute flag items for investigators examining current and future conflicts.

— Author: N.R. Jenzen-Jones

CHAPTER 8

Analysing Arms Flows: Authorized Transfers

Introduction

Never before has there been so much data on arms flows. The rapid expansion of camera-equipped smartphones, Internet connectivity, and digital file-sharing platforms has exponentially increased the amount of publicly available data on arms transfers and illicit weapons. Postings on social media provide near real-time information on weapons acquired by a wide array of armed actors, from elite military units to violent extremists. A concurrent expansion in field research by the UN and NGOs has yielded complementary data on small arms in conflict zones, including in areas where social media postings are less frequent.¹⁸⁸ When analysed alongside traditional sources of information on the arms trade, this new data provides unprecedented insight into the movement of weapons across borders and between regions.

Journalists and researchers play an indispensable role in gathering, interpreting, and disseminating this data. By linking it to broader geopolitical and security issues, they can convert this data and analysis into meaningful information for lay audiences.

The purpose of this chapter is to provide an overview of sources, strategies, and techniques for analysing authorized arms flows throughout the transfer chain.¹⁸⁹ The chapter begins with a brief assessment of several key data sources on small arms transfers, including their strengths and limitations. Guidance on how to interpret this data is also provided. The chapter concludes with suggestions for corroborating initial findings and confirming individual data points.

Sources of data on authorized small arms transfers

As defined by the Small Arms Survey, the term ‘authorized arms transfers’ refers to ‘international transfers that are authorized by the importing, exporting, or transit states’ (Dreyfus, Marsh, and Schroeder, 2009, p. 9). The main categories of data sources on authorized arms transfers are: government agencies, UN institutions, field research, industry literature, and social media (see Table 8.1). Data from these sources is disseminated through various online databases, reports, and websites. This chapter focuses on five of the most important sources: national reports on arms transfers, United Nations Commodity Trade Statistics Database

¹⁸⁸ See, for example, UNSC (2016) and Anders (2015).

¹⁸⁹ Chapter 9 looks at illicit (non-authorized) arms flows.

(UN Comtrade) and other sources of customs data, the UN Register of Conventional Arms ('the UN Register', or UNROCA), social media, and tenders and contract award notices.

Data on authorized transfers in these sources is vast. Customs data submitted to the UN Statistics Division includes records on millions of weapons transferred to and from dozens of countries worldwide. Thousands of additional records are published each year in the UN Register, national reports, and annual reports required by the Arms Trade Treaty (ATT). Table 8.1 lists these sources and the availability of data for each link of the transfer chain

Before unpacking these data sources, a brief overview of key terms is required. The term 'government data' refers to country-specific data generated and made available by government entities, including customs and export control agencies.

Table 8.1 Sources of data on authorized transfers

Data source		Exports	Re-exports	Domestic retransfers	End user [§]
Government agencies	National reports	✓	✓		✓
	Parliamentary reports	✓	✓		✓
	Tenders/contract award notices	✓			✓
Multilateral instruments	Regional reports	✓	✓		✓
	ATT annual reports	✓	✓		✓
	UN Comtrade	✓	✓		
	UNROCA	✓	✓		✓
	UN Panel of Experts reports	✓	✓	✓	✓
Other	Commercial trade data aggregators	✓	✓		✓
	Field research*	✓	✓	✓	✓
	Industry literature**	✓			
	Social media	✓	✓	✓	✓

Notes:

✓ Indicates that the data source frequently provides usable information in this category.

✓ Indicates that the data source occasionally provides usable information in this category.

§ For the purposes of this table, 'end user' refers to the specific private, commercial, or government agency that is the intended recipient of the transferred items.

* This subcategory includes field research by NGOs and inter-governmental organizations other than the UN Panel of Experts, which are categorized separately.

** Industry literature includes annual corporate reports, company websites, press releases, etc.

It consists of data on: (1) potential transfers; and (2) actual transfers. Potential transfers are proposed imports or exports that have been approved by the relevant government agencies but have not been shipped to the recipient. Arms export licences are examples of sources of data on potential transfers. Actual transfers are those in which the exported items have been delivered—or are en route—to the recipient. Records of arms shipments passing through the ports of entry or exit (customs data) are examples of data on actual transfers.

Another term that is frequently used in the literature on arms transfers is ‘mirror data’, which consists of records on arms exports published by importing governments (and records on arms imports published by exporting governments).¹⁹⁰ Nigerian records of imports of arms from China are an example of mirror data on Chinese exports (see Figure 8.4). Mirror data is useful for studying arms transfers to and from countries with non-transparent governments. In theory, this data could also be used to corroborate data from trade partners but, in practice, records from exporters and importers rarely align, even for transfers between countries with transparent governments. This curious (and often vexing) quirk of arms trade data is explained by several factors, including differences in data gathering and reporting methodologies, selective reporting, and erroneous data (Holtom, 2008). Without access to bills of lading and other commercial and official export documentation, determining the reason for a specific discrepancy and reconciling the data is extremely difficult, if not impossible.

Analysing national reports

Annual reports on arms transfers published by individual governments—often referred to as ‘national reports’—have been a mainstay of arms trade research for many years.¹⁹¹ Several dozen governments publish national reports, which vary in scope, specificity, and completeness. The data in some reports is clear and detailed while data in others is over-aggregated or reported under ill-defined commodity categories.¹⁹² Figure 8.1 is an excerpt from Albania’s 2014 annual report,

¹⁹⁰ See UNSD (n.d.a).

¹⁹¹ Some countries, such as the Netherlands, publish data on their arms transfers on a monthly basis (Netherlands MFA, n.d.).

¹⁹² The Small Arms Survey’s annual Transparency Barometer includes a list of major exporting states that publish national reports (Small Arms Survey, n.d.b).

Figure 8.1 Excerpt from Albania's national report on exports of military goods, 2014

26		STATE EXPORT CONTROL AUTHORITY			
		Annual Report on Export Control for 2014			
<i>Annex 1</i>					
LICENSED AND COMPLETED EXPORTS OF MILITARY GOODS IN 2014					
End User State	NR	Control List Code	Type of good	Value based on license	Valued Realization for 2014 - 2015
Austria	1	ML 1	SKS Rifle M-56	918.400 \$	119.720 \$
		ML 3	Ammunition Cal 7.62x39 mm	171.000 \$	170.964 \$
		ML 3	Ammunition Cal 7.62x54 mm	165.000 \$	69.854 \$
Total	1			1.254.400 \$	360.538 \$
Bulgaria	1	ML 3	Mortar Shells 120 mm	900.000 \$	300.000 \$
		ML 3	Mortar Shells 80 mm	300.000 \$	0 \$
		ML 3	Projectile 122 mm Howitzer	4.000 \$	0 \$
		ML 3	Fuse M-12	14.292 \$	0 \$
Total	1			1.218.292 \$	300.000 \$
Republic of Kosovo	1	ML3	Ammunition Cal 9 x 19 mm	23.000 \$	23.000 \$
Total	1			23.000 \$	23.000 \$
Czech Republic	1	ML 3	Ammunition Cal 7.62x39 mm	1.500.000 \$	920.160 \$
	1	ML 3	Ammunition Cal 7.62x39 mm	600.000 \$	599.997 \$
	1	ML4	TNT demolition Charges	990.000 \$	0 \$
	1	ML 3	Ammunition Cal 12.7 x 108 mm	600.000 \$	600.000 \$
		ML 3	Ammunition Cal 14.5x114 mm	75.000 \$	75.000 \$
		ML 3	Ammunition Cal 7.62x54 mm	160.000 \$	160.000 \$
Total	4			3.925.000 \$	2.355.157 \$
Iraq	1	ML 3	Ammunition Cal 7.62x56 mm	0 \$	Total
		ML 3	Hand Grenades		
		ML 3	Mortar Shells 60, 82, 120 mm		
		ML 3	Shells 40 mm GHLKT		
		ML 1	Automatic Rifle		
	1	ML 2	GHLKT 40 mm	0 \$	Total
		ML 2	Mortars 60 mm		
		ML 2	Hand Machine Guns		
Total	2			0 \$	Total

Source: Albanian MOD (2014, p. 26)

which is one of the more detailed reports published in recent years. It provides data on importing countries, values of issued licences and deliveries, and descriptions of the exported items, including the type, model, and/or calibre.

Table 8.2 EU Common Military List, categories 1 to 4

ML 1	Smooth-bore weapons with a calibre of less than 20 mm, other arms and automatic weapons with a calibre of 12.7 mm (calibre 0.50 inches) or less and accessories, and specially-designed components thereof.
ML 2	Smooth-bore weapons with a calibre of 20 mm or more, other weapons or armament with a calibre greater than 12.7 mm (calibre 0.50 inches), projectors and accessories, and specially-designed components thereof.
ML 3	Ammunition and fuse setting devices, and specially-designed components thereof.
ML 4	Bombs, torpedoes, rockets, missiles, other explosive devices and charges and related equipment and accessories, and specially-designed components thereof.

Source: EU (2017, p. 6)

Figure 8.2 Excerpt from the EU's annual report on imports and exports of military goods and technologies, 2015 (exports to Iraq)

Iraq

		ML1	ML2	ML3	ML4	ML5	ML6	ML7	ML9
France	a	2	6	2	5	1	2	2	
	b	8 555 282	18 997 431	79 000 000	483 462 000	675 700 000	14 710 000	48 100 000	
	c								
Germany	a	3	2	3	6		6	4	
	b	403 661	80 889	5 039 257	16 012 138		3 239 084	1 567 313	
	c								
Italy	a	4							
	b	14 210 000							
	c								
Poland	a								
	b								
	c		2 496 731	50 224 238					
Portugal	a								
	b								
	c	96 594		49 310		18 357			
Slovakia	a	1			1				
	b	120 000			13 380 000				
	c								

Note: In this table, 'ML' refers to the categories of the EU's Common Military List, 'a' refers to the number of licences issued, 'b' refers to the value of licences issued in Euros, and 'c' refers to the value of arms exports in Euros.

Source: EU (2017, p. 158)

Table 8.3 Strengths and limitations of national reports

Best for:	Less useful for:	Caveats:
<ul style="list-style-type: none"> ■ Researching arms exports from Europe, North America, and some countries in the Pacific. ■ Identifying and tracking potential (authorized) arms transfers. 	<ul style="list-style-type: none"> ■ Monitoring and measuring global and regional trends. ■ Studying arms transfers between most countries in Africa, Asia, the Middle East, and Central and South America. ■ Identifying end users of exported arms. ■ Researching shipping methods and modes of transport. 	<ul style="list-style-type: none"> ■ Some reports only include data on potential transfers and not actual transfers (deliveries). ■ Some reports are published only in the official language of the reporting country. ■ Researchers have discovered significant errors in some reports. ■ National reports may not include data on all transfers. ■ Commodity category descriptions may be misleading or poorly defined. ■ There are often significant lags between transfers taking place and publication of corresponding data in national reports.

Source: Dreyfus, Marsh, and Schroeder (2009, p. 27)

Many states, including most European states, report on export data using categories corresponding to the Wassenaar Arrangement's Munitions List and/or the EU's Common Military List (ML) (see Table 8.2 and Figure 8.2). The most relevant categories for small arms and light weapons are ML 1 to ML 4.

Analysing UN Comtrade and other customs data

Records of small arms shipments generated by customs agencies are another important source of government data on arms transfers. Customs data is typically collected when an arms shipment passes through the ports of exit (exports) and entry (imports).¹⁹³ The largest source of customs data is the UN Commodity Trade Statistics Database (UN Comtrade), a repository of nearly one billion records on imports and exports of various items submitted to the UN Statistics Division since 1962 (UNSD, n.d.b). The data is aggregated and displayed under standardized,

¹⁹³ In a 2006 survey of 132 governments conducted by the UN Statistics Division, approximately 88 per cent indicated that customs declarations were the main source of data used in the compilation of trade statistics (UNSD, 2008, para. 1.5).

Table 8.4 Selected Harmonized system (HS) commodity categories that include small arms, light weapons, ammunition, parts, and accessories

Item type	HS code	HS description*	Comments*
Small arms	930190	Military weapons, other than revolvers, pistols and arms of heading 93.07 <ul style="list-style-type: none"> ■ Other 	<p>Includes:</p> <ul style="list-style-type: none"> ■ machine guns; military rifles; military shotguns; sub-machine guns; and other arms 'capable of continuous and very rapid fire'; ■ weapon sights mounted on or presented with the firearm at the time of export; ■ firearms that are designed to form part of vehicles but are exported separately from the vehicles. <p>Excludes:</p> <ul style="list-style-type: none"> ■ collectors' pieces and antiques. <p>Note: This is a catch-all subcategory and includes items other than small arms and light weapons.</p>
	930200	Revolvers and pistols, other than those of heading 93.03 or 93.04	<p>Includes:</p> <ul style="list-style-type: none"> ■ revolvers and pistols of any calibre; ■ hand-held firearms designed to look like other objects (e.g. pencils, pocket knives, cigarette cases). <p>Excludes:</p> <ul style="list-style-type: none"> ■ captive-bolt type humane killers; sub-machine guns ('continuous fire weapons'); flare guns; starter pistols and other blank-fire weapons; muzzle-loading and black powder pistols that do not fire cartridges; and spring, air, and gas pistols.
	930310	Muzzle-loading firearms	<p>Includes:</p> <ul style="list-style-type: none"> ■ muzzle-loading ('black powder') firearms that are 'neither designed for nor capable of firing a cartridge'.
	930320	Other sporting, hunting or target-shooting shotguns, including combination shotgun-rifles	<p>Includes:</p> <ul style="list-style-type: none"> ■ single-shot and semi-automatic sporting and hunting shotguns of all calibres, including those with one smooth-bore and one rifled barrel; ■ weapon sights presented with the firearm at the time of export.

Item type	HS code	HS description*	Comments*
Small arms (continued)	930330	Other sporting, hunting or target-shooting rifles	<p>Includes:</p> <ul style="list-style-type: none"> ■ single-shot and semi-automatic sporting and hunting rifles of all calibres; ■ weapon sights mounted on or presented with the firearm at the time of export.
Light weapons	930120	<p>Military weapons, other than revolvers, pistols and the arms of heading 93.07</p> <ul style="list-style-type: none"> ■ Rocket launchers; flame-throwers; grenade launchers; torpedo tubes and similar projectors 	<p>Includes:</p> <ul style="list-style-type: none"> ■ rocket launchers; flame-throwers; grenade launchers; torpedo tubes; and other 'specialized military projectors'; ■ weapons that are designed to form part of vehicles that are exported separately from the vehicles. <p>Excludes:</p> <ul style="list-style-type: none"> ■ flame guns 'specialized for destroying weeds'.
Ammunition	930621 ¹	Shotgun cartridges and parts thereof	<p>Includes:</p> <ul style="list-style-type: none"> ■ shotgun cartridges; ■ some parts for shotgun cartridges. <p>Excludes:</p> <ul style="list-style-type: none"> ■ propellants; certain fuses; percussion and detonating caps; igniters; electronic detonators, including primers.ⁱⁱ
	930630 ¹	Other cartridges and parts thereof	<p>Includes:</p> <ul style="list-style-type: none"> ■ all types of cartridges for pistols and rifles; ■ some parts for pistol and rifle cartridges. <p>May include:</p> <ul style="list-style-type: none"> ■ cartridges for riveting tools and for starting engines. <p>Excludes:</p> <ul style="list-style-type: none"> ■ propellants; certain fuses; percussion and detonating caps; igniters; electronic detonators, including primers.



Item type	HS code	HS description*	Comments*
Parts and accessories	930510 930520 930521 930529	Parts and accessories of articles of headings 93.01 to 93.04 <ul style="list-style-type: none"> ■ Of revolvers or pistols ■ Of shotguns or rifles of heading 93.03 ■ Other 	<p>Includes:ⁱⁱⁱ</p> <ul style="list-style-type: none"> ■ parts and some accessories for revolvers and pistols; ■ parts and some accessories for sporting and hunting shotguns and rifles. <p>Excludes:^{iv}</p> <ul style="list-style-type: none"> ■ 'parts for general use' (e.g. rivets, screws, springs); ■ gun cases; ■ gun cameras for aircraft; ■ weapons sights; ■ other accessories covered by other headings.

Notes:

- * HS descriptions are reproduced verbatim from documents published by the World Customs Organization (WCO). Descriptions of the items included and excluded from each category also closely reflect WCO wording. The WCO is also the source for all direct quotes in the 'Notes' column of this table. See WCO (2012). The WCO's terminology for small arms often differs from the categories and definitions for small arms used in the rest of this Handbook.
- ⁱ The full title of HS 93.06 is 'Bombs, grenades, torpedoes, mines, missiles and similar munitions of war and parts thereof; cartridges and other ammunition and projectiles and parts thereof, including shot and cartridge wads' (WCO, 2012).
- ⁱⁱ The exact wording of the WCO explanatory note for these items is 'propellant powders and prepared explosives, even if put up in forms ready for incorporation in munitions (headings 36.01 and 36.02); safety fuses, detonating fuses, percussion and detonating caps, igniters and electric detonators, including primers for shells (heading 36.03) (WCO, 2012).
- ⁱⁱⁱ The WCO explanatory notes identify the following parts and accessories for, inter alia, pistols, revolvers, and the rifles and shotguns categorized in 9303.20 and 9303.30: 'Metal castings, stampings and forgings, for ... sporting and target shooting guns, etc., revolvers and pistols, e.g., barrels, breeches, locks, trigger guards, tumblers, levers, percussion hammers, cocking pieces, triggers, seats, extractors, ejectors, frames (of pistols), plates, butt plates, safety catches, cylinders (for revolvers), front and back sights, magazines ... Protective covers and protective cases, for butts, sights, barrels or breeches ... Morris tubes, etc. (small bore tubes for insertion in heavier calibre guns and rifles for practice on miniature ranges) ... Butt stocks and other wooden parts for guns, rifles or carbines and butts and plates (of wood, metal, ebonite, etc.) for revolvers and pistols ... Slings, band, piling or stacking and butt swivels and swivel bands for guns, rifles or carbines ... Silencers (sound moderators) ... Removable recoil absorbers for sporting or target shooting guns' (WCO, 2012).
- ^{iv} The exact wording of the WCO explanatory notes is: '(a) Parts of general use as defined in Note 2 to Section XV (e.g., screws, rivets and springs), of base metal (Section XV), and similar goods of plastics (Chapter 39). (b) Gun cases (heading 42.02). (c) Gun cameras for aircraft (heading 90.07). (d) Telescopic sights and similar sights for arms (heading 90.13). (e) Accessories more specifically covered by other headings of the Nomenclature, such as pull-throughs, cleaning rods and other cleaning tools for arms (headings 82.05, 96.03, etc.)' (WCO, 2012).

Source: WCO (2012)

six-digit commodity codes known collectively as the Harmonized Commodity Description and Coding System, or Harmonized System (HS). Most codes of relevance to tracking arms flows begin with '93', which is the HS chapter on 'arms and ammunition'. Table 8.4 lists the codes under which most data on transfers of small arms, light weapons, parts, ammunition, and some accessories are reported; the small arms and light weapons reported under each category; and any other items (non small arms and light weapons) that may be included in the data. The table includes the World Customs Organization's terminology and categorization for small arms, ammunition, and parts and accessories, which often differs from the categories and usage of terms in the rest of this Handbook.

Data from UN Comtrade is particularly useful for identifying and measuring trends in small arms transfers over time and across different regions, as illustrated by the data on small arms imports by countries in the Americas in Figure 8.3. The data reveals a sharp increase in arms transfers to this region, which jumped from less than USD 1 billion in 2002 to nearly USD 3 billion in 2014. By 2014, the value of transfers to the Americas was nearly twice as high as transfers to any other region.

When disaggregated by subregion, this data provides additional insights. Table 8.5 shows that the two largest importers of small arms, the United States and

Figure 8.3 Global trends in small arms imports by region, as reported to UN Comtrade (USD million), 2001–14

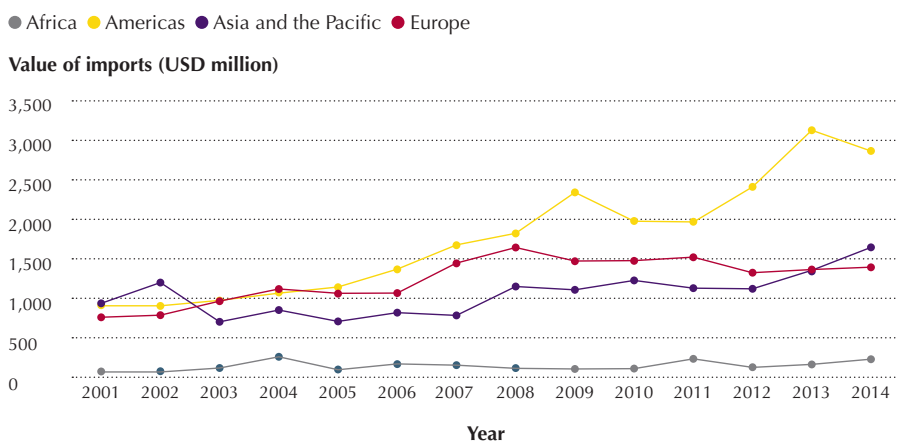

Note: All values are expressed in constant 2014 US dollars.

Sources: NISAT (n.d.) via Holtom and Pavesi (2017, p. 25)

Table 8.5 Value of small arms supplied to the Americas, by subregion, as reported to UN Comtrade (USD million), 2001–14

Subregion	Value of small arms imports (USD million)			
	2001	2014	Average, 2001–14	Change from 2001 to 2014
Caribbean	14	16	17	2
Central America	34	107	68	73
Northern America	759	2,580	1,538	1,821
South America	114	172	140	57

Note: All values are expressed in constant 2014 US dollars. Due to rounding, individual values may not add up.
Sources: NISAT (n.d.) via Holtom and Pavesi (2017, p. 29)

Canada, account for most—but not all—of this increase. Imports of small arms in Central America rose by more than 300 per cent from 2001 to 2014. This increase may be of interest to journalists and researchers covering security issues in Central America, including the sharp rise in drug-related violence during this period. Data from UN Comtrade is a good starting point for investigating possible links between drug-related insecurity and the procurement of small arms by state and non-state actors in the region.

UN Comtrade is less useful for tracking individual transfers, and exports of certain categories of items. The data is aggregated by year and, unless there was only one transfer to a given country during the year under review, determining the quantity or value of a particular transfer is not possible. Since the data contains no information about the manufacturer, model, or calibre of transferred weapons, UN Comtrade is also not particularly useful for corroborating claims in other sources about transferred weapons.

Data aggregation also precludes meaningful analysis of most light weapons transfers. Exports of light weapons and their parts, accessories, and ammunition are reported with data on non small arms and light weapons items, such as artillery guns, air-delivered weapons, and torpedo tubes. Similarly, data on weapon sights is combined with data on telescopes and periscopes (WCO, 2017, p. 5), rendering this data largely useless for tracking transfers of optics for small arms and light weapons. Data on transfers of military firearms (HS code 930190) is also mixed with unrelated items, and determining exactly which items is difficult

because 930190 is a catch-all code, meaning that, in addition to military firearms, this code contains data on any transfers of items that do not clearly fit into one of the other four subcategories of ‘military weapons’.

More detailed customs data is available for certain countries. A good example is data on exports of ‘military firearms’ published by the United States Census Bureau. As noted above, data on military firearms available from UN Comtrade also contains data on other items, which significantly reduces the usefulness of this data for tracking small arms transfers. The data published by the Census Bureau, which is from the same source as the data provided by the United States to UN Comtrade, partially addresses this problem by disaggregating the data into four subcategories: military rifles, military shotguns, machine guns, and other ‘military weapons’.

As shown in Table 8.6, machine guns account for most of the items reported under HS code 930190, followed by military rifles. Military shotguns only comprise a small percentage of these items. The disaggregated data also reveals that transfers of military firearms comprise approximately 94 per cent of the all transfers

Table 8.6 Exports of military firearms and other items from the United States as recorded under HS code 930190, 2006–15

Commodity (HST code)*	Value		Quantity	
	Total (USD)	Per cent	Total	Per cent
Military rifles (HS code 9301903000)	576,397,770	33	641,887	37
Military shotguns (HS code 9301906000)	41,161,670	2	242,923	14
Machine guns (HS code 9301909030)	633,144,241	37	734,060	43
Military weapons, exc Arms Of Heading 9307, Nesoi (no) (HS code 9301909090)	477,987,227	28	102,451	6
Total (USD)	1,728,690,908		1,721,321	

Note: * The code used here is the ten-digit Harmonized Tariff Schedule (HTS) of the United States. In accordance with Article 3 of the HS Convention, individual governments can add subdivisions to the HS code for statistical reasons. The first six digits of any national tariff system will always be the relevant HS codes.

Source: US Census Bureau (n.d.)

Table 8.7 Data on weapon sights imported by Chile, Peru, and Uruguay, 2007–10

Importing Country	Importer	Country of Purchase	Country of Origin	Transport Method	Quantity	Brand	Description
Peru	Armaq sociedad anonima	*	China	Aerea	3	Shilba	Mira, shilba, 3-10x44 illuminator 152306 - para carabinas de aire comprimido y deporte
Uruguay	Pinor sociedad anonima	China	China	Vapor	16	Not specified	*
Chile	Immaxal S.A	Uruguay	Uruguay	Aereo	20	Shilba	Con montura,para armas
Chile	Immaxal S.A	Uruguay	Uruguay	Aereo	20	Shilba	Pararifle, de uso en caza
Uruguay	Pinor sociedad anonima	Montevideo free zone	China	Vapor	10	Not specified	*
Peru	Armaq sociedad anonima	*	China	Maritimo	6	Shilba/para carabinas de aire comprimido	Mira, shilba, iluminator 3-10 x 44 para carabinas de aire comprimido - 152306
Uruguay	Arcocity S.A	United states	Philippines	Vapor	19	Not specified	*
Chile	Immaxal S.A	Uruguay	Uruguay	Aereo	20	Shilba	Con montura,para armas
Chile	Immaxal S.A	Uruguay	Uruguay	Aereo	10	Shilba	Vision 6-24x50
Uruguay	Arcocity S.A	United states	Philippines	Avion	18	Not specified	*
Peru	Armaq sociedad anonima	*	China	Aerea	8	Shilba	Mira shilba 10x50 152307 uso comercial bultos mira ``shilba`` 2.5-10X50ir d30 il.Mag. S/cp
Peru	Armaq sociedad anonima	*	China	Maritimo	18	Shilba	Mira, shilba, 152306 para carabinas de aire y/o deporte 3-10 x 44a illuminator

Note: The information in this table is taken verbatim from the source to reflect the original data.

Source: Datamyne (n.d.)

reported by the United States under HS code 930190 in number, but only 72 per cent of the value. The rest of the exports were reported under the ambiguous subcategory of 'Military weapons, Exc Arms Of Heading 9307, Nesoi (no).' Whether US customs data is representative of the data submitted by other states is unknown. Regardless, this case underscores the need to fully understand commodity categorization schemes, and to treat data in catch-all categories with an abundance of caution.

Even more detailed customs data is available for a fee from companies that specialize in obtaining trade data directly from customs agencies. While less voluminous than data reported to UN Comtrade, the records collected by these companies often include key information generally not available elsewhere, such as the make and model of the imported items, the importer, end user, and transport method. An example of data from the US-based company Datamyne is provided in Table 8.7.

UN Comtrade and other publicly-available customs data is less useful for tracking transfers between countries with less transparent governments, which include several major arms exporting and importing states.¹⁹⁴ These governments often withhold data on transfers of key items, including military firearms, pistols, and revolvers (Dreyfus, Marsh, and Schroeder, 2009, p. 10).

One strategy for tracking arms transfers from non-transparent countries is analysis of mirror data, which, as noted above, is data published by an importing or exporting country's trade partner. Data on African imports of small arms from China illustrates the utility of mirror data in filling gaps in export data. Figure 8.4 shows data submitted by China on exports of light weapons (930120), military firearms (930190), small calibre ammunition (930630), and pistols and revolvers (930200) to four African countries in conflict zones (Cameroon, Niger, Nigeria, and Sudan). China does not report on transfers of these items to UN Comtrade and thus the query yielded no data. However, mirror data on imports of weapons from China submitted by these countries shows transfers worth more than USD 8 million from 2010 to 2014. By systematically searching mirror data in UN Comtrade, it is often possible to piece together information on some transfers to and from less transparent states. Rarely does this data provide a complete accounting of transfers from large exporters, however.

¹⁹⁴ Major small arms exporters are ranked by level of transparency in Small Arms Survey's Transparency Barometer (Small Arms Survey, n.d.b). See also the Small Arms Survey's *Trade Update* series.

Figure 8.4 Data on small arms exports reported by China (top) and by four trade partners in Africa (bottom), 2010–14

UN Comtrade Database Extract data Data Availability Metadata Reference Knowledge base API portal

1. Type of product & Frequency

Type of product: Goods Services Frequency: Annual Monthly

2. Classification

HS: As reported 92 96 02 07 12 17 SITC: As reported Rev. 1 Rev. 2 Rev. 3 Rev. 4 BEC: BEC

3. Select desired data

Periods (year): 2010 2011 2012 2013 2014
ALL or a valid period. Up to 5 may be selected.

Reporters: China
ALL or a valid reporter. Up to 5 may be selected. ALL may only be used if a partner is selected.

Partners: Cameroon Niger Nigeria Sudan
World, ALL, or a valid reporter. Up to 5 may be selected. ALL may only be used if a reporter is selected.

Trade flows: Import
ALL or select multiple trade flows.

HS (as reported) commodity codes

930120 - Military weapons; rocket launchers, flame-throwers, grenade launchers, torpedo tubes and similar projectors
 930190 - Military weapons; other than revolvers, pistols, and arms of heading 9307, n.e.c. in heading 9301
 930630 - Ammunition; cartridges and parts thereof n.e.s. in heading no. 9306 930200 - Revolvers and pistols; other than those of heading no. 9303 or 9304
ALL, Total, AG[X] or a valid code. Up to 20 may be selected. If you know the code number, e.g. 01 - Live animals, type 01. To search by description type a word, e.g. rice.

4. See the results

[Preview >](#) [Download CSV](#)

Issues opening CSV in Excel? See this Microsoft how-to.

5. Preview (0 records)

Show 25 entries

Period	Trade Flow	Reporter	Partner	Commodity Code	Trade Value (US\$)	Netweight (kg)	Qty Unit	Qty	Flag
No data available in table									

Showing 0 to 0 of 0 entries [First](#) [Previous](#) [Next](#) [Last](#)

Estimated quantity/netweight shown in italics.
 Flag refers to quantity/netweight estimation:
 0 = no estimation, 2 = quantity, 4 = netweight, 6 = both quantity and netweight

View API call | API documentation

Period	Trade Flow	Reporter	Partner	Commodity Code	Trade Value (US\$)	Netweight (kg)	Qty Unit	Qty	Flag
2012	Import	Cameroon	China	930120	\$927	889	No Quantity	0	0
2012	Import	Cameroon	China	930200	\$195,932	193	Number of items	506	2
2012	Import	Niger	China	930120	\$887,456	14,000	No Quantity	0	0
2010	Import	Niger	China	930190	\$564	8	No Quantity	0	0
2011	Import	Niger	China	930190	\$318	2	No Quantity	0	0
2012	Import	Niger	China	930190	\$395,652	4,744	No Quantity	0	0
2014	Import	Niger	China	930190	\$2,647,363	8,728	No Quantity	0	0
2010	Import	Niger	China	930200	\$907	7	Number of items	3	2
2012	Import	Niger	China	930200	\$1,175	2	Number of items	3	2
2013	Import	Niger	China	930200	\$203	1	Number of items	1	2
2014	Import	Niger	China	930200	\$350	2	Number of items	1	2
2011	Import	Nigeria	China	930630	\$7,915	4,801	Weight in kilograms	4,801	0
2013	Import	Nigeria	China	930630	\$1,136	354	Weight in kilograms	354	0
2012	Import	Sudan	China	930190	\$3,792,195	262,700	No Quantity	0	0
2012	Import	Sudan	China	930200	\$513,364	15,000	Number of items	1,268	2
2013	Import	Cameroon	China	930200	\$1,216	2	Number of items	3	2

Showing 1 to 16 of 16 entries [First](#) [Previous](#) [Next](#) [Last](#)

Estimated quantity/netweight shown in italics.
 Flag refers to quantity/netweight estimation:
 0 = no estimation, 2 = quantity, 4 = netweight, 6 = both quantity and netweight

Modify selection [Download CSV](#)

Source: UNSD (n.d.c)

Table 8.8 Strengths and limitations of UN Comtrade

Best for:	Less useful for:	Caveats:
<ul style="list-style-type: none"> ■ Monitoring and measuring trends in small arms transfers over time and across regions. ■ Identifying trade partners of less transparent countries ■ Researching transfers of: (1) pistols and revolvers; (2) sporting and hunting rifles and shotguns; (3) small calibre ammunition; and (4) parts for small arms. 	<ul style="list-style-type: none"> ■ Tracking individual transfers. ■ Researching: (1) most light weapons; (2) accessories for small arms and light weapons; (3) light weapons ammunition; and (4) parts for light weapons and light weapons ammunition. ■ Confirming reports of arms transfers in other sources. 	<ul style="list-style-type: none"> ■ Many commodity categories include data on unrelated items (see Table 8.4). ■ There is no central mechanism for ensuring accuracy and completeness. ■ Some governments do not report on transfers of certain items, such as military firearms (930190). ■ Some types of transfers, such as military-to-military arms exports, are not always captured in customs data. ■ Some weapons are not clearly, consistently, or explicitly categorized. ■ Errors found by researchers highlight the need to confirm and corroborate data.*

Note: * See Dreyfus, Marsh, and Schroeder (2009, p. 27).

Even governments that submit data on all commodity categories do not necessarily report on every arms transfer. Government-to-government transfers sometimes go unreported, including when exported weapons are shipped directly from military installations and do not pass through ports of exit administered by customs agencies. Also noteworthy is the absence of information on intermediary recipients and end users of transferred arms, which is critical for tracking weapons throughout the chain of custody.

Finally, since the UN Statistics Commission cannot verify the accuracy of the data that it receives, the onus is on individual governments to ensure that their data is accurate. ‘The WCO makes efforts to ensure uniform application of the [Harmonized System],’ observed one WCO representative. ‘But it is up to [individual governments] to ensure correct classification and thus reporting of trade data.’¹⁹⁵ Thus, the completeness and accuracy of the data varies, and errors discovered by researchers highlight the need to verify and corroborate the data, when possible.¹⁹⁶ Table 8.8 summarizes the primary uses for—and limitations of—UN Comtrade.

¹⁹⁵ Email correspondence with WCO official, 19 September 2016.

¹⁹⁶ See Dreyfus, Marsh, and Schroeder (2009, p. 27).

Analysing the UN Register of Conventional Arms (UNROCA)

The UN Register of Conventional Arms, or 'UN Register', is a UN-administered reporting mechanism for international transfers of major conventional weapon systems and, to a lesser extent, small arms and light weapons. All UN member states are requested to submit data annually on exports and imports of seven categories of weapon systems:

- battle tanks (Category I);
- armoured combat vehicles (Category II);
- large-calibre artillery systems (Category III);
- combat aircraft (Category IVa), including unmanned combat aerial vehicles (Category IVb);
- attack helicopters (Category V);
- warships (Category VI); and
- missiles or missile launchers (Category VII),¹⁹⁷ including man-portable air defence systems (MANPADS) (Category VIIb).

The lists of items reported under two of the seven main categories include light weapons. Category III includes mortar systems with calibres of 75 mm or larger, which are frequently encountered in seized arms caches and in the arsenals of armed groups.¹⁹⁸ Category III also includes crew-portable and towed multiple-barrel rocket launchers (MBRLs), some of which are also considered light weapons. The Iranian defence industry, for example, produces a single tube rocket launcher that weighs just 23 kg (DIO, n.d.). While most other multiple-launch rocket systems exceed size and weight limits for 'light weapons', armed groups often fire their ammunition from improvised launchers that are man- or crew-portable. Groups in Iraq and elsewhere have built a wide array of launchers for these rockets, which vary significantly in terms of size and sophistication (Schroeder, 2014b).

The highest-profile light weapons reported in the seven main categories are MANPADS, which many governments regard as particularly sensitive because of the potential threat they pose to commercial aviation. This sensitivity is evident

197 With exception of MANPADS (which has its own subcategory), Category VII only includes missiles, rockets, and launchers with a range of at least 25 km, which excludes most if not all crew-portable anti-tank guided missiles. See UNODA (2007, p. 20).

198 Category III also includes mortar systems that are generally not considered light weapons, including systems with calibres that are greater than 120 mm.

Figure 8.5 Excerpts from the Russian Federation's submission to the UN Register regarding conventional arms exported in 2009 (top) and 2012 (bottom)

A		B	C	D	E	Remarks	
Category (I-VII)		Final importer State(s)	Number of Items	State of origin (if not exporter)	Intermediate location (if any)	Description of Item	Comments on transfer
VII. Missile launchers and missiles	(a)	Algeria	306				
		India	282				
		Serbia	8				
		Viet Nam	16				
	(b)	Egypt	98			MANPADS	
		Venezuela (Bolivarian Republic of)	1 800			MANPADS	
VII. (b) Man-portable air defence systems	Venezuela (Bolivarian Republic of)	2 400			2 000 man-portable air defence missiles and 400 launchers		
	Brazil	26			18 man-portable air defence missiles and 8 launchers		
	Azerbaijan	1 200			1 000 man-portable air defence missiles and 200 launchers		

Sources: Top: UNGA (2010, p. 24); bottom: UNGA (2013b, p. 28)

in the special status of MANPADS in the UN Register; it is one of only two groups of weapons that have their own dedicated subcategories. Since the subcategory for MANPADS was first used in 2004, governments have reported on the transfer of thousands of the missile systems, making the UN Register one of the best sources of data on the proliferation of MANPADS.

Among the most notable MANPADS transfers recorded in the UN Register are exports of advanced Russian Igla-S systems to Venezuela in 2009 and 2012 (see Figure 8.5). Russian export data reveals that the Venezuelan military has received at least 4,200 MANPADS missiles and launchers, making it the largest documented importer of MANPADS in more than a decade.¹⁹⁹ Journalists reporting on the potential threat posed by these missiles frequently use data from the UN Register.²⁰⁰ These articles highlight the UN Register's value as a source for data on potentially problematic accumulation of sensitive weapons in unstable regions.

199 See also SIPRI (n.d.); UNROCA (n.d.b).

200 See Forero (2010); Gupta (2017).

Figure 8.6 Excerpt from the Czech Republic's submission to the UN Register regarding small arms exported in 2010

A	B	C	D	E	Remarks	
					Description of Item	Comments on transfer
Small arms						
1. Revolvers and self-loading pistols	Australia	10			Tokarev 1933	
		3			GP 35	
	Bangladesh	5 003			CZ 75	
	Philippines	1 500			CZ 75	
	Indonesia	3			CZ 75	
	Iraq	6 000			CZ 75	
	Jordan	1			CZ 75	
	Canada	390			TT cal 7,62	
	Kenya	31			CZ 75	
	Lithuania	25			CZ 75, 2075,83	
	Luxembourg	2			Tokarev 1933	
	Mexico	3 695			CZ 75	
	Namibia	508			CZ 75	

Source: UNGA (2011, p. 88)

States are also invited (but not required) to submit information on: (1) transfers of small arms and light weapons;²⁰¹ (2) national holdings of weapons; and (3) procurement of weapons through domestic production.²⁰² The first data on small arms transfers received by the UN Register dates back to the 1990s, but few governments reported on small arms until 2006. Since then, the UN Register has received records on tens of thousands of imports and exports of small arms, some of which are quite detailed. As this archive grows, it is increasingly useful for researching small arms flows.

Submissions to the UN Register vary significantly in terms of scope, detail, and completeness. Some states only submit the bare minimum of data required to meet UN reporting requirements while others provide detailed lists of all transfers of small arms and light weapons, identifying the make, model, calibre, origin state, and intermediate states for each transferred weapon.

²⁰¹ In 2016, the UN adopted a '7+1 formula' that elevated the status of reporting on small arms and light weapons above its previous categorization as 'background information' but stopped short of creating an eighth main reporting category. It is not clear what, if any, impact this change will have on reporting on small arms and light weapons transfers. See Holtom and Pavesi (2017, p. 57); UNGA (2016a, para. 61(a)–(h), para. 75; 2016b).

²⁰² See UNGA (2006a, p. 1).

Figure 8.6 is an excerpt from the Czech Republic’s submission on exports of small arms and light weapons in 2010, which includes a reference to 6,000 CZ 75 pistols transferred to Iraq in 2010. This type of data is extremely useful for studying arms flows to conflict zones and for narrowing down possible sources of weapons recovered from unauthorized end users.

Like all of the data sources profiled in this chapter, the UN Register has limitations, which affect the completeness, comparability, and verifiability of the data (see

Table 8.9 Strengths and limitations of the UN Register of Conventional Arms

Best for:	Less useful for:	Caveats:
<ul style="list-style-type: none"> ■ Researching arms exports from certain countries, including many European countries. ■ Tracking exports, re-exports,ⁱ and imports. ■ Researching transfers of: (1) military firearms; (2) pistols and revolvers; and (3) light weapons, especially MANPADS. 	<ul style="list-style-type: none"> ■ Tracking transfers from major non-European exporters to much of Asia, Africa, Latin America, and the Middle East.ⁱⁱ ■ Tracking transfers of civilian firearms.ⁱⁱⁱ ■ Researching: (1) small arms ammunition; (2) ammunition for most light weapons; (3) parts for small arms and light weapons, including kits for assembling complete weapons;^{iv} (4) accessories for small arms and light weapons; (5) missiles and rockets with a range of less than 25 kilometres;^v and (6) missiles for MANPADS delivered separately from launchers.^{vi} 	<ul style="list-style-type: none"> ■ Some states report on arms transfers to governments and civilians while others only report on transfers to other governments.^{vii} ■ Many states do not indicate whether they are reporting on authorizations (licences issued) or deliveries. ■ Some states report selectively, excluding data on certain transfers.^{viii} ■ Researchers have discovered significant errors.^{viii}

Notes:

- i UN reporting guidelines explicitly advise states to report on transfers, including transfers of ‘second-hand equipment’ (UNODA, 2007, para. 18).
- ii See UNROCA (n.d.c) for reporting rates by region.
- iii While some states report on transfers of civilian weapons, UN guidelines only recommend that states report on transfers of weapons that are ‘made or modified to military specification and intended for military use’ (UNGA, 2003, para. 113(e)). Similarly, states are only expected to report on transfers involving ‘States Members of the United Nations’ (UNGA, 2006b, para. 126(a)).
- iv UNODA (2007, para. 15).
- v Few, if any, missiles or rockets categorized as ‘light weapons’ have a range of 25 km or more.
- vi See UNODA (2007, para. 8).
- vii See Holtom (2008, p.35).
- viii See Wezeman and Wezeman (2015).

Table 8.9). Many countries, including major producers, exporters, and importers in conflict zones, do not report on most small arms and light weapons transfers. These countries include several identified by the Small Arms Survey as top small arms exporters, including Belgium, Brazil, China, Israel, and Russia. Compounding this problem is a precipitous decline in reporting more generally. In 2015, the UN Register received 54 submissions as compared to 126 in 2001 (UNGA, 2016a, para. 17; Holtom, Pavesi, and Rigual, 2014, p. 133). If reporting rates do not improve, the UN Register will become increasingly irrelevant as a data source for tracking arms flows.

Researchers should also be aware of divergent reporting practices by participating governments. Some submissions are based on licensing data while others reflect actual deliveries.²⁰³ The submission of licensing data without indicating that the data is based on licences and not actual transfers is problematic because not all licences lead to transfers, or to the transfer of all of the items specified in the licences. Similarly, some states report on exports to civilians while others only include data on government-to-government transfers.²⁰⁴ Differences in how states categorize transferred weapons also complicate analysis of UN data. This problem is exacerbated by ambiguous categorization on the UN Register's reporting form. One state may categorize an automatic AK-pattern rifle as a 'light machine gun' while another may report it under 'rifles and carbines', 'sub-machine guns', or 'assault rifles'.²⁰⁵

These incongruities often preclude the use of mirror data to verify information on specific transfers. Data submitted by exporting governments often does not match data on the same transfer submitted by the importing government, and often one of the governments does not report on the transfer at all. An analysis of 77 submissions on light weapons transfers from 2003–06 by the Stockholm International Peace Research Institute (SIPRI) yielded only ten exact matches (Holtom, 2008,

203 The UN's *Guidelines for Reporting on International Transfers* explicitly instructs participating governments to report on 'only those transfers which they consider to have been effected' during the previous calendar year (UNODA, 2007, para. 5). More than half of the governments surveyed by SIPRI in 2008 indicated that their UN Register submissions on exports were based on licensing data (Holtom, 2008, p. 26).

204 In its 2003 report, the Group of Government Experts on the continuing operation and further development of the United Nations Register of Conventional Arms limited its recommendation regarding submission of data on transfers of small arms and light weapons to 'weapons made or modified to military specification and intended for military use' (UNGA, 2003, para. 113 (e)).

205 UNGA (2016a, p. 37).

pp. 31–32). Thus, researchers often have to use other sources to verify data found in the UN Register.

Finally, the UN Register’s database has several significant functional limitations. It has no keyword search function and is currently incapable of retrieving data on specific transfers by year, weapon category, region, or report type (that is, import or export). To gather data on transfers of a particular type of weapon, researchers must download each country’s annual submission individually and manually compile relevant data points from each submission. These shortcomings significantly limit the database’s utility as a research tool. Fortunately, much of the data in the UN Register is accessible via user-friendly databases maintained by SIPRI and the Norwegian Initiative on Small Arms Transfers (NISAT) (SIPRI, n.d.; NISAT, n.d.).

Analysing social media

Social media outlets, including YouTube, Facebook, Flickr, and Twitter, are increasingly powerful tools for researching arms flows. These platforms are the largest repositories of open-source data in the world. This data includes millions of photographs, videos, and documents, including numerous images of exported small arms and light weapons. Unlike government reporting (most of which is annual), images available on social media are often posted shortly after they are generated, sometimes providing near real-time updates on transfers and holdings.

Images posted on social media also shed light on transfers to and from governments that do not publish data on their arms imports and exports. From footage of military parades to selfies taken by soldiers holding imported rifles, social media is awash with images of transferred weapons, the importance of which increases as the number of governments who regularly provide data to the UN Register shrinks.

These images are also useful for determining—or confirming—the make and model of specific weapons. It was a YouTube user, not a government report, that revealed the model of Russian MANPADS exported to Venezuela in the 2000s (Herron, Marsh, and Schroeder, 2011, p. 22; see Image 8.1).

Social media has also facilitated a notable expansion in the capacity to analyse the steady stream of images of transferred weapons posted online. By pooling their expertise via loosely organized networks on Facebook and Twitter, analysts and hobbyists with different backgrounds are able to instantaneously share infor-

Image 8.1 Screenshots from video of Venezuelan military parade, 2009



Source: Soto (2009)

Table 8.10 Strengths and limitations of social media

Best for:	Less useful for:	Caveats:
<ul style="list-style-type: none"> ■ Identifying transferred weapons, accessories, and ammunition in combat zones and in some countries with non-transparent governments. ■ Corroborating claims about the make and model of some transferred weapons. 	<ul style="list-style-type: none"> ■ Systematically tracking and measuring arms flows. 	<ul style="list-style-type: none"> ■ Erroneous identification of weapons is common. ■ Postings are ad hoc and therefore coverage of transferred weapons is incomplete. ■ Widely available search engines are currently incapable of identifying all images of a particular weapon or from a particular country or region.

mation and, in some cases, accurately identify different models of arms and ammunition, including new and obscure items.

Social media's strengths are also its weaknesses, however (see Table 8.10). The decentralized nature of social media means that anyone with a smartphone can anonymously upload images and distribute them to millions of people around the world. Unlike traditional media, there is no vetting and little accountability, and dissemination (through retweets, for example) is instant and effortless. Consequently, information—including erroneous information—spreads rapidly, making social media an attractive tool for distributing propaganda and advancing political agendas.

There are several tools for assessing the accuracy of claims about weapons in social media posts, the authenticity of their contents, and the time and location of the events depicted in the posts. Among the most important tools are the weapons identification techniques included in this Handbook (see Chapters 3–7). Other tools include digital forensic techniques, time-stamping, and geolocation. None of these techniques are foolproof, however, and information from social media posts should be corroborated with data from other sources and verified by weapons specialists, whenever possible.

Decentralization also means that it is difficult to systematically search, collate, and store data on arms transfers posted on social media. No single search engine generates a complete set of hits from all social media posts, and most images of weapons are not identified and tagged. Advances in image recognition technology are yielding software capable of distinguishing weapons from other items, but these

technologies are not yet widely available. Until advanced image recognition technology becomes more available, many—perhaps most—images of imported weapons posted on social media will go unnoticed.

A related problem is that most social media posts on imported and exported weapons are ad hoc and, consequently, coverage of arms transfers is almost always incomplete. While voluminous in number, these images only document a small percentage of transferred weapons. Furthermore, the vast majority of photos and videos of weapons shared on social media were taken for purposes other than documenting arms flows. As a result, many do not include the weapon's markings or distinctive physical characteristics, which reduces their analytical value. As described in detail in previous chapters, markings can reveal much about illicit weapons, including their make and model, country and date of manufacture, and even uniquely identifying information such as serial or batch number. This information provides important clues about the item's history, including, in some cases, its chain of custody.

Analysing tenders and contract award notices

Documents on the procurement of weapons and ammunition by government entities sometimes contain detailed information about exports and imports. These documents take many forms, including budget documentation, contract award notices, and tender notifications. An example of a contract award notice is provided in Figure 8.7.

The notice concerns the planned procurement by the US military of 40 mm grenade launchers on behalf of the government of Iraq. The contract for the launchers was awarded through the US Foreign Military Sales programme, the primary mechanism for authorizing and administering government-to-government arms sales.²⁰⁶ The notice includes the value of the contract, the company to which the contract was awarded, the location where the launchers will be manufactured, and the scheduled completion date—significantly more information than is included in most arms transfer reports. The notice also includes a reference number for the contract, which can be used to request more information (US DoD, 2016), such as the model and precise calibre of the launchers. Government agencies in some other countries publish similar documents online.²⁰⁷

²⁰⁶ In addition, the Defense Security Cooperation Agency (DSCA, n.d.) provides more information on the US Foreign Military Sales programme.

²⁰⁷ See, for example, EU (n.d.); Philippine DND (2013); Indian National Informatics Centre (2013).

Contract award notices and other procurement documentation can be valuable sources of data on weapons procured through government-to-government arms export programmes. Contracts are sometimes cancelled or revised, however, rendering data in award notices obsolete. Furthermore, such notices often do not provide a full accounting of potential exports since they may not reflect contracts issued by agencies or through programmes that are exempt from reporting requirements. Some agencies do not issue notices for contracts worth less than a certain amount. For example, the US Department of Defense only issues award notices for contracts valued at USD 7 million or more (US DoD, n.d.). Given the comparatively low unit cost of most small arms, contracts that fall below reporting thresholds may account for a large quantity of these weapons in some countries.

Figure 8.7 US Defense Department contract award notice regarding the procurement of 40 mm grenade launchers for Iraq, 2016

The screenshot shows the US Department of Defense website's 'Contracts for June 7, 2016' page. The main heading is 'Contracts for June 7, 2016' under the 'CONTRACTS' and 'ARMY' categories. A red box highlights the following text:

AMTEC Corp., Janesville, Wisconsin, was awarded an \$84,546,877 firm-fixed-price, foreign military sales contract (Iraq) for 40mm grenade systems. One bid was solicited with one received. Work will be performed in Janesville, Wisconsin, with an estimated completion date of Sept. 30, 2018. Fiscal 2014, 2015 and 2016 other procurement (Army) funds in the amount of \$84,546,877 were obligated at the time of the award. Army Contracting Command, Rock Island Arsenal, Illinois, is the contracting activity (W52P1J-16-C-0049).

An arrow points from this red box to a larger text box below, which contains the same text as the highlighted section.

AMTEC Corp., Janesville, Wisconsin, was awarded an \$84,546,877 firm-fixed-price, foreign military sales contract (Iraq) for 40mm grenade systems. One bid was solicited with one received. Work will be performed in Janesville, Wisconsin, with an estimated completion date of Sept. 30, 2018. Fiscal 2014, 2015 and 2016 other procurement (Army) funds in the amount of \$84,546,877 were obligated at the time of the award. Army Contracting Command, Rock Island Arsenal, Illinois, is the contracting activity (W52P1J-16-C-0049).

Source: US DoD (2016)

Box 8.1 Tips for researchers: analysing data on authorized arms flows

- **Determine which items are included in the data.** Some sources only include data on government-to-government transfers of fully-assembled weapons while other sources include data on transfers of civilian firearms; parts, accessories, and ammunition; and/or technical information. Determining which items are included helps to identify any data gaps, and enables you to convey to your readers which items are covered—and which are not covered—in the data.
- **Determine whether the data reflects potential exports or actual exports.** Reports on ‘arms exports’ published by governments sometimes only consist of data on potential exports, such as export licences issued. Since not all licences result in deliveries, or in deliveries in the quantities specified in the licence, you should attempt to determine whether the data reflects potential or actual exports. If these attempts prove unsuccessful, you should explain to the reader that it is not clear whether the weapons have been delivered to the end user.
- **Identify any commodity categories or column headings that are vague, misleading, or over-aggregated.** Of particular concern are the following data and categorization practices:
 - (1) Inclusion of components, technical data, accessories, and other items in commodity categories that appear to only include complete weapons (for example, ‘rifles’, ‘firearms’, etc.).
 - (2) Use of ‘catch-all’ commodity categories that combine data on transfers of clearly identified items with transfers of items that do not clearly fit into other commodity categories. These categories can become dumping grounds for data on unusual items and on shipments by exporters who do not fully understand the categorization scheme.
 - (3) Use of misleading or unclear data on quantities. It is sometimes unclear whether data in the ‘quantity’ column refers only to complete (assembled) weapons or a combination of complete weapons, components, and/or accessories. In these cases, assuming that the data refers to complete weapons may result in significant overestimates.
- **Determine whether the data includes all arms transfers from a particular country or agency.** Some sources only include data on certain categories or types of arms transfers, such as government-to-government arms sales. Transfers that are commonly omitted from national reports and other government data sources include: (1) exports and imports of firearms and ammunition to civilians; (2) classified exports; (3) transfers that fall below reporting thresholds; (4) transfers of parts, components, and technical data in furtherance of licensed production arrangements; and (5) weapons, ammunition, and related items that are provided as part of foreign aid and training programmes.
- **Verify the data and interpretations of the data.** As noted above, reports on arms transfers often do not define key terms or column headings. These reports also sometimes include ambiguous or poorly defined commodity categories, and occasionally contain errors. Providing the reporting agency with the opportunity to explain its methodology, clarify terms and definitions, and confirm the accuracy of key data points helps to minimize errors and misinterpretations, and to ensure that analysis of the data is sufficiently nuanced and includes the appropriate caveats. You should cross-check data from the above-mentioned sources with other sources, and attempt to resolve any discrepancies with the assistance of officials from reporting agencies. Any unresolved discrepancies should be flagged for readers.

Conclusion

Tracking arms flows is a challenging but critically important endeavour that, until recently, has been constrained by the centralization of data and ponderous reporting practices. Recent advances in computing power, connectivity, and smartphones have resulted in exponential increases in the quantity of information that is publicly available, including information on weapons in (and from) some

of the least transparent countries in the world. The simultaneous expansion of field research complements the voluminous but often unverifiable imagery available on social media. When combined with records from UN databases and other legacy sources, this rapidly growing pool of data has the potential to dramatically improve our understanding of how, where, and to whom small arms are acquired and used.

— **Author**

Matt Schroeder

CHAPTER 9

Analysing Arms Flows: Illicit weapons

Introduction

Tracking illicit arms flows is often significantly more difficult than tracking the authorized trade (see Chapter 8). There are no datasets comparable to UN Comtrade and the UN Register of Conventional Arms (UNROCA) for illicit weapons, and the data that is available on illicit arm flows is incomplete, often ambiguous, and frequently limited to anecdotal accounts of individual illicit transfers. These accounts are few and far between, and only rarely are they sufficient in quantity or detail to draw any conclusions about trafficking in a particular region.

Nonetheless, careful analysis of available data can reveal much about the types, origins, and recipients of illicit weapons and ammunition, and the methods and routes used by traffickers to smuggle these items across borders. This chapter looks at several prominent sources of data on illicit small arms, including data on weapons seized at border crossings (border seizures) and local seizures (weapons recovered at crime scenes and from arms caches). It also examines images and information available on social media.

For the purposes of this chapter, ‘border seizures’ are shipments of weapons and other items detained by authorities of the importing or exporting state at or near international borders. ‘Local seizures’ are incidents other than border seizures in which authorities take weapons into custody. It should be noted that the term ‘seizure’ can be a bit misleading in that some of these items are only temporarily detained or are voluntarily surrendered.

Analysing data on border seizures

Data on weapons and related items interdicted at or near border crossings is an important source of information on illicit arms flows. Depending on the level of detail and time frame, border seizure data can reveal the types of frequently trafficked weapons, the countries from which these weapons are trafficked, and the methods and routes used by traffickers. Data that covers seizures over several years may also reveal changes in trafficking patterns.

Table 9.1 shows records of border seizures compiled by US Customs and Border Protection (CBP) that were obtained under the US Freedom of Information Act. The records identify:

- The type and quantity of seized items and, in many cases, the make, model, and/or calibre.

- The date that the items were seized.
- The destination of the seized shipment.

The records also include information about the legal and physical status of the seizure and the statutory authority under which the weapons were seized, which is often as important as the information about the seized weapons themselves. Arms shipments are detained by customs agents for various reasons, ranging from minor paperwork issues to strong evidence of arms trafficking. Information about statutory and regulatory violations linked to the seized items and their administrative status provides important clues regarding the nature of the seizure. For example, CBP officials told the Small Arms Survey that weapons ‘transfer[red] to UFPD’ were probably seized for substantive reasons (including trafficking) while items that were ‘remitted’ were probably detained as a result of technical violations of applicable legislation rather than deliberate arms trafficking.²⁰⁸

These records highlight the importance of developing a clear working definition of ‘illicit’ that reflects the scope and purpose of the research. In some of the cases documented in these records, the shipper may have violated export laws with no nefarious intent. Examples include unlicensed shipments of firearms components by a licensed company to a legitimate foreign manufacturer of firearms. In the United States (and many other countries), shipments would be illegal since they violate national licensing requirements. But the impact on peace and security of such shipments is minimal compared to that of shipments of semi-automatic pistols and rifles to Mexican drug cartels, for example. As such, some recorded cases may not be relevant to a particular story or report. Whether it is possible to exclude specific types of cases depends on the data. Regardless, it is important for researchers to develop precise definitions for ‘illicit’ and other key terms, and to clearly present these definitions to their readers.

Analysing data on local seizures

Local seizures are another rich source of data on illicit small arms. Data on local seizures takes many forms and is generated by both non-governmental and governmental sources. In some cases, the seizure is summarized in detailed narratives that include photos of the seized weapons and maps of their location (see Image 9.1).

²⁰⁸ Phone interview with CBP official, July 2012.

Table 9.1 Small arms taken into custody by US CBP, 2009–11

Nvtry Qty Amt	Prptry Typ Txt	Prptry Dsc Txt	Going To	Lgl Stus Txt	Plscl Stus Txt	Sezr Dt	Statu Titl 1 Txt	Statu Titl 2 Txt
1	PISTOL	HI-POINT PISTOL WITH MAGAZINE	CANADA	EVIDENCE - SINGLE STATUS	TURNED OVER TO ANOTHER AGENCY (PRE-FORFEITURE)	20 MAY 2010	19USCI497	
1	RIFLE-SHOTGUN COMBINATION	WINCHESTER SHOTGUN (12 GA)	PANAMA	ADMINISTRATIVELY FORFEITED	TRANSFER TO UFPD	24 FEBRUARY 2010	OTHERSEIZURE	18USC922
2	GRENADE	MK2 TYPE GRENADES	MEXICO	SEIZED	TURNED OVER TO ANOTHER AGENCY (PRE-FORFEITURE)	30 MARCH 2011	OTHERSEIZURE	18USC922
1	OTHER	HARRIS A2 ULTRALIGHT BI-POD LEGS	DOMINICAN REPUBLIC	EVIDENCE - SINGLE STATUS	REMITTED	08 JANUARY 2009	OTHERSEIZURE	18USC922(E)
1	OTHER	NIKON SCOPE	DOMINICAN REPUBLIC	EVIDENCE - SINGLE STATUS	REMITTED	08 JANUARY 2009	OTHERSEIZURE	18USC922(E)
2	OTHER	.45 CAL PISTOL MAGAZINE	DOMINICAN REPUBLIC	ADMINISTRATIVELY FORFEITED	TRANSFER TO UFPD	08 JANUARY 2009	OTHERSEIZURE	18USC922(E)
2	OTHER	9MM PISTOL MAGAZINES	DOMINICAN REPUBLIC	ADMINISTRATIVELY FORFEITED	TRANSFER TO UFPD	08 JANUARY 2009	OTHERSEIZURE	18USC922(E)
1	PISTOL	AMT SEMI AUTO PISTOL .45CAL (RECEIVER)	DOMINICAN REPUBLIC	ADMINISTRATIVELY FORFEITED	TRANSFER TO UFPD	08 JANUARY 2009	OTHERSEIZURE	18USC922(E)
1	OTHER	MAGAZINE	NEW ZEALAND	SEIZED	HELD BY CUSTOMS	10 JUNE 2011	19USCI436	19CFR123.91
1	RIFLE	RIFLE	NEW ZEALAND	SEIZED	HELD BY CUSTOMS	10 JUNE 2011	19USCI436	19CFR123.91
1	RIFLE	RIFLE	NEW ZEALAND	SEIZED	HELD BY CUSTOMS	10 JUNE 2011	19USCI436	19CFR123.91
1	RIFLE	RIFLE	NEW ZEALAND	SEIZED	HELD BY CUSTOMS	10 JUNE 2011	19USCI436	19CFR123.91
1	RIFLE	RIFLE	NEW ZEALAND	SEIZED	HELD BY CUSTOMS	10 JUNE 2011	19USCI436	19CFR123.91
2	MAGAZINE	9 MM MAGAZINE	DOMINICAN REPUBLIC	ADMINISTRATIVELY FORFEITED	HELD BY CUSTOMS	30 NOVEMBER 2010	19USCI305	19USCI497
2	MAGAZINE	MAGAZINE	DOMINICAN REPUBLIC	ADMINISTRATIVELY FORFEITED	HELD BY CUSTOMS	30 NOVEMBER 2010	19USCI305	19USCI497
1	PISTOL	FN HERSTAL	DOMINICAN REPUBLIC	ADMINISTRATIVELY FORFEITED	HELD BY CUSTOMS	30 NOVEMBER 2010	19USCI305	19USCI497
1	PISTOL	GLOCK 17	DOMINICAN REPUBLIC	ADMINISTRATIVELY FORFEITED	HELD BY CUSTOMS	30 NOVEMBER 2010	19USCI305	19USCI497

Nvtry Qty Amt	Prptry Typ Txt	Prptry Dsc Txt	Going To	Lgl Stus Txt	Phscl Stus Txt	Sezr Dt	Statu Trfl 1 Txt	Statu Trfl 2 Txt
1	PISTOL	GLOCK 19	DOMINICAN REPUBLIC	ADMINISTRATIVELY FORFEITED	HELD BY CUSTOMS	30 NOVEMBER 2010	19USCI305	19USCI1497
12	AMMUNITION	40 CAL AMMUNITION	VENEZUELA	ADMINISTRATIVELY FORFEITED	TRANSFER TO UPDP	07 JUNE 2009	OTHERSEIZURE	19USCI595A
1	OTHER	SIG PRO MAGAZINE	VENEZUELA	ADMINISTRATIVELY FORFEITED	TRANSFER TO UPDP	07 JUNE 2009	OTHERSEIZURE	19USCI595A
1	RIFLE	BUSHMASTER M4 RIFLE/SCOPE/FLASHLIGHT	MEXICO	ADMINISTRATIVELY FORFEITED	HELD BY CUSTOMS	31 AUGUST 2010	19USCI595A(A)	19USCI595A(C)
6224	AMMUNITION	AMMO .22 CAL	MEXICO	ADMINISTRATIVELY FORFEITED	HELD BY CUSTOMS	03 JULY 2010	19USCI497	19USCI595A(D)
20	AMMUNITION	AMMO .243 CAL (20 ROUNDS)	MEXICO	ADMINISTRATIVELY FORFEITED	HELD BY CUSTOMS	03 JULY 2010	19USCI497	19USCI595A(D)
40	AMMUNITION	AMMO .243 WINCHESTER (40 ROUNDS)	MEXICO	ADMINISTRATIVELY FORFEITED	HELD BY CUSTOMS	03 JULY 2010	19USCI497	19USCI595A(D)
40	AMMUNITION	AMMO .270 CAL (40 ROUNDS)	MEXICO	ADMINISTRATIVELY FORFEITED	HELD BY CUSTOMS	03 JULY 2010	19USCI497	19USCI595A(D)
100	AMMUNITION	AMMO .38 CAL SUPER AUTO+P	MEXICO	ADMINISTRATIVELY FORFEITED	HELD BY CUSTOMS	03 JULY 2010	19USCI497	19USCI595A(D)
250	AMMUNITION	AMMO .40 CAL (250 ROUNDS)	MEXICO	ADMINISTRATIVELY FORFEITED	HELD BY CUSTOMS	03 JULY 2010	19USCI497	19USCI595A(D)
100	AMMUNITION	AMMO .45 CAL (100 ROUNDS)	MEXICO	ADMINISTRATIVELY FORFEITED	HELD BY CUSTOMS	03 JULY 2010	19USCI497	19USCI595A(D)
100	AMMUNITION	AMMO 9MM LUGER (100 ROUNDS)	MEXICO	ADMINISTRATIVELY FORFEITED	HELD BY CUSTOMS	03 JULY 2010	19USCI497	19USCI595A(D)
1	PISTOL	LOADED S&W REVOLVER 38 CAL	MEXICO	ADMINISTRATIVELY FORFEITED	HELD BY CUSTOMS	01 DECEMBER 2009	19USCI595A(A)	19USCI595A(D)
1	RIFLE	POLY TECHNOLOGIES 7.62X39 ASSAULT RIFLE	MEXICO	SEIZED	HELD BY CUSTOMS	19 APRIL 2011	19USCI497	19USCI595A(D)
1	OTHER	MAGAZINE	UNITED STATES	SEIZED	REMITTED	09 SEPTEMBER 2009	19USCI497	19USCI595A(D)

Note: The information in this table is taken verbatim from the source to reflect the original data.

Source: US CBP (2011)

Image 9.1 Weapons seized in an arms cache, Afghanistan, 2011



Source: Schroeder (2015d)

In other cases, the data consists of large spreadsheets with thousands of records on weapons seized over several years. An example is provided in Table 9.2, which is a sample of records of more than 30,000 small arms and light weapons taken into custody by the Los Angeles Police Department (LAPD) (Schroeder, 2014b, p. 247). The data includes key details about each item, including the make, model, and calibre of the seized weapons. The records also note the circumstances under which the LAPD took possession of the items, which is critical for disaggregating data on illicit weapons from data on legally-owned weapons turned in to—or temporarily held by—the LAPD.

Data on local seizures often includes items that are not typically considered ‘illicit’. Examples include firearms turned in at local police stations by lawful owners who no longer want them. Thus, to be useful, data on seizures must provide contextual information about the circumstances under which the items were taken into custody. However, even if the contextual information links individual weapons to specific crimes, not all of the weapons linked to a particular crime are the ‘crime gun’. For example, the pistol linked to the crime type ‘Murder-First Degree’ in Table 9.2 could be the weapon used to commit the murder, or it may have been: (1) seized from a suspect at the time of his or her arrest; (2) found on the body of the murder victim; or (3) taken from a bystander. Without more information about this case, it is impossible to determine if the pistol identified in the record was actually used in a murder. This does not mean that such data is of no analytic value; it simply means that analysts must clearly define what they mean by ‘illicit’, exclude records that clearly do not fit this definition, and add caveats regarding any ambiguities in the remaining data.

To illustrate this point, the records displayed in Table 9.2 are colour-coded into groups of ‘crime types’ with similar categorization challenges:

- **Yellow:** The firearms in these records are clearly linked to one or more crimes but their role in the criminal activity is unclear. As noted above, a weapon linked to a first degree murder may or may not be the murder weapon. Without the case file, it is impossible to determine whether these weapons were illicitly possessed or used.
- **Blue:** These firearms are linked to gun crimes. If the weapon is the only one that was seized, it is likely that it is the ‘crime gun’ and can safely be considered ‘illicit’. However, if multiple weapons are linked to the same case, some may not be ‘illicit’; they may have been temporarily confiscated from the suspect at the time of arrest, or from lawful owners who were with the suspect when he or she was arrested.
- **Green and grey:** These weapons were taken from illicit end users—individuals who, by US law, are prohibited from owning firearms. Of all the weapons in the four subcategories identified here, these weapons are the most likely to be ‘illicit’. However, even in these cases, it is possible that some of the firearms were legally-owned weapons that were, for example, temporarily seized from individuals who were with the suspect at the time of arrest.

Table 9.2 also highlights the need for a nuanced understanding of the scope and completeness of the dataset. There are no light weapons (grenade launchers, mortars, recoilless guns, etc.) listed in this excerpt, and the full data file includes records on only 73 light weapons, or less than one per cent of all seized weapons. At first glance, the data appears to indicate that light weapons are almost never encountered by police officers in Los Angeles, but there are other possible explanations. In some US cities, police departments do not take custody of light weapons ammunition (or anything else that presents an explosive hazard). Such items are removed by specialized explosive ordnance disposal units, sometimes referred to as ‘bomb squads’. Because bomb squads are often not part of the agencies that log most seized arms, light weapons ammunition may not be reflected in police seizure data (Schroeder, 2014b, p. 250). Thus, before drawing conclusions about the types of items taken into custody in a given region, researchers should confirm that their data provides a full account of all seizures. Since most datasets do not include explanatory information about the data and how it was compiled, inter-

Table 9.2 Firearms taken into custody by the LAPD, 2009

Type	Description	Manufacturer's name	Caliber	Crime type	Crime date
SHOTGUN	PUMP ACTION	ITHACA/ITHACAGUN	12 GAUGE	SPOUSAL BEATING	25/01/2009
PISTOL	REVOLVER	ROHM	.32 CALIBER	RECEIVING KNOWN STOLEN PROPERTY,<\$400	26/01/2009
PISTOL	SEMI-AUTOMATIC ACTION	HI-POINT(HIGH) FIREARMS	.380 CALIBER	ATTEMPT - MURDER	27/01/2009
PISTOL	AUTOMATIC ACTION	GLOCK	9 MILLIMETER	MURDER:FIRST DEGREE	27/01/2009
PISTOL	SEMI-AUTOMATIC ACTION	STERLING	.25 CALIBER	RECEIVE/ETC KNOWN STOLEN PROPERTY	27/01/2009
PISTOL	SEMI-AUTOMATIC ACTION	BRYCO ARMS	9 MILLIMETER	BRING/POSSESS FIREARM ON SCHOOL GROUNDS	26/01/2009
PISTOL	SEMI-AUTOMATIC ACTION	KIMBER	.45 CALIBER	CARRYING CONCEALED WEAPON WITHIN VEHICLE	26/01/2009
PISTOL	SEMI-AUTOMATIC ACTION	RG (WITH NUMBERS)	.25 CALIBER	POSSESS LOADED WEAPON/PUBLIC	26/01/2009
PISTOL	SEMI-AUTOMATIC ACTION	SIG-SAUER	.357 CALIBER	CARRY LOADED FIREARM IN PUBLIC PLACE	27/01/2009
PISTOL	REVOLVER	SMITH & WESSON	.45 CALIBER	POSSESSION OF UNREGISTERED FIREARM	27/01/2009
RIFLE	BOLT ACTION	RUGER	.223 CALIBER	MFG/SELL/IMPORT ASSAULT RIFLE	27/01/2009
PISTOL	SEMI-AUTOMATIC ACTION	SPRINGFIELD ARMS CO.	.40 CALIBER	POSSESSION MARIJUANA FOR SALE	27/01/2009
PISTOL	SEMI-AUTOMATIC ACTION	HI-POINT(HIGH) FIREARMS	.40 CALIBER	TRANSPORT/SELL/ETC CONTROLLED SUBSTANCE	27/01/2009
PISTOL	SEMI-AUTOMATIC ACTION	COBRA	.380 CALIBER	POSSESSION CONTROLLED SUBSTANCE FOR SALE	28/01/2009
PISTOL	SEMI-AUTOMATIC ACTION	COLT	.38 CALIBER	POSSESSION CONTROLLED SUBSTANCE FOR SALE	28/01/2009
PISTOL	REVOLVER	COLT	.38 CALIBER	POSSESSION CONTROLLED SUBSTANCE FOR SALE	28/01/2009
PISTOL	REVOLVER	COLT	.45 CALIBER	POSSESSION CONTROLLED SUBSTANCE FOR SALE	28/01/2009
PISTOL	SEMI-AUTOMATIC ACTION	COLT	.38 CALIBER	POSSESSION CONTROLLED SUBSTANCE FOR SALE	28/01/2009
PISTOL	SEMI-AUTOMATIC ACTION	COLT	.38 CALIBER	POSSESSION CONTROLLED SUBSTANCE FOR SALE	28/01/2009
PISTOL	REVOLVER	SMITH & WESSON	.357 CALIBER	FELON POSS WEAPON - MAND 6MO JAIL	27/01/2009
PISTOL	REVOLVER	ARMINIUS	.38 CALIBER	POSSESSION OF FIREARM BY FELON/ADDICT/ETC	27/01/2009
PISTOL	SEMI-AUTOMATIC ACTION	SMITH & WESSON	9 MILLIMETER	FELON POSS WEAPON - MAND 6MO JAIL	28/01/2009

Note: The information in this table is taken verbatim from the source to reflect the original data.

Source: LAPD (2013)

views with officials from the source agency are often the best—and sometimes the only—way to determine which, if any, seizures are not reflected in the data.

Other sources of government data

There are several additional sources of government data on illicit weapons, many of which are not readily available in the public domain but can be acquired in some countries via freedom of information requests. Declassified government intelligence reports are a good example. Some government agencies compile detailed reports on the conventional weapons acquired and used by armed groups, particularly in countries where their troops are deployed. While these reports are often classified, some governments release redacted copies in response to freedom of information requests (see Image 9.2). In recent years, the Small Arms Survey has used redacted intelligence reports acquired in this way to:

- identify trends in illicit proliferation not documented elsewhere;
- establish baseline inventories of illicit SALW in specific countries;

Image 9.2 Redacted intelligence reports obtained from the US government (left) and UK government (right) via freedom of information requests

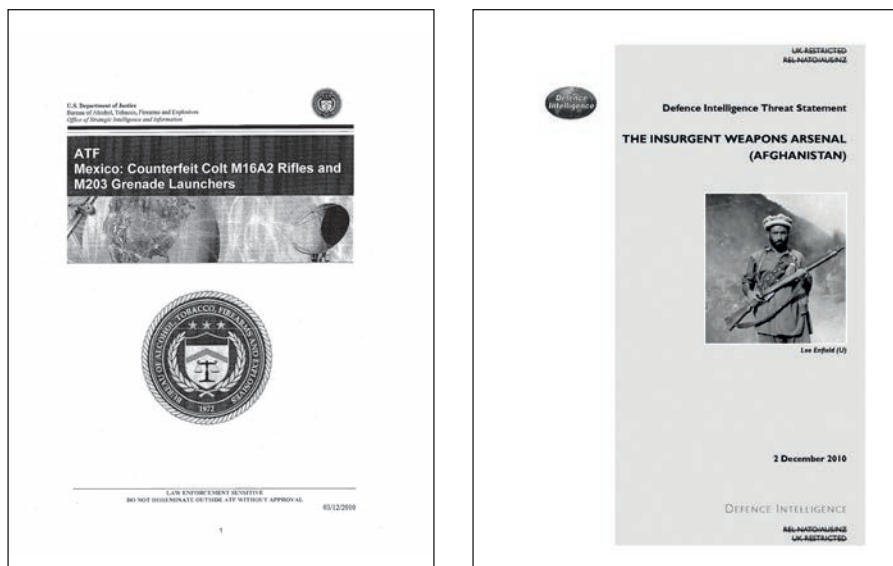

Sources: UK Defence Intelligence (2010); ATF (2010)

- improve understanding of the physical characteristics and capabilities of specific weapons; and
- assess the effectiveness of commonly-used control measures, such as weapons collection programmes.²⁰⁹

While these documents are often valuable reference guides, one should not assume that their content is completely accurate. Even reports from government agencies that specialize in conventional weapons identification occasionally contain errors. As with all sources, information in intelligence reports should be verified and corroborated with information from other sources whenever possible.

Shipping and storage documents

Shipping documents are another rich source of information. Manifests, bills of lading, customs declarations, and other shipping documents are useful for identifying the shipper and other parties to the transfer; the date(s) and route of the shipment; and the destination. Image 9.3 features excerpts from a manifest found on the FRAN-COP, which was transporting thousands of Iranian weapons to Syria when it was intercepted by the Israeli Navy in 2009.

Since smugglers often falsify cargo lists and other information on shipping documents, the data found on these documents should be corroborated with other sources.

Packing lists and other documents that accompany exported weapons also provide important information. Image 9.4 shows a packing list found in a crate of man-portable air defence systems (MANPADS) looted from a depot in Libya. The list identifies the exporter, the export year, the model of exported missiles, and size of the shipment—information that is extremely useful for generating (or corroborating) baseline inventories of small arms and light weapons in conflict zones, failed states, and other countries where weapons are vulnerable to theft, loss, or diversion. Using packing lists and similar documents found in depots after the revolution in Libya, journalists and government contractors were able to piece together a fairly comprehensive overview of MANPADS imported by the Libyan government over a 40-year period.²¹⁰

209 See, for example, Schroeder and King (2012) and Schroeder (2015b; 2016).

210 See Schroeder (2015a, pp. 3–5).

Image 9.3 Ship manifest found on the FRANCOP, November 2009

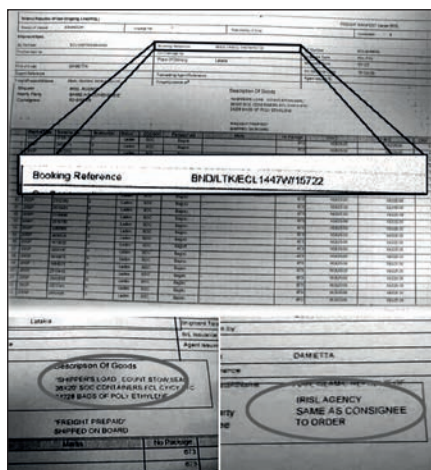

Note: Latakia, Syria, is identified as the ‘place of delivery’. The IRISL is identified as the ‘shipper’.

Image 9.4 Packing list found in a crate of looted MANPADS, Libya, 2011

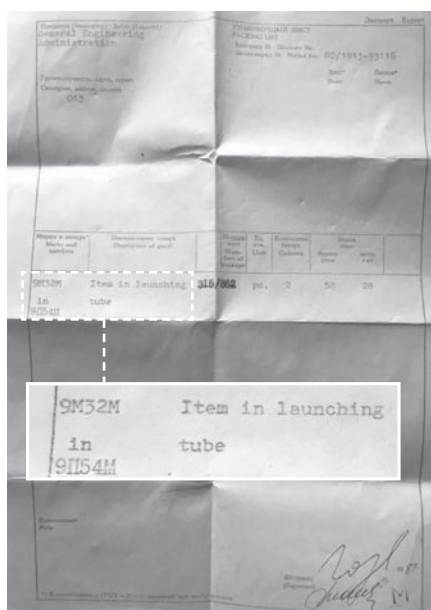

Source: C.J. Chivers

There are several ways to obtain shipping and storage documents. Journalists in the field sometimes encounter them in storage crates that were seized from—or discarded by—armed groups and other unauthorized end users. Documents found with intercepted arms shipments are also sometimes made available by governments as part of public displays of seized weaponry, or in images of illicit weapons posted on government websites.²¹¹ These documents are also sometimes obtainable via freedom of information requests.

While much of their content is relatively straightforward, accurately interpreting and analysing these documents often requires significant technical or contextual knowledge. Journalists and researchers should consult weapons specialists and regional security experts whenever possible.

Analysing social media

Social media is an increasingly important source of data on illicit small arms (see Chapter 8). Photos and video footage posted on Facebook, Twitter, YouTube, and other social media platforms are often the first publicly available evidence of the illicit proliferation of particular models of small arms and light

²¹¹ See, for example, Israel MFA (2009).

Image 9.5 Social media images of MANPADS acquired by armed groups in Syria, 2012–13

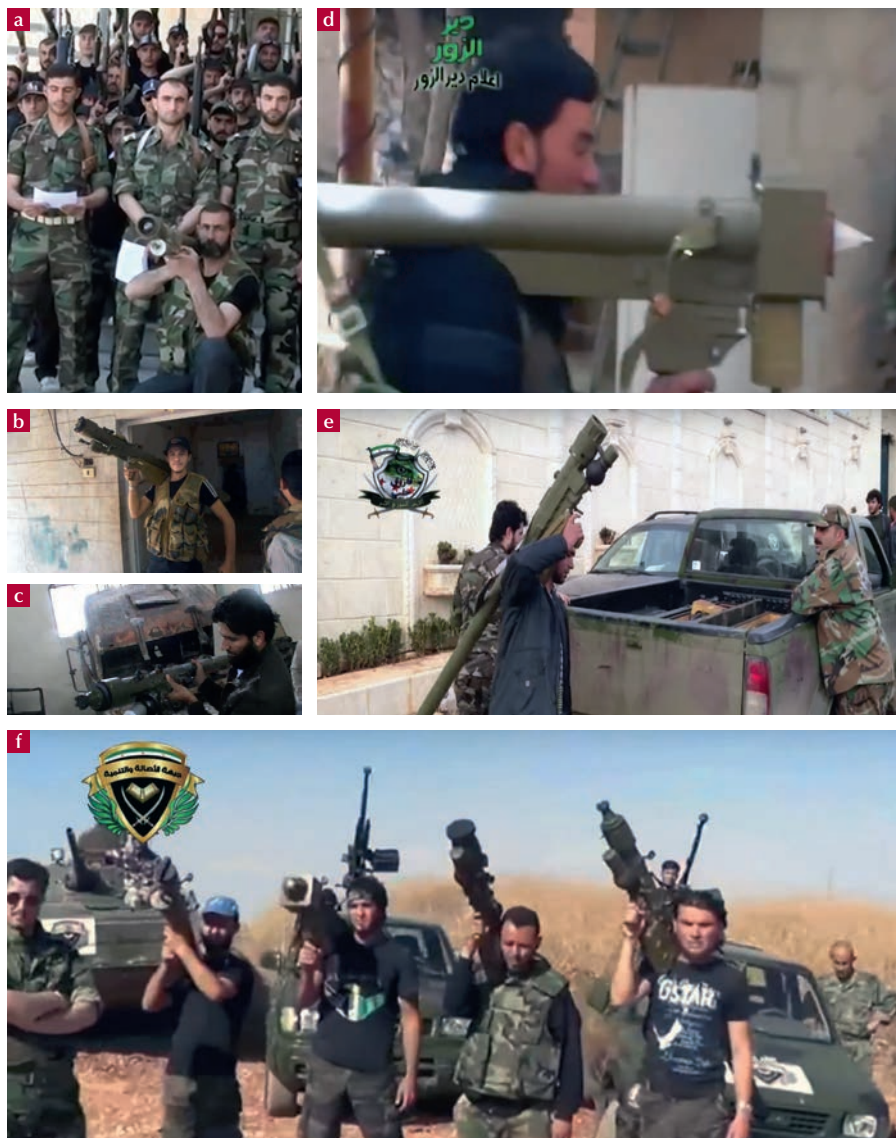

Notes: (a) Syrian rebel with Strela-2-pattern launch tube; (b) Rebel with complete SA-7-pattern MANPADS; (c) Rebel with Igla-1-pattern launch tube; (d) Rebel with FN-6 MANPADS; (e) Rebel with an Igla-5 MANPADS and (f) Rebels with four generations of MANPADS.

Sources: Mhmad Mhmad (n.d.); Chivers (2012c); Higgins (2012); Rebels Deir al-Zour (n.d.); Hazzm Movement's Troop Nine (n.d.); Syri Anwa (n.d.)

weapons. In some cases, these images also provide essential details about the provenance, age, condition, and recipients of illicit weapons. In regions where social media coverage is extensive, these images often provide important clues regarding the quantity of illicit weaponry and changes in proliferation patterns over time.

The immense potential of social media to track illicit weapons proliferation is illustrated by images of MANPADS acquired and used by armed groups during the Syrian civil war. Image 9.5 chronicles the unprecedented proliferation of MANPADS since 2012, when the first early-generation Strela-2 pattern launch tubes were spotted in Syria (via videos posted on YouTube).²¹² Over the next year,

Box 9.1 MANPADS and social media

MANPADS receive a lot of attention on social media. New videos and photos featuring the missile systems are widely circulated and discussed. The net effect of this attention is positive. Images of recently imported and trafficked MANPADS are available more quickly and in greater numbers than ever before, allowing analysts to track their proliferation in near-real time. The decentralized and instantaneous flow of information on social media is dual-edged, however. The Internet does not discriminate on the basis of accuracy; false and misleading information circulates just as quickly and as widely as well-informed analysis.

The sources of misinformation on MANPADS are many and varied. Some erroneous postings are disinformation—deliberately forged or doctored images used to advance a particular strategic or political agenda. An example is the fake ‘Stinger missile’ purportedly discovered by anti-government militia members in Ukraine. Video footage of the ‘discovery’ was posted online, where analysts quickly identified physical anomalies and erroneous markings, the most obvious of which was the misspelling of ‘Tracking Trainer’ as ‘Tracking Rainer’ on the launcher (see Image 9.6). Based on this misspelling, analysts concluded that the designer of the fake missile had based it on an image of the Stinger MANPADS from the video game *Battlefield 3* (Mezzofiore, 2015).

While forgeries and other forms of disinformation are occasionally posted on social media, most misinformation stems from inadvertent errors made by individuals who lack technical knowledge about small arms and light weapons. A common example is the use of specific model designations to refer to entire groups of weapons, including MANPADS. The FIM-92 Stinger is a US-designed MANPADS made famous by the Afghan Mujahideen, who used them to great effect against Soviet aircraft in the 1980s. Their high-profile role in Afghanistan garnered a lot of attention, and ‘Stinger’ became a synonym for ‘MANPADS’, including missile systems of Russian and Chinese origin. This misuse of the term ‘Stinger’ created—and has perpetuated—the impression that US-made Stinger missiles are commonly found on the black market, which is demonstrably false; FIM-92 Stinger missiles are tightly controlled and are now rarely, if ever, acquired by unauthorized end users. Nonetheless, some users of Twitter, Facebook, and other social media platforms continue to refer to all MANPADS as ‘Stingers’.⁶

Referring to MANPADS missiles as complete systems is another common mistake. During the Libyan civil war, a US military official estimated that ‘there were as many as 20,000 of these types of weapons

212 See, for example, Mhmad Mhmad (n.d.).

in Libya before the conflict began' (US AFRICOM, 2011). The official was referring to MANPADS components (individual missiles or launchers) but his statement was widely misinterpreted to mean that the Qaddafi regime had imported 20,000 complete systems. As noted in Chapter 5, a functional MANPADS consists of four main components: a missile, a launch tube, a launcher (gripstock), and a battery unit. Typically, governments import several missiles for every launcher and therefore the number of complete systems in Libya at the time of the uprising was likely only a fraction of the 20,000 MANPADS often cited on social media (Schroeder, 2015a, p. 4). The misidentification of specific models of MANPADS is another source of misinformation. The physical differences between different models of MANPADS are often subtle. This is particularly true for variants of the same model produced in different countries. These variants are often nearly identical in appearance and are sometimes assembled from the same components as the original model. Telling these systems apart requires a trained eye and access to up-to-date reference materials. A final mistake that is often seen on social media is the assumption that all missiles with certain model designations are shoulder-fired. Many missiles with the same model name are fired from both

Image 9.6 Fake 'Stinger missile' featured in a video reportedly taken in Ukraine and posted on Youtube, 2015



Source: Telekanal ICTV (2015)

vehicle-mounted and man-portable launchers. In some cases, the missiles are interchangeable; they can be fired from launchers mounted on vehicles and from gripstocks. In other cases, however, individual missiles with the same model name can only be fired from vehicle-mounted launchers. This often leads to confusion and misreporting. During the civil war in Libya, some analysts prematurely declared that advanced Russian Igla-S MANPADS had been looted from Libyan arsenals after finding emptied crates for 9M342 missiles. The 9M342 missile is fired from man-portable launchers, but also from other launchers.⁷ In fact, the missiles imported by the Libyan government were not shoulder-fired; they were reportedly configured only for use with vehicle-mounted launchers (Schroeder, 2013b, p. 25). Despite the best efforts of many journalists and analysts to point this out, Libya's Igla-S missiles are still occasionally referred to as 'MANPADS' on social media and elsewhere.

Because of the acute threat to military and civilian aircraft posed by MANPADS, their proliferation to and within conflict zones warrants continued coverage. Improving the accuracy of this coverage would increase its utility to analysts and policy-makers, with potentially significant implications for aviation security and counter-trafficking efforts.

Box 9.2 Tips for analysing data on illicit small arms and light weapons

- Make sure that the data is generated or compiled by individuals with the expertise required to accurately identify the weapons referenced in the data. Accurately identifying weapons is difficult and requires significant experience and training. Data generated by individuals without adequate training or experience may contain large numbers of errors, some of which may not be easily identifiable.
- Corroborate data on the make, model, and provenance of weapons. Since even experts sometimes misidentify weapons, it is important to check the make and model of illicit weapons with multiple, independent sources.
- Identify biases in each data source and determine how these biases affect the data. All data is affected by biases. Accounting and controlling for these biases and their effects on data collection and aggregation is an essential part of analysing data on illicit small arms.
- Look for signs of sloppy or inconsistent data entry. Even the most meticulously assembled data will have some errors, but excessive error rates may indicate serious, systemic problems. Obvious errors include duplicate records, misspellings, weapon model designations that do not match the make and/or calibre of the weapon, and inconsistent use of terminology.
- Confirm that the data is representative of the broader population of illicit weapons. As noted above, some datasets on seized weapons may not contain data on certain types of weapons, such as explosive munitions. When possible, ask a representative of the institution that compiled the data if the dataset provides a full accounting of all weapons taken into custody.
- Conduct key informant interviews. Determining whether seized weapons are representative of illicit weapons in a particular country or region is extremely difficult. Law enforcement officers and other local experts with in-depth knowledge of arms trafficking patterns are often well placed to answer this question. Many of these officials are willing to respond to questions about illicit small arms if they can be answered without divulging classified information and if the questions are provided in advance.

⁷ Representatives of the Russian defence industry have claimed that the 9M342 missiles exported to Libya are not compatible with MANPADS gripstocks (Schroeder, 2013b, p. 25). The Small Arms Survey has not independently verified this claim. It is unclear whether other (individual) 9M342 missiles are compatible with both man-portable and vehicle-mounted launchers.

analysts used social media to document the acquisition of increasingly sophisticated MANPADS by various armed groups, culminating in the discovery of a video featuring rebels armed with four generations of MANPADS, including systems not previously seen outside of government control (Schroeder, 2014a, p. 9).

As explained in Chapter 8, social media also has significant limitations. It is often extremely difficult to verify the authenticity, time, and location of events depicted in social media (see Box 9.1). The decentralized and ad hoc nature of social media means that postings on illicit small arms are erratic and that coverage is incomplete. Furthermore, the sprawling digital architecture of social media platforms and the functional limitations of available search engines preclude the systematic and comprehensive identification and collection of relevant images. No single search engine generates a complete set of hits from all relevant sources, and most images of weapons are not identified and tagged in social media posts.

Conclusion

Tracking illicit arms flows is a difficult endeavour. Reliable reports on illicit arms transfers are few and far between, and many of the reports that are published are vague or impossible to corroborate. Until recently, there was too little data from alternate sources to systematically study and report on illicit small arms. This is changing rapidly. Images of illicit weapons are routinely posted on social media, creating new opportunities for creative research and analysis. This data is just the tip of the iceberg: millions of records on seized weapons are sitting on the hard drives of government computers. Recent, successful efforts by the Small Arms Survey to acquire some of this data reveal that governments are willing to release redacted versions of these records if they are approached in the right way. Data and images of millions of additional weapons are hidden in plain sight in more obscure corners of the Internet. When combined with field research conducted by the United Nations, journalists, and other researchers, this data has the potential to revolutionize our understanding of illicit small arms and the role they play in crime and conflict.

Journalists and other researchers have a key role to play in this revolution. Their writing skills and large, diverse audiences make them well suited to bridge the gap between technical analysts and the general public. Furthermore, many

foreign correspondents have the mandate, experience, and networks required to access data on illicit weapons and trafficking networks in areas of the world not covered by social media or UN investigators. With the proper training and resources, researchers can fill these data gaps and, in doing so, significantly improve our understanding of arms flows and their implications for peace and security.

— **Author: Matt Schroeder**

Bibliography

- Ahmad, Riaz. 2012. 'The Way of the Gun: The Legendary Gunsmiths of Darra Adam Khel.' *The Express Tribune*. 4 November.
- Albanian MOD (Ministry of Defence). 2014. 'Annual Report on Export Control for 2014.'
- Anders, Holger. 2015. 'Expanding Arsenal: Insurgent Arms in Northern Mali.' In *Small Arms Survey. Small Arms Survey 2015: Weapons and the World*. Cambridge: Cambridge University Press, pp. 157–85.
- Andrew, Martin. 2015. *How the PLA Fights: Weapons and Tactics of the People's Liberation Army*, rev. edn. Self-published.
- ARDC (US Army Armament Research and Development Center). 1968. *M16 Rifle System: Reliability and Quality Assurance Evaluation*. Technical Report No. 1. Aberdeen Proving Ground: ARDC.
- ARES (Armament Research Services). n.d. Conflict Materiel (CONMAT) Database. Confidential. Perth: ARES.
- . 2015a. 'Global Development and Production of Self-loading Military Rifles.' Unpublished background paper. Perth: ARES.
 - . 2015b. 'Conversion of Blank-firing Handguns in Libya.' Unpublished background paper. Perth: ARES.
 - . 2016a. 'Definitions of Small Arms and Light Weapons Types As Outlined in the International Tracing Instrument.' Unpublished background paper. Perth: ARES.
 - . 2016b. 'AK-103 Self-loading Rifle in Nigeria.' *The Hoplite* (ARES Company Blog). 17 June.
 - . 2016c. 'Swiss HG 85 and OHG 92 Hand Grenades in Libya and Syria.' Confidential research report. Perth: ARES.
 - . 2016d. 'An Introduction to Site Exploitation for Weapons Technical Intelligence.' ARES training module. Perth: ARES.
 - . 2017. *Defining and Classifying Small Arms and Light Weapons*. Confidential. Perth: ARES.
 - . 2018. *Introduction to Ordnance Identification*. Perth: ARES.
 - . Forthcoming. *The ARES Arms and Munitions Classification System (ARCS)*. Perth: ARES.
- Arvidsson, P.G. 2009. 'Weapons and Sensors.' Presentation via DTIC.
- ATF (United States Bureau of Alcohol, Tobacco, Firearms and Explosives). 2010. 'Mexico: Counterfeit Colt M16A2 Rifles and M203 Grenade Launchers.' Office of Strategic Intelligence and Information.
- . 2015. 'Semiautomatic Assault Weapons and Large Capacity Ammunition Feeding Devices (SAWs and LCAFDs).' Accessed 9 February.
 - . 2016. 'Firearms—Guides—Importation and Verification of Firearms, Ammunition—Firearms Verification Overview.'
 - . 2018. 'Firearms Verification: Gun Control Act Definitions: Shotgun.' 26 April.
- Bacon, Lance. 2011. 'New IR Illumination Helps Soldiers Own the Night.' *Army Times*. 28 January.
- Ballou, James L. 2010. 'The Rarest MG on the Line.' *Small Arms Review*. Vol. 13, No. 8.
- Barnes, Frank C. and W. Todd Woodard. 2016. *Cartridges of the World: A Complete and Illustrated Reference for More Than 1500 Cartridges*, 15th edn. Iola: Gun Digest Books.

- BASC (British Association for Shooting and Conservation). 2009. *Rifles, Calibres and Land: Advice for Enquiry Officers*. Wrexham: BASC.
- Berman, Eric G. 2011. *Craft Production of Small Arms*. Research Note No. 3. Geneva: Small Arms Survey. March.
- and Mihaela Racovita. 2015. *Under Attack and Above Scrutiny? Arms and Ammunition Diversion from Peacekeepers in Sudan and South Sudan, 2002–14*. HSBA Working Paper No. 37. Geneva: Small Arms Survey. July.
- , Mihaela Racovita, and Matt Schroeder. 2017. *Making a Tough Job More Difficult: Loss of Arms and Ammunition in Peace Operations*. Report. Geneva: Small Arms Survey. October.
- Bevan, James. 2008. 'Arsenals Adrift: Arms and Ammunition Diversion.' In Small Arms Survey. *Small Arms Survey 2008: Risk and Resilience*. Cambridge: Cambridge University Press, pp. 41–75.
- Brander, Michael. 1988. *The Big Game Hunters*. London: The Sportsman's Press.
- Browning, n.d. 'Date Your Firearm—Hi Power Pistol.'
- Bull, Stephen. 2004. *Encyclopedia of Military Technology and Innovation*. Westport: Greenwood Press.
- Butler, David F. 1971. *United States Firearms: the First Century, 1776–1875*. New York: Winchester Press.
- CALL (Center for Army Lessons Learned). 2007. *Tactical Site Exploitation and Cache Search Operations: Tactics, Techniques, and Procedures*. Fort Leavenworth: Center for Army Lessons Learned.
- Carlson, Khristopher, Joanna Wright, and Hannah Dönges. 2015. 'In the Line of Fire: Elephant and Rhino Poaching in Africa.' In Small Arms Survey. *Small Arms Survey 2015: Weapons and the World*. Cambridge: Cambridge University Press, pp. 6–35.
- Carman, W.Y. 1955. *History of Firearms. From Earliest Times to 1914*. Abingdon: Routledge.
- CAST (Centre for Analysis of Strategies and Technologies) et al. 2003. 'Workshops and Factories: Products and Producers.' In Small Arms Survey. *Small Arms Survey 2003: Development Denied*. Oxford: Oxford University Press, pp. 9–55.
- CBS Sacramento. 2016. 'Sacramento at Center of Untraceable "Ghost Gun" Surge.' *CBS13*. Digital Edition: 16 May.
- Cerakote (NIC Industries, Inc.). 2017a. 'Introducing Cerakote Elite.' Press release. 16 January.
- . 2017b. *Cerakote Training Manual: H-Series and Cerakote Elite*. White City: NIC Industries.
- . 2018. 'Test Results.'
- Chait, Richard, Duncan Long, and John Lyons. 2006. *Critical Technology Events in the Development of the Stinger and Javelin Missile Systems: Project Hindsight Revisited*. Center for Technology and National Security Policy. Washington, D.C.: National Defense University Press.
- Channel 4. 2016. '24 Hours in Police Custody.' Series 4, Episode 7: 'Lethal Weapon.' Originally Aired in the UK, 1 June.
- Chinn, George M. 1955. *The Machine Gun, Vol. 4, Parts X and XI: Design Analysis of Automatic Firing Mechanisms and Related Components*. Washington, D.C.: Bureau of Ordnance, Department of the Navy.
- Chivers, C.J. 2012a. 'Syrians Place Booby-trapped Ammunition in Rebels' Guns.' *The New York Times*. 19 October.
- . 2012b. 'What a Crate in Syria Says about Saudi Help to the Rebels.' *The New York Times*. 11 October.
- . 2012c. 'In Syria, Potential Threat to Government Air Power Emerges.' *The New York Times*. 7 August.
- Choat, Chris. 2012. 'Barrett M107A1 Rifle.' *Small Arms Defense Journal*. Vol. 3, No. 3.
- Chumak, Ruslan and Konstantin Solovyov. 2001. 'Cartridges for a Super-machine Gun.' *Kalashnikov: Arms, Ammunition, and Equipment*. Issue No. 1/2011. St Petersburg: Azimut.

- Concern Kalashnikov. 2014. 'Americans Stock Up on Kalashnikov Cartridges.' Press release. 26 April.
- . 2018. 'About Company.' Accessed 7 June 2018.
- Conflict Armament Research. 2016. *Standardization and Quality Control in Islamic State's Military Production*. Dispatch from the Field. London: Conflict Armament Research, Ltd. December.
- Cross, Kenneth, Ove Dullum, N.R. Jenzen Jones, and Marc Garlasco. 2016. *Explosive Weapons in Populated Areas: Technical Considerations Relevant to Their Use and Effects*. Perth: ARES.
- Datamyne. n.d. 'Datamyne Database.' Accessed September 2011.
- Dawson, Ty. 2009. 'CSI: Baghdad?' Company Command—Building Combat-ready Teams.' *ARMY Magazine*.
- Debelle, Raymond and Nicolas Florquin. 2015. 'Waning Cohesion: The Rise and Fall of the FDLR-FOCA.' In Small Arms Survey. *Small Arms Survey 2015: Weapons and the World*. Cambridge: Cambridge University Press, pp. 186–215.
- de Tésières, Savannah. 2017. *Measuring Illicit Arms Flows: Niger*. Briefing Paper. Geneva: Small Arms Survey. March.
- Diehl, Alexander and N.R. Jenzen-Jones. 2012. *Small Arms Ammunition (SAA): Basic Identification Techniques*. Presentation (self-published).
- Diethelm, Pascal and Martin McKee. 2011. 'Nicotine: Not Just an Unregulated Poison but Now a Potential Chemical Weapon.' *European Journal of Public Health*, Vol. 21, No. 6.
- DIO (Defense Industries Organization). n.d. 'Monotube Rocket Launcher 107 mm.'
- Dreyfus, Pablo, Nic Marsh, and Matt Schroeder. 2009. 'Sifting the Sources: Authorized Small Arms Transfers.' In Small Arms Survey. *Small Arms Survey 2009: Shadows of War*. Cambridge: Cambridge University Press, pp. 6–60.
- DSCA (Defense Security Cooperation Agency). n.d. 'Foreign Military Sales.'
- Dullum, Ove. 2009. *The Rocket Artillery Reference Book*. Oslo: Forsvarets Forskningsinstitut (FFI).
- , N.R. Jenzen-Jones, D.G. Palacio, K. Fulmer, and C. Lincoln-Jones. 2017. *Indirect Fire: A Technical Analysis of the Employment, Accuracy, and Effects of Indirect-fire Artillery Weapons*. Perth: ARES.
- European Commission. 2016. 'Stronger Control of Firearms Across the EU.' Brussels: European Commission.
- European Union. n.d. 'Tenders Electronic Daily.'
- . 2017. 'Eighteenth Annual Report According to Article 8(2) of Council Common Position 2008/944/CFSP Defining Common Rules Governing the Control of Exports of Military Technology and Equipment.' *Official Journal of the European Union*. 16 May.
- Fadala, Sam. 2004. 'Hunting Drives Today's Blackpowder Market.' *Shooting Industry*. May.
- Ferguson, Jonathan. 2014a. *Blank Ammunition and Conversion Potential*. Unpublished background paper. Geneva: Small Arms Survey.
- . 2014b. *Mortars and Anti-tank Guided Weapons (ATGWs)*. ARES Research Note No. 2. Unpublished. Perth: ARES.
- . 2014c. 'Differential Identification of NSV and Kord Heavy Machine Guns.' *The Hoplite* (ARES company blog). 27 November.
- . 2015. *Cartridge Headspace*. ARES Research Note No. 7. Perth: ARES.
- . 2016. 'Myths and Misconceptions: the M1 "ping".' *The Hoplite* (ARES company blog). 31 December.
- . 2017a. 'Pakistani AK-style Bolt-action Rifle.' *The Hoplite* (ARES company blog). 14 December.

- . 2017b. 'PA Luty 9mm Submachine Guns.' *The Hoplite* (ARES company blog). 13 August.
- . 2017c. 'British Enfield SA80 Part 5: SA80 A1 vs A2'. *The Hoplite* (ARES company blog). 20 May.
- and N.R. Jenzen-Jones. 2014a. *Conversion of Blank-firing and Deactivated Firearms*. Research Note No. 10 (unpublished). Perth: ARES.
- and N.R. Jenzen-Jones. 2014b. *An Introduction to Basic AK Type Rifle Identification*. Research Note No. 6. Perth: ARES.
- , N.R. Jenzen-Jones, and Ian McCollum. 2014. *Marking of Critical Firearms Components as Applied to Modular Weapons*. Confidential. Perth: ARES.
- and Paul William. 2014. *Converted Firearms: Conversion of Blank-firing Weapons and of Semi-automatic to Automatic Weapons*. Unpublished background paper. Geneva: Small Arms Survey.
- Florquin, Nicolas. 2013. 'Price Watch: Arms and Ammunition at Illicit Markets.' In Small Arms Survey. *Small Arms Survey 2013: Everyday Dangers*. Cambridge: Cambridge University Press, pp. 250–81.
- . 2014. 'Documenting Weapons in Situations of Armed Conflict: Methods and Trends.' Research Note No. 42. Geneva: Small Arms Survey. June.
- and Benjamin King. 2018. *From Lethal to Legal: Converted Firearms in Europe*. Report. Geneva: Small Arms Survey. April.
- and Jonah Leff. 2014. 'Across Conflict Zones: Ammunition Profiling.' In Small Arms Survey. *Small Arms Survey 2014: Women and Guns*. Cambridge: Cambridge University Press, pp. 178–211.
- FN (Fabrique Nationale d'Armes de Guerre S.A.). c.1990. 'G.P.M.G. Infantry.' Sales brochure.
- Forero, Juan. 2010. 'Venezuela Acquires 1,800 Antiaircraft Missiles from Russia.' *The Washington Post*. 11 December.
- Forgotten Weapons. 2017a. 'Improvised and Craft-Built Firearms w/ Jonathan Ferguson and Nic Jenzen-Jones.' YouTube. 27 December.
- . 2017b. 'Schmeisser's MP-18,I - The First True Submachine Gun.' YouTube. 14 August.
- . 2017c. 'Repurposing Obsolete Rifles: The Lebel R35 Carbine.' YouTube. 19 December.
- France (Service-public.fr). n.d. 'Armes.'
- Frank, Matthias, et al. 2012. 'Ballistic Parameters and Trauma Potential of Direct-acting, Powder-actuated Fastening Tools (Nail Guns).' *International Journal of Legal Medicine*. Vol. 126, No. 2. March, pp. 217–22.
- Fulmer, Kenton, N.R. Jenzen-Jones, and Yuri Lyamin. 2016. 'Introduction to the 9M113 Konkurs ATGM.' *The Hoplite* (ARES company blog). 28 July.
- Gander, Terry. 1993. *The Machine Gun: A Modern Survey*. Sparkford: Patrick Stephens.
- Gatehouse, Gabriel. 2011. 'Gaddafi "Captor" Brandished Golden Pistol.' *BBC News*. 20 October.
- . 2016. 'My Search for Gaddafi's Golden Gun.' *BBC Magazine*. 3 February.
- Gaub, Florence and Zoe Stanley-Lockman. 2017. 'Defence Industries in Arab States: Players and Strategies.' Chaillot Paper No. 141. Paris: European Union Institute for Security Studies (EUISS). March.
- van Ginkel, Bibi. 2012. *Towards the Intelligent Use of Intelligence: Quis Custodiet Ipsos Custodes?* The Hague: International Centre for Counter-Terrorism.
- Goad, K.J.W. and D.H.J. Halsey. 1982. *Ammunition (Including Grenades and Mines)*. Brassey's Battlefield Weapons Systems and Technology, Vol. III. Oxford: Brassey's Publishers.
- GPO (US Government Publishing Office). n.d. 26 U.S.C. 5845—DEFINITIONS.

- Greene, Owen. 2006. 'Ammunition for Small Arms and Light Weapons: Understanding the Issues and Addressing the Challenges.' In *Targeting Ammunition: A Primer*. Geneva: Small Arms Survey, pp. 1–13. June.
- Greener, W.W. 1910. *The Gun and Its Development*, 9th edn. London: Cassel and Company.
- Grzybowski, Janis, Nicholas Marsh, and Matt Schroeder. 2012. 'Piece by Piece: Authorized Transfers of Parts and Accessories.' In Small Arms Survey. *Small Arms Survey 2012: Moving Targets*. Cambridge: Cambridge University Press, pp. 240–281.
- Gsell, André and Matthias Nowak. 2018. *Handmade and Deadly: Craft Production of Small Arms in Nigeria*. Briefing Paper. Geneva: Small Arms Survey. June.
- Gupta, Girish. 2017. 'Exclusive: Venezuela Holds 5,000 Russian Surface-to-air MANPADS Missiles.' Reuters. 22 May.
- Hales, Gavin, Chris Lewis, and Daniel Silverstone. 2006. 'Gun Crime: the Market in and Use of Illegal Firearms.' Home Office Research Study No. 298. London: Home Office. December.
- Hays, G. and N.R. Jenzen-Jones. 2018. *Beyond State Control: A Guide to Improvised and Craft-produced Small Arms and Light Weapons*. Report. Geneva: Small Arms Survey.
- Hazzm Movement's Troop Nine. n.d. 'Farouq Aleppo Ready with Cobra and Igla Missiles for Airforces' [in Arabic]. YouTube. Posted 22 February 2013.
- Herron, Patrick, Nic Marsh, and Matt Schroeder. 2011. 'Larger but Less Known: Authorized Light Weapons Transfers.' In Small Arms Survey. *Small Arms Survey 2011: States of Security*. Cambridge: Cambridge University Press, pp. 8–41.
- Higgins, Eliot. 2012. 'New Type Of Shoulder Mounted Surface To Air Missile Captured By The Opposition.' *Brown Moses Blog*. November.
- HMSO (Her Majesty's Stationery Office). 2010. 'Specifications for the Adaptation of Shotgun Magazines and the Deactivation of Firearms.' London: HMSO.
- Hodgkins, Kelly. 2015. 'The First 3D-printed Revolver Fires 8 Shots, Just Add a Roofing Nail and Elastic.' *Digital Trends*. 24 November.
- Hogg, Ian V. 2001. *Mortars*. Ramsbury: The Crowood Press.
- Holtom, Paul. 2008. *Transparency in Transfers of Small Arms and Light Weapons*. Policy Paper. Solna: Stockholm International Peace Research Institute. July.
- and Irene Pavesi. 2017. *Trade Update 2017: Out of the Shadows*. Report. Geneva: Small Arms Survey. September.
- , Irene Pavesi, and Christelle Rigual. 2014. 'Trade Update: Transfers, Retransfers, and the ATT.' In Small Arms Survey. *Small Arms Survey 2014: Women and Guns*. Cambridge: Cambridge University Press, pp. 108–143.
- Home Office (UK). 2016. *Guide on Firearms Licensing Law*. London: Home Office. April.
- IDA (Institute for Defence Analyses). 1995. *Soviet/Russian Armor and Artillery Design Practices: 1945–1995*. Quantico: United States Marine Corps Intelligence Agency.
- IMAS (International Mine Action Standards). 2003. Glossary of Mine Action Terms, Definitions and Abbreviations. IMAS 04.10.
- IMC (International Military Commission). 1868. Declaration Renouncing the Use, in Time of War, of Explosive Projectiles Under 400 Grammes Weight (Declaration of Saint Petersburg). Adopted 11 December.

- Indian National Informatics Centre. 2013. 'Mission Mode Project on e-Procurement.' Consolidated Tender Information for States and UT's.
- Instituto Sou da Paz. 2014. *Where Do Weapons of Crime Come From? An Analysis of Weapons Seized in 2011 and 2012 in Sao Paulo*. Sao Paulo: Instituto Sou da Paz.
- IPC (International Peace Conference 1899). 1899. Declaration (IV,3) Concerning Expanding Bullets. The Hague, 29 July.
- Israel MFA (Ministry of Foreign Affairs). 2009. 'Iranian Arms Seized on MV Francop.' Flickr. 3 November.
- IUCN (The International Union for Conservation of Nature). 2016. 'IUCN Reports Deepening Rhino Poaching Crisis in Africa.' 9 March.
- Jenzen-Jones, N.R. 2012a. 'The 100-Series Kalashnikovs: A Primer'. *Small Arms Review*. September.
- 2012b. 'Update: RPG-7 Projectiles in Syria.' *The Rogue Adventurer*. 14 October.
- 2014a. *Identifying Marks on AK Type Rifles*. Perth: ARES.
- 2014b. *Following the Headstamp Trail: An Assessment of Small-calibre Ammunition Documented in Syria*. Working Paper 18. Geneva: Small Arms Survey. April.
- 2014c. 'Which Lightweight Automatic Grenade Launcher for the Australian Defence Force?' *Small Arms Defence Journal*. Vol. 6, No. 1. Henderson: Chipotle.
- 2015a. *Automatic Grenade Launchers*. Research Note No. 48. Geneva: Small Arms Survey. February.
- 2015b. *Guided Mortar Systems*. Research Note No. 51. Geneva: Small Arms Survey. April.
- 2015c. *Recoilless Weapons*. Research Note No. 55. Geneva: Small Arms Survey. December.
- 2015d. 'Small Arms and Additive Manufacturing: An Assessment of 3D-printed Firearms, Components, and Accessories.' In King, Benjamin and Glenn McDonald, eds. *Behind the Curve: New Technologies, New Control Challenges*. Occasional Paper No. 32. Geneva: Small Arms Survey, pp. 43–74.
- 2015e. 'A Rifle's Journey from Belgium to Gaza.' *BBC News Magazine*. Digital edition: 8 December.
- 2015f. *Deactivated Firearms in Europe*. ARES Briefing. Unpublished.
- 2016a. *Chambering the Next Round: Emergent Small-calibre Cartridge Technologies*. Working Paper 23. Geneva: Small Arms Survey. February.
- 2016b. 'Russian AK-103 Self-loading Rifle for Sale in Iraq via Social Media.' *The Hoplite* (ARES Company Blog). 21 August.
- 2016c. *A Tale of Two Rifles: The Proliferation of F2000 and AK-103 Self-loading Rifles Exported to Libya in 2004–2009*. Research Report No. 5. Perth: ARES.
- 2017a. *Anti-tank Guided Weapons*. Research Note No. 16, 2nd edn. Geneva: Small Arms Survey. June.
- 2017b. *Man-portable Air Defence Systems (MANPADS)*. Research Note No. 1, 2nd edn. Geneva: Small Arms Survey. June.
- 2017c. 'C-19: The New Canadian Ranger Rifle.' *Small Arms Defense Journal*. Vol. 8, No. 6.
- 2017d. *Global Development and Production of Self-loading Service Rifles: 1896 to Present Day*. Working Paper No. 25. Geneva: Small Arms Survey.
- 2018. 'Introduction.' In McCollum, Ian, Rob Stott, and Larry Vickers. *Vickers Guide: Kalashnikov*, Vol. 1. Nashville: Mott Lake Publishing.
- and Stefan Elliott. 2015. *Estimating Year of Production for FN Herstal FAL Rifles*. ARES Research Note No. 9. Perth: ARES. August.
- and G. Hays. 2016. *Improvised and Craft-produced Small Arms and Light Weapons*. Unpublished.

- and Ian McCollum. 2015. *Counterfeit Antique Firearms Imported into the US*. ARES Briefing. Unpublished.
- and Ian McCollum. 2016. *Custom Application of Import Markings: Manufacturer Survey and Analysis*. Unpublished background paper. Perth: ARES.
- and Ian McCollum. 2017. *Web Trafficking: Analysing the Online Trade of Small Arms and Light Weapons in Libya*. Working Paper 26. Geneva: Small Arms Survey. April.
- and Tom Noakes. Forthcoming. *North Korean Covert Packaging: Decoding Spurious Markings on DPRK Arms and Munitions Crates*. Perth: ARES.
- and Samuel Paunila. 2017. *Explosive Weapon Effects Overview*. Final Report of the Characterisation of Explosive Weapons Project. Geneva: GICHD.
- and Maxim Popenker. 2015. *The Russian GM-94 Grenade Launcher*. Arms and Munitions Brief No. 2. Perth: Armament Research Services.
- and Damien Spleeters. 2015. 'Identifying and Tracing the FN Herstal FAL Rifle: Documenting Signs of Diversion in Syria and Beyond.' Perth: ARES. August.
- and Anthony G. Williams. 2016. 'Open-tip and Expanding Projectiles: Development, Acquisition, and Use History.' ARES briefing. Unpublished. Perth: ARES.
- Jespersen, Bjørn Holst. Forthcoming. *An Introduction to Photogrammetry: Using Perspective Analysis to Infer the Trajectory of Munitions*. Perth: ARES.
- Johnston, Gary P. and Thomas B. Nelson. 2010. *The World's Assault Rifles*. Alexandria: Ironside International Publishers, Inc.
- Jones, Richard D. and Leland S. Ness. 2013. *Jane's Infantry Weapons 2013–14*. London: IHS Jane's.
- Khakee, Anna with Nicolas Florquin. 2005. 'Sourcing the Tools of War: Small Arms Supplies to Conflict Zones.' In Small Arms Survey. *Small Arms Survey 2005: Moving Targets*. Oxford: Oxford University Press, pp. 158–77.
- Killicoat, Phillip. 2007. 'Weaponomics: The Global Market for Assault Rifles.' World Bank Policy Research Working Paper 4202. Oxford University.
- King, Benjamin. 2015. *From Replica to Real: An Introduction to Firearms Conversions*. Issue Brief No. 10. Geneva: Small Arms Survey. February.
- Kirkpatrick, David D. 2015. 'Leaked Emirati Emails Could Threaten Peace Talks in Libya.' *The New York Times*. 12 November.
- Koll, Christian. 2009. *Soviet Cannon: A Comprehensive Study of Soviet Guns and Ammunition in Calibres 12.7mm to 57mm*. Self-published.
- Krupař, Stanislav. 2016. 'Našel jsem Kaddáfího pistoli.' *Newsweek* (Czech edition). No. 21, 2016.
- Lacy, John F. 1989. *The Remington 700: A History and Users Manual*. Elk City: self-published.
- LAPD (Los Angeles Police Department). 2013. Records of Firearms, Ammunition and Other Weapons Seized or Confiscated by the Los Angeles Police Department from 2007–12. Obtained under the Freedom of Information Act by the Small Arms Survey.
- Linning, Stephanie. 2016. "'Assassination Kits' Containing Gangsters' 'Weapon of Choice', Silencer and Bullets Back on Sale in Britain Seven Years after Police Smashed Market in the Guns.' *Mail Online*. 12 April.
- Lisker, Sam. 2018. 'Colt Patents for Semi Automatic Pistols.'
- Luty, P.A. 1998. *Expedient Homemade Firearms: The 9mm Submachine Gun*. Boulder: Paladin Press.

- Maxim, Hiram P. 1909. 'Silent Firearm.' US Patent 916885 A.
- McCollum, Ian. 2012. 'Maxim Silencer.' *Forgotten Weapons*.
- . 2014a. '44 Bore – 7.62 x 39 mm AK Rifles Modified to Fire 7.92 x 33 Kurz Ammunition.' *The Hoplite* (ARES company blog). 8 September.
 - . 2014b. 'Proof Marks and Identification: Understanding Firearms Markings 1880–1945.' Presentation for the Association of Firearms and Toolmark Examiners.
- , Andrew Stott, and Larry Vickers. 2018. *Vickers Guide: Kalashnikov*, Vol. 1. Nashville: Mott Lake Publishing.
- McDonald, Glenn, Anna Alvazzi del Frate, and Moshe Ben Hamo Yeger. 2017. *Arms Control 2.0: Operationalizing SDG Target 16.4*. Briefing Paper. Geneva: Small Arms Survey. October.
- Mhmad Mhmad. n.d. 'Collective Desertion from the Syrian Army to Join Abu Bakr as-Siddiq Battalion in Ar Rastan, Syria' [in Arabic]. YouTube. Posted 26 April 2012.
- Mezzofiore, Gianluca. 2015. 'Ukraine: Pro-Russia Separatists Use Fake Battlefield 3 Stinger Missiles to Accuse US of Weapon Supply.' *International Business Times*. 14 November. Updated 14 November 2017.
- Mueller, Chester and John Olson. 1968. *Small Arms Lexicon and Concise Encyclopedia*. South Hackensack: Shooter's Bible.
- Nammo. 2014. *Nammo Ammunition Handbook*, 2nd edn.
- NATO (North Atlantic Treaty Organization). 2018. *Allied Joint Doctrine for Countering Improvised Explosive Devices*. Edition C Version 1. AJP-3.15. February.
- Ness, Leland and Anthony G. Williams. 2007. *Jane's Ammunition Handbook 2007–2008*. London: Jane's Information Group.
- and Anthony G. Williams. 2015. *IHS Jane's Weapons: Ammunition 2015–2016*. London: IHS Jane's.
- Netherlands MFA (Ministry of Foreign Affairs). n.d. 'Maandelijkse rapportage uitvoer militaire goederen.'
- Newhouse, Paul. 2011. 'Rockets vs. Recoilless.' *Small Arms Defense Journal*. Vol. 1, No. 3. Henderson: Chipotle. August.
- NISAT (Norwegian Initiative on Small Arms Transfers). n.d. 'Small Arms Trade Database.'
- NSWC (Naval Surface Warfare Center). n.d. 'Warheads Primer.'
- Oppenheimer, A.R. 2008. *IRA – The Bombs and the Bullets: A History of Deadly Ingenuity*. Newbridge: Irish Academic Press.
- Parker, Sarah, ed. 2016. *The Arms Trade Treaty: A Practical Guide to National Implementation*. Handbook. Geneva: Small Arms Survey. August.
- Paulson, Alan C. 1996. *Silencer: History and Performance Volume 1: Sporting and Tactical Silencers*. Boulder: Paladin Press.
- Pavesi, Irene. 2016. *Trade Update 2016: Transfers and Transparency*. Geneva: Small Arms Survey. June.
- Pavlovich, Steven. 2016. 'Illicit Firearms Makers of South East Asia (Guns on the Doorstep):' Briefing Note. Western Australian Police.
- Peregrine (Peregrine Monolithics). 2015a. 'Solid Copper Reloading Bullets.'
- . 2015b. 'Solid Brass Reloading Bullets.'
- Persi Paoli, Giacomo. 2015. 'From Firearms to Weapon Systems: Challenges and Implications of Modular Design for Marking, Record-keeping, and Tracing'. In King, Benjamin and Glenn McDonald, eds. *Behind the Curve: New Technologies, New Control Challenges*. Geneva: Small Arms Survey. February.

- Philippine DND (Department of National Defense). 2013. 'DND Bids and Awards Committee.'
- Phillips, Michael M. 2011. 'Launching the Missile That Made History.' *The Wall Street Journal*. 1 October.
- Poaching Facts. 2018. 'Rhino Poaching Statistics.'
- Ponomarev, Yuri. 2004. 'Biografiya Patrona: Kalashnikov.' *Oruzhie i Amunitsiya*, No. 8. St Petersburg: Azimut.
- Poongsan. 2016. 'Ammunition and Explosives.' Sales catalogue.
- Popenker, Maxim and Anthony G. Williams. 2004. *Assault Rifle: The Development of the Modern Military Rifle and its Ammunition*. Ramsbury: The Crowood Press.
- . 2008. *Machine Gun: The Development of the Machine Gun from the Nineteenth Century to the Present Day*. Ramsbury: The Crowood Press
- . 2012. *Sub-machine Gun: The Development of Sub-machine Guns and Their Ammunition from World War 1 to the Present Day*. Ramsbury: The Crowood Press.
- Raytheon (Raytheon Company). 2018. 'Pike Munition.'
- RCMP (Royal Canadian Mounted Police). 2012. 'Replica Firearms.' Information sheet No. CFP 1220 E (2013 12) V4. Canadian Firearms Program.
- Rebels Deir al-Zour. n.d. 'The First Time Heavy Rockets against Assad's Air Force' [in Arabic]. YouTube. Posted 11 February 2013.
- Reed, Rob. 2016. 'Troy Defense GAU-5/A/A "Son Tay Raider" Limited Edition Carbine at 2016 SHOT Show.' *All Outdoor*. 22 January.
- Remington (Remington Arms Company). n.d. 'Autoloading Shotguns.' Accessed 16 January 2018.
- Roach, Kent. 2009. 'When Secret Intelligence Becomes Evidence: Some Implications of Khadr and Charkaoui II.' *The Supreme Court Law Review: Osgoode's Annual Constitutional Cases Conference*, Vol. 47, Art. 6.
- Rottman, Gordon L. 2011. *The M16*. Osprey Weapon No. 14. Oxford: Osprey Publishing.
- Rowe, Walter F. 2015. 'Chemical Methods in Firearms Analysis.' In Siegel, Jay A. *Forensic Chemistry: Fundamentals and Applications*. Chichester: John Wiley and Sons.
- Ryan, J.W. 1982. *Guns, Mortars and Rockets*. Brassey's Battlefield Weapons Systems and Technology, Vol. III. Oxford: Brassey's Publishers.
- Saab. 2016. 'Saab RBS 70 NG VSHORAD: An Edge on the Battlefield.' Marketing brochure.
- Samuel, Henry. 2015. 'Charlie Hebdo Shootings: Automatic Rifles Used in Paris Attacks Traced to Shop in Slovakia.' *The Telegraph*. 18 February.
- Schroeder and Hetzendorfer. n.d. '2-Bore History.'
- Schroeder, Matt. 2013a. 'Captured and Counted: Illicit Weapons in Mexico and the Philippines.' In Small Arms Survey. *Small Arms Survey 2013: Everyday Dangers*. Cambridge: Cambridge University Press, pp. 282–317.
- . 2013b. *The MANPADS Threat and International Efforts to Address it: Ten Years after Mombasa*. Washington D.C.: Federation of American Scientists.
- . 2014a. *Fire and Forget: The Proliferation of Man-portable Air Defence Systems in Syria*. Issue Brief No. 9. August.
- . 2014b. 'On the Record: Illicit Weapons in the United States.' In Small Arms Survey. *Small Arms Survey 2014: Women and Guns*. Cambridge: Cambridge University Press, pp. 244–73.
- . 2014c. *Rogue Rocketeers: Artillery Rockets and Armed Groups*. Working Paper No. 19. Geneva: Small Arms Survey. July.

- . 2015a. *Missing Missiles: The Proliferation of Man-portable Air Defence Systems in North Africa*. SANA Issue Brief No. 2. Geneva: Small Arms Survey. June.
- . 2015b. 'MANPADS Collection Program Netted Hundreds of Missiles in Iraq, Documents Reveal.' Arms Trafficking, Arms Trade, and Weapons ID Docs. 17 July.
- . 2015c. 'Small Arms and RPGs Produced in Iran.' Arms Trafficking, Arms Trade, and Weapons ID Docs. 6 January.
- . 2015d. 'Newly Released Documents on Weapons Recovered in Afghanistan.' Arms Trafficking, Arms Trade, and Weapons ID Docs. 27 April.
- . 2016. *Drips and Drabs: The Mechanics of Small Arms Trafficking from the United States*. Issue Brief No. 17. Geneva: Small Arms Survey. March.
- , Helen Close, and Chris Stevenson. 2008. 'Deadly Deception: Arms Transfer Diversion.' In Small Arms Survey. *Small Arms Survey 2008: Risk and Resilience*. Cambridge: Cambridge University Press, pp. 112–53.
- and Benjamin King. 2012. 'Surveying the Battlefield: Illicit Arms in Afghanistan, Iraq, and Somalia.' In Small Arms Survey. *Small Arms Survey 2012: Moving Targets*. Cambridge: Cambridge University Press, pp. 312–55.
- Serino, Kenichi. 2015. 'The Human Victims in the Fight Over Rhino Poaching in Africa.' *Al Jazeera America*. 7 January.
- Shea, E. Daniel. 2007. 'Improvised Weapons of the Irish Underground (Ulster).' *Small Arms Review*. March.
- Sigler, Derrek. n.d. 'In-line Muzzleloaders Buyer's Guide.' *Cabela's*.
- SIPRI (Stockholm International Peace Research Institute). n.d. 'SIPRI Arms Transfers Database.'
- Small Arms Survey. n.d.a. 'Peace Operations Data Set.'
- n.d.b. 'The Transparency Barometer.'
- Soto, Arturo. 2009. 'IGLA- S /SA-24 Grinch- Manpads en Venezuela.' YouTube. Posted 19 April 2009.
- SPC (Sharretts Plating Company). n.d. 'What is Electroplating?'
- Steyn, Paul. 2016. 'African Elephant Numbers Plummet 30 Percent, Landmark Survey Finds.' *National Geographic*. 31 August.
- Syri Anwa. n.d. 'A Rebel Brigade with Three Different Models of MANPADS'. YouTube. Posted 1 June 2012.
- Taylor, John M. 2016. 'Looking Back at Shotgun History.' *American Rifleman*. 23 May.
- Telekanal ICTV. 2015. 'Khit-parad Feykov Nedeli: Stingery SShA v Luganske Antizombi, 24.07.' YouTube. Posted on 24 July.
- Tucker, Spencer C. 2015. *Instruments of War: Weapons and Technologies That Have Changed History*. Santa Barbara: ABC-CLIO.
- UK Defence Intelligence. 2010. 'The Insurgent Weapons Arsenal (Afghanistan).' Defense Intelligence Threat Statement. 2 December.
- UN (United Nations). 1980. *Convention on Prohibitions or Restrictions on the Use of Certain Conventional Weapons Which May be Deemed to be Excessively Injurious or to Have Indiscriminate Effects (and Protocols) (As Amended on 21 December 2001)*. 10 October.
- UNDPKO (United Nations Department of Peacekeeping Operations). 2018. 'Monthly Summary of Military and Police Contribution To United Nations Operations.' 31 March.

- UNGA (United Nations General Assembly). 2001a. Protocol against the Illicit Manufacturing of and Trafficking in Firearms, Their Parts and Components and Ammunition, Supplementing the United Nations Convention against Transnational Organized Crime ('UN Firearms Protocol'). Adopted 31 May. In force 3 July 2005. A/RES/55/255 of 8 June.
- . 2001b. Programme of Action to Prevent, Combat and Eradicate the Illicit Trade in Small Arms and Light Weapons in All Its Aspects ('Programme of Action'). A/CONF.192/15 of 20 July.
 - . 2003. *Continuing Operation of the United Nations Register of Conventional Arms and its Further Development*. A/58/274. 13 August.
 - . 2005. International Instrument to Enable States to Identify and Trace, in a Timely and Reliable Manner, Illicit Small Arms and Light Weapons ('International Tracing Instrument'). Adopted 8 December. A/60/88. 27 June (annex).
 - . 2006a. Resolution 61/77, adopted 6 December. A/RES/61/77 of 18 December 2006.
 - . 2006b. *Continuing Operation of the United Nations Register of Conventional Arms and its Further Development*. A/61/261. 15 August.
 - . 2010. *United Nations Register of Conventional Arms: Report of the Secretary-General*. A/65/133. 15 July.
 - . 2011. *United Nations Register of Conventional Arms: Report of the Secretary-General*. A/66/127. 12 July.
 - . 2013a. Arms Trade Treaty. Certified True Copy (XXVI-8). Adopted 2 April. In force 24 December 2014.
 - . 2013b. *United Nations Register of Conventional Arms: Report of the Secretary-General*. A/68/138. 15 July.
 - . 2015. Transforming Our World: The 2030 Agenda for Sustainable Development. Resolution 70/1 of 25 September. A/RES/70/1 of 21 October.
 - . 2016a. *Continuing Operation of the United Nations Register of Conventional Arms and its Further Development*. A/71/259. 29 July.
 - . 2016b. Resolution 71/44, adopted 5 December. A/RES/71/44 of 9 December 2016.
- UNODA (United Nations Office of Disarmament Affairs). 2007. *Guidelines for Reporting International Transfers: Questions and Answers*.
- UNROCA (United Nations Register of Conventional Arms). n.d.a. 'About UNROCA.'
- . n.d.b. Transparency in the Global Reported Arms Trade.
 - . n.d.c. 'UNROCA: Participation Statistics.'
- UNSC (United Nations Security Council). 2015. Final Report of the Panel of Experts Assisting the 1970 Libya Sanctions Committee. S/2015/128 of 23 February.
- . 2016. *Final Report of the Group of Experts on Côte d'Ivoire Pursuant to Paragraph 27 of Security Council Resolution 2219 (2015)*. S/2016/254. 17 March.
- UNSD (United Nations Statistics Division). n.d.a. 'Mirrors statistics.'
- . n.d.b. 'Data Disclaimer.'
 - . n.d.c. 'United Nations Commodity Trade Statistics Database.'
 - . 2008. *An Overview of National Compilation and Dissemination Practices*. July 2008.
- US AFRICOM (United States Africa Command). 2011. 'AFRICOM's Ham Testifies before the Senate Armed Services Committee.' Transcript. 7 April.
- US Army (Headquarters, Department of the Army). 1969. *Improvised Munitions Handbook*. Technical Manual TM 31-210. Washington, D.C.: Headquarters, Department of the Army.

- . 1982. *Hand Receipt Manual Covering Contents of Components of End Item (COEI), Basic Issue Items (BII) and Additional Authorization List (AAL) For Dragon Medium Antitank/Assault Weapon System*. Army Technical Manual TM 9-1425-484-10-HR. Washington, D.C.: United States Army. October.
 - . 1991. *Tactics, Techniques, and Procedures for Observed Fire*. FM 6-30. Washington, D.C.: United States Army.
 - . 2006. *The Infantry Battalion*. Field Manual No. 3-21.20. Washington, D.C.: United States Army.
 - . 2007. *Mortars*. Field Manual No. 3-22.90. Washington, D.C.: United States Army.
 - . 2010. *Site Exploitation Operations*. Field Manual No. 3-90.15. Washington, D.C.: United States Army. July.
- US Army TRADOC (Training and Doctrine Command). 1976. *Soviet RPG-7 Antitank Grenade Launcher*. TRADOC Bulletin No. 3. Fort Monroe: US Army TRADOC.
- US CBP (United States Customs and Border Protection). 2011. Documents obtained in response to a Freedom of Information Act request filed by the Small Arms Survey and the Federation of American Scientists for ‘a copy of all records from the Seized Asset and Case Tracking System (or current equivalent database) of outbound seizures of firearms and other weapons and military equipment seized at the US Border from January 1, 2009 to July 1, 2011’. Received on 29 September.
- US Census Bureau (United States Census Bureau). n.d. USA Trade Online. Accessed 15 August 2016.
- US DoD (United States Department of Defense). n.d. ‘Contracts.’ Accessed 25 August 2016.
- . 2009. *Department of Defense Design Criteria Standard: Ammunition Color Coding*. MIL-STD-709D. Picatinny: U.S. Army Armament Research, Development and Engineering Center (ARDEC).
 - . 2016. ‘Contracts.’ Release No: CR-107-16. 7 June.
 - . 2018. DOD Dictionary of Military and Associated Terms.
- US DoS (United States US Department of State). n.d. ‘MANPADS: Combating the Threat to Global Aviation.’
- USMC (Headquarters, United States Marine Corps). 2005. *Launcher, Assault Rocket, 83mm, (SMAW) MK 153 Mod 0*. Technical Manual. TM 08673A-10/1B. Washington, D.C.: Department of the Navy.
- USSR (USSR Ministry of Defence). 1946. *A Brief Guide to Cartridges for Weapons of the Soviet Army: Calibre 7.62, 12.7, and 14.5mm*. Moscow: Military Publishing House of the USSR.
- Vining, Miles. 2016. ‘The Interview: Chris Barrett, Part II.’ *Small Arms Review*, Vol. 20, No. 10.
- Vira, Varun and Thomas Ewing. 2014. ‘Ivory’s Curse: The Militarization and Professionalization of Poaching in Africa.’ *Born Free USA and C4ADS*. April.
- Vries, Marsha Simone de. 2011. ‘Converted Firearms: A Transnational Problem with Local Harm.’ *European Journal on Criminal Policy and Research*, Vol. 18, Issue 2. September 27, pp. 205–16.
- Wallace, James Smyth. 2008. *Chemical Analysis of Firearms, Ammunition, and Gunshot Residue*. Boca Raton: CRC Press.
- Warwick, Graham. 2008. ‘Raytheon Tests Bunker-busting Tandem Warhead.’ *Flight Global*. 26 February.
- WCO (World Customs Organization). 2012. *Explanatory Notes*, 5th edn.
- . 2017. ‘Chapter 90: Optical, Photographic, Cinematographic, Measuring, Checking, Precision, Medical or Surgical Instruments and Apparatus; Parts and Accessories Thereof.’ HS Nomenclature, 2017 edn.
- Wezeman, Siemon T. and Pieter D. Wezeman. 2015. *The 2015 UN Register on Conventional Arms: Still Time To Improve*. Commentary. Solna: Stockholm International Peace Research Institute. 18 September.

- Whittaker, John C. 2001. "The Oldest British Industry": Continuity and Obsolescence in a Flintknapper's Sample Set.' *Antiquity*, Vol. 75, Issue 288, 382–390.
- Williams, Anthony G. n.d. *Military Guns and Ammunition*. Website.
- . 2000. *Rapid Fire: The Development of Automatic Cannon, Heavy Machine Guns and their Ammunition for Armies, Navies and Air Forces*. Shrewsbury: Airlife.
- . 2007. 'An Introduction to Collecting 20 mm Cannon Cartridges.' Parts 1 and 2. *The Cartridge Researcher*. January/February editions.
- . 2015. *Introduction to Modern General-purpose Calibres*. Unpublished background paper. Perth: ARES.
- . 2016. *Mortar Ammunition: An International Survey*. Self-published.
- . 2017. *Grenade Launchers and their Ammunition: International Developments*. Self-published.
- Wirnsberger, Gerhard. 1985. *Standard Directory of Proofmarks*. Translated by R.A. Steindler. Chino Valley, AZ: Blacksmith Publishing Corporation.
- Wood Magazine. n.d. 'Understanding Wood Grain.'
- Y-Man. 2013a. 'Y-man Has a "FINALLY!" Moment with His New Slugs and New Stock...' *The Firearm Blog*. 13 September.
- . 2013b. 'The Shot Towers of Africa.' *The Firearm Blog*. 17 September.
- Yan, Timothy G. 2015. *The Chinese QLZ87 Automatic Grenade Launcher*. Arms and Munitions Brief No. 1. Perth: ARES.
- Yasin, Muhammad Ilyas. 2013. 'Obsolete Caliber 7.92x33mm AK Type Rifles Which Are Also Capable of Firing 7.62x39mm Cartridges.' *AFTE Journal*. Vol. 45, No. 3.
- van Zwoll, Wayne. 2014. *The Gun Digest Book of the Remington 700*. Iola: Gun Digest Books.

